

Mixed Signal Oscilloscopes

MSO2000 Series, DPO2000 Series Data Sheet

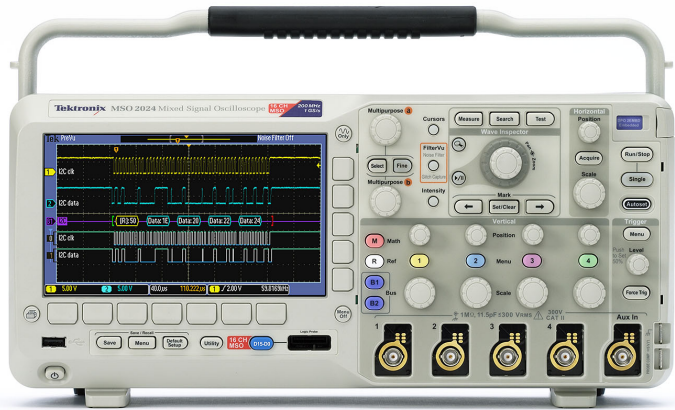

Features & Benefits

Key Performance Specifications

- 200, 100 MHz Bandwidth Models
- 2 and 4 Analog Channel Models
- 16 Digital Channels (MSO Series)
- 1 GS/s Sample Rate on All Channels
- 1 Megapoint Record Length on All Channels
- 5,000 wfms/s Maximum Waveform Capture Rate
- Suite of Advanced Triggers

Ease of Use Features

- Wave Inspector® Controls Provide Easy Navigation and Automated Search of Waveform Data
- FilterVu™ Variable Low-pass Filter Allows for Removal of Unwanted Signal Noise while still Capturing High-frequency Events
- 29 Automated Measurements, and FFT Analysis for Simplified Waveform Analysis
- TekVPI® Probe Interface Supports Active, Differential, and Current Probes for Automatic Scaling and Units
- 7 in. (180 mm) Widescreen TFT-LCD Color Display
- Small Footprint and Lightweight – Only 5.3 in. (134 mm) deep and 7 lb. 14 oz. (3.6 kg)

Connectivity

- USB 2.0 Host Port on the Front Panel for Quick and Easy Data Storage
- USB 2.0 Device Port on Rear Panel for Easy Connection to a PC or Direct Printing to a PictBridge®-compatible Printer
- Optional 10/100 Ethernet Port for Network Connection and Video Out Port to Export the Oscilloscope Display to a Monitor or Projector

Optional Serial Triggering and Analysis

- Automated Serial Triggering, Decode, and Search Options for I²C, SPI, CAN, LIN, and RS-232/422/485/UART

Mixed Signal Design and Analysis (MSO Series)

- Automated Triggering, Decode, and Search on Parallel Buses
- Multichannel Setup and Hold Triggering

Feature-rich Tools for Debugging Mixed Signal Designs

Offering up to 200 MHz bandwidth and 1 GS/s sample rate, the MSO/DPO2000 Mixed Signal Oscilloscope Series delivers advanced debug features at an entry-level price. With up to 20 channels for analyzing analog and digital signals, you can quickly find and diagnose problems in complex designs. To capture long windows of signal activity while maintaining fine timing resolution, the MSO/DPO2000 offers a deep record length of 1 Mpoints standard on all channels.

With Wave Inspector® controls for rapid waveform navigation and automated serial and parallel bus analysis, the MSO/DPO2000 Oscilloscope Series from Tektronix provides the feature-rich tools you need to simplify and speed debug of your complex design.

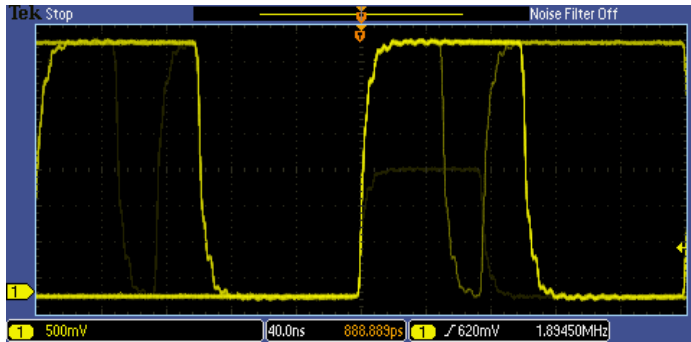

Discover – A waveform capture rate of 5,000 wfms/s maximizes the probability of capturing elusive glitches and other infrequent events.

Comprehensive Features Speed Every Stage of Debug

The MSO/DPO2000 Series offers a robust set of features to speed every stage of debugging your design – from quickly discovering an anomaly and capturing it, to searching your waveform record for the event and analyzing its characteristics and your device's behavior.

Discover

To debug a design problem, first you must know it exists. Every design engineer spends time looking for problems in their design, a time-consuming and frustrating task without the right debug tools.

The MSO/DPO2000 Series offers complete visualization of signals, providing fast insight into the real operation of your device. A waveform capture rate of 5,000 waveforms per second enables you to see glitches and other infrequent transients quickly, revealing the true nature of device faults. A digital phosphor display with intensity grading shows the history of a signal's activity by intensifying areas of the signal that occur more frequently, providing a visual display of just how often anomalies occur.

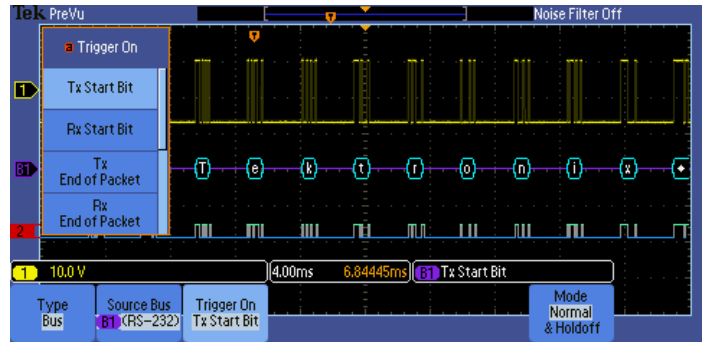

Capture – Triggering on a specific transmit data packet going across an RS-232 bus. A complete set of triggers, including triggers for specific serial packet content, ensures you quickly capture your event of interest.

Capture

Discovering a device fault is only the first step. Next, you must capture the event of interest to identify root cause.

The MSO/DPO2000 Series provides a complete set of triggers – including runt, logic, pulse width/glitch, setup/hold violation, serial packet, and parallel data – to help quickly find your event. With up to a 1 Mpoint record length, you can capture many events of interest, even thousands of serial packets, in a single acquisition for further analysis while maintaining high resolution to zoom in on fine signal details.

From triggering on specific packet content to automatic decode in multiple data formats, the MSO/DPO2000 Series provides integrated support for a broad range of serial buses – I²C, SPI, CAN, LIN, and RS-232/422/485/UART. The ability to decode up to two serial and/or parallel buses simultaneously means you gain insight into system-level problems quickly.

To further help troubleshoot system-level interactions in complex embedded systems, the MSO2000 Series offers 16 digital channels in addition to its analog channels. Since the digital channels are fully integrated into the oscilloscope, you can trigger across all input channels, automatically time-correlating all analog, digital, and serial signals.

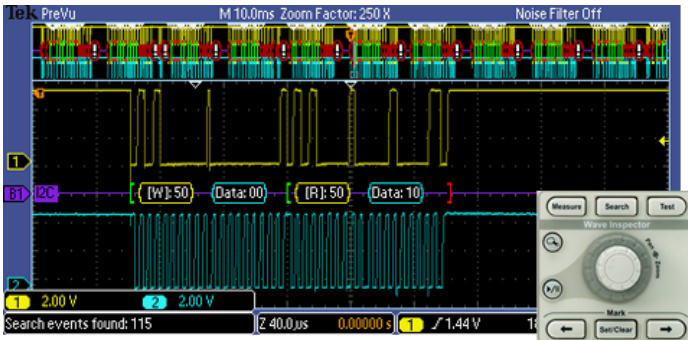

Search – I2C decode showing results from a Wave Inspector search for Address value 50. Wave Inspector controls provide unprecedented efficiency in viewing and navigating waveform data.

Search

Finding your event of interest in a long waveform record can be time consuming without the right search tools. With today's record lengths pushing to a million data points, locating your event can mean scrolling through thousands of screens of signal activity.

The MSO/DPO2000 Series offers the industry's most comprehensive search and waveform navigation with its innovative Wave Inspector® controls. These controls speed panning and zooming through your record. With a unique force-feedback system, you can move from one end of your record to the other in just seconds. User marks allow you to mark any location that you may want to reference later for further investigation. Or, automatically search your record for criteria you define. Wave Inspector will instantly search your entire record, including analog, digital, and serial bus data. Along the way it will automatically mark every occurrence of your defined event so you can quickly move between events.

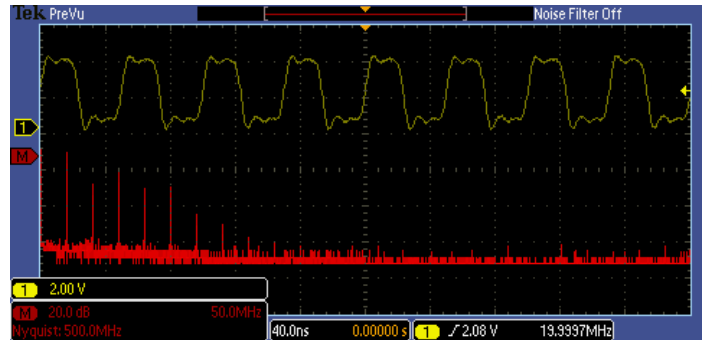

Analyze – FFT analysis of a pulsed signal. A comprehensive set of integrated analysis tools speeds verification of your design's performance.

Analyze

Verifying that your prototype's performance matches simulations and meets the project's design goals requires analyzing its behavior. Tasks can range from simple checks of rise times and pulse widths to sophisticated power loss analysis and investigation of noise sources.

The MSO/DPO2000 Series offers a comprehensive set of integrated analysis tools including waveform- and screen-based cursors, 29 automated measurements, and FFT analysis. Specialized application support for serial bus analysis is also available.

For extended analysis, National Instrument's LabVIEW SignalExpress™ Tektronix Edition provides over 200 built-in functions including time and frequency domain analysis, limit testing, data logging, and customizable reports.



Wave Inspector controls provide unprecedented efficiency in viewing, navigating, and analyzing waveform data. Zip through your 1 Mpoint record by turning the outer pan control (1). Get from the beginning to end in seconds. See something of interest and want to see more details? Just turn the inner zoom control (2).

Wave Inspector® Navigation and Search

A 1 Mpoint record length represents thousands of screens of information. The MSO/DPO2000 Series enables you to find your event in seconds with Wave Inspector, the industry's best tool for navigation and search.

Wave Inspector offers the following innovative controls:

Zoom/Pan

A dedicated, two-tier front-panel control provides intuitive control of both zooming and panning. The inner control adjusts the zoom factor (or zoom scale); turning it clockwise activates zoom and goes to progressively higher zoom factors, while turning it counterclockwise results in lower zoom factors and eventually turning zoom off. No longer do you need to navigate through multiple menus to adjust your zoom view. The outer control pans the zoom box across the waveform to quickly get to the portion of waveform you are interested in. The outer control also utilizes force-feedback to determine how fast to pan on the waveform. The farther you turn the outer control, the faster the zoom box moves. Pan direction is changed by simply turning the control the other way.

Play/Pause

A dedicated **Play/Pause** front-panel button scrolls the waveform across the display automatically while you look for anomalies or an event of interest. Playback speed and direction are controlled using the intuitive pan control. Once again, turning the control further makes the waveform scroll faster and changing direction is as simple as turning the control the other way.

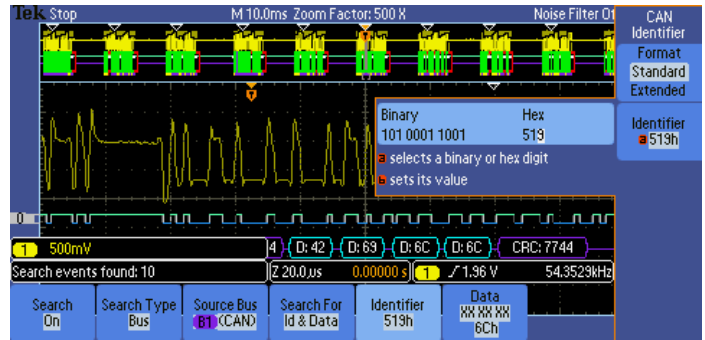

Search step 1: You define what you would like to find.

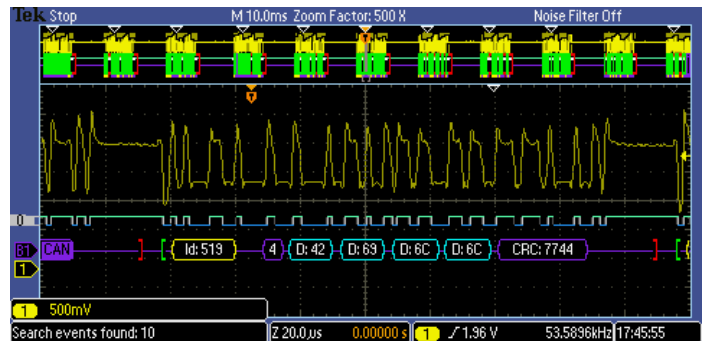

Search step 2: Wave Inspector automatically searches through the record and marks each event with a hollow white triangle. You can then use the **Previous** and **Next** buttons to jump from one event to the next.

User Marks

Press the **Set Mark** front-panel button to place one or more marks on the waveform. Navigating between marks is as simple as pressing the **Previous** (←) and **Next** (→) buttons on the front panel.

Search Marks

The **Search** button allows you to automatically search through your long acquisition looking for user-defined events. All occurrences of the event are highlighted with search marks and are easily navigated to, using the front-panel **Previous** (←) and **Next** (→) buttons. Search types include edge, pulse width/glitch, runt, logic, setup and hold, rise/fall time parallel bus, and I²C, SPI, CAN, LIN, and RS-232/422/485/UART packet content.

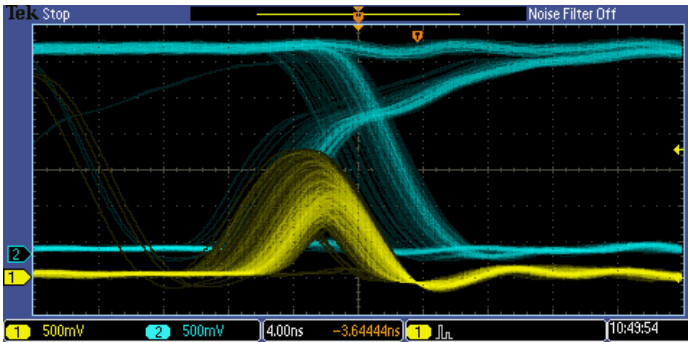

Digital phosphor technology enables a 5,000 wfms/s waveform capture rate and real-time intensity grading on the MSO/DPO2000 Series.

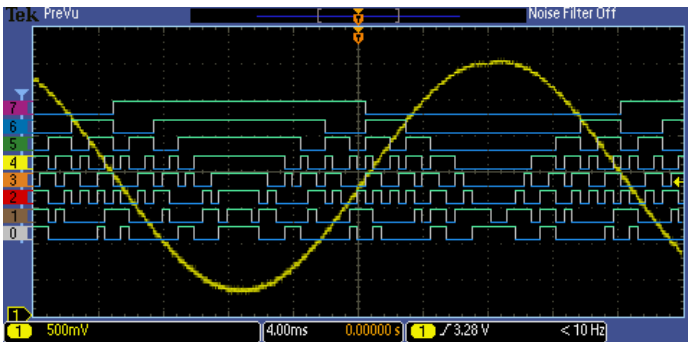

The MSO Series provides 16 integrated digital channels enabling you to view and analyze time-correlated analog and digital signals.

Digital Phosphor Technology

The MSO/DPO2000 Series' digital phosphor technology provides you with fast insight into the real operation of your device. Its waveform capture rate of 5,000 wfms/s gives you a high probability of quickly seeing the infrequent problems common in digital systems: runt pulses, glitches, timing issues, and more.

Waveforms are superimposed with one another and waveform points that occur more frequently are intensified. This quickly highlights the events

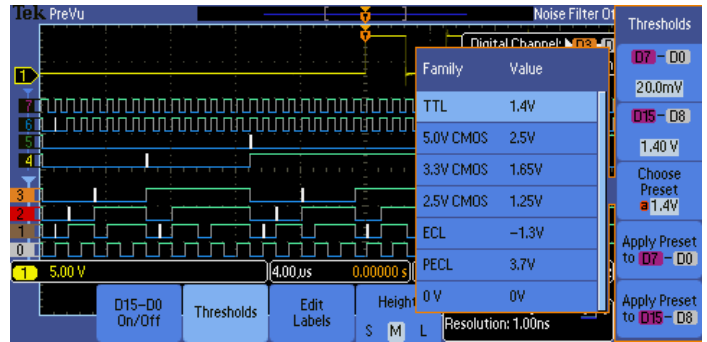

With the color-coded digital waveform display, groups are created by simply placing digital channels together on the screen, allowing the digital channels to be moved as a group. You can set threshold values for each pod of eight channels, enabling support for up to two different logic families.

that over time occur more often or, in the case of infrequent anomalies, occur less often.

With the MSO/DPO2000 Series, you can choose infinite persistence or variable persistence, determining how long the previous waveform acquisitions stay on-screen. This allows you to determine how often an anomaly is occurring.

Mixed Signal Design and Analysis (MSO Series)

The MSO2000 Series Mixed Signal Oscilloscopes provide 16 digital channels. These channels are tightly integrated into the oscilloscope's user interface, simplifying operation and making it possible to solve mixed-signal issues easily.

Color-coded Digital Waveform Display

The MSO2000 Series has redefined the way you view digital waveforms. One common problem shared by both logic analyzers and mixed-signal oscilloscopes is determining if data is a one or a zero when zoomed in far enough that the digital trace stays flat all the way across the display. The MSO2000 Series has color-coded digital traces, displaying ones in green and zeros in blue.



White edges indicate additional information is available by acquiring at a higher sample rate.



The P6316 MSO probe offers two eight-channel pods to simplify connecting to your device.

The multiple transition detection hardware of the MSO2000 Series will show you a white edge on the display when the system detects multiple transitions. This acts as a visual reminder that increasing the sample rate on the next acquisition will reveal higher frequency information than your previous settings could acquire.

The MSO2000 Series simplifies channel setup by allowing you to group digital waveforms and enter waveform labels by using a USB keyboard. By simply placing digital waveforms next to each other, they form a group. Once a group is formed, you can position all the channels contained in that group collectively. This greatly reduces the normal setup time associated with positioning channels individually.

P6316 MSO Probe

This unique probe design offers two eight-channel pods, simplifying the process of connecting to the device-under-test. When connecting to square pins, the P6316 can connect directly to 8×2 square pin headers spaced on tenth-inch centers. When more attachment flexibility is required, you can use the included flying lead sets and grabbers to clip onto surface mount devices or test points. The P6316 offers outstanding electrical characteristics applying only 8 pF of capacitive loading with 101 kΩ input impedance.

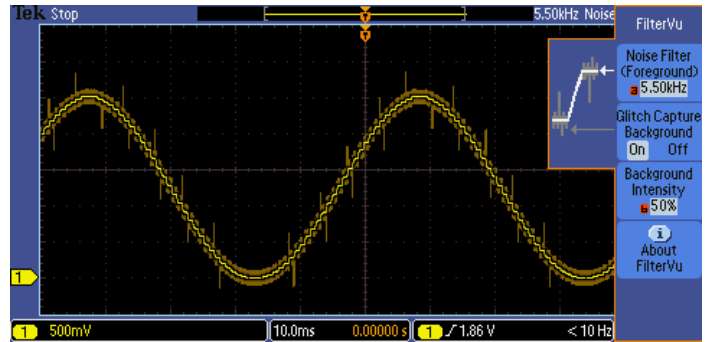

Output of DAC Signal – Notice how FilterVu™ clearly shows the noise-free steps of the DAC in the foreground trace (yellow) which has removed all frequencies above 5.5 kHz. FilterVu also captures and displays high-frequency glitches up to the full bandwidth of the oscilloscope in the background trace (orange).

FilterVu™ Variable Low-pass Filter

Tired of being limited to a 20 MHz bandwidth filter in your oscilloscope? Simply turn on FilterVu and adjust the variable low-pass noise filter. Unlike other variable low-pass filters, FilterVu filters out the unwanted noise from your signal while still capturing glitches and other signal details up to the full bandwidth of the oscilloscope. It does this by showing two waveforms: a waveform that can be filtered (foreground waveform) and a glitch capture waveform (background waveform).

The filtered waveform uses a variable low-pass filter to block out noise, yielding a cleaner waveform to more precisely locate signal edges and amplitude levels. The result is improved confidence in your cursor measurements and cleaner documentation of important signal attributes. When the noise filter is adjusted to the lowest available noise-cutoff frequency, no more than 1% of high-frequency content that could cause the oscilloscope to alias will pass through the filter.

The glitch capture waveform shows signal details up to the full bandwidth of the oscilloscope. The oscilloscope captures pulses as narrow as 5 ns, using peak-detect min/max sampling, protecting you from missing unexpected glitches or other high-frequency events.

FilterVu is ideal for repetitive, nonrepetitive, and single-shot events.

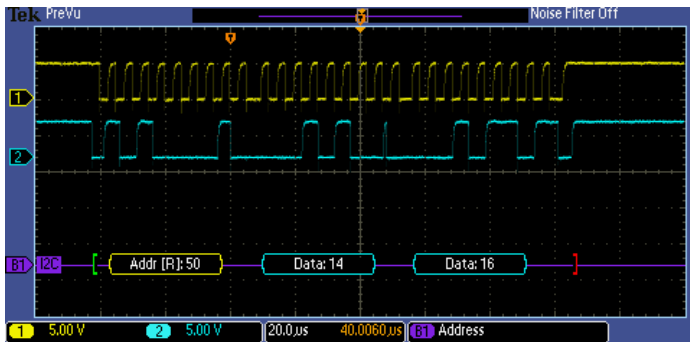

Triggering on a specific data packet going across an I²C bus. The yellow waveform is clock and the blue waveform is data. A bus waveform provides decoded packet content including Start, Address, Read/Write, Data, and Stop.

Serial Triggering and Analysis (Optional)

On a serial bus, a single signal often includes address, control, data, and clock information. This can make isolating events of interest difficult. The MSO/DPO2000 Series offers a robust set of tools for debugging serial buses with automatic trigger, decode, and search for I²C, SPI, CAN, LIN, and RS-232/422/485/UART.

Serial Triggering

Trigger on packet content such as start of packet, specific addresses, specific data content, unique identifiers, etc. on popular serial interfaces such as I²C, SPI, CAN, LIN, and RS-232/422/485/UART.

Bus Display

Provides a higher-level, combined view of the individual signals (clock, data, chip enable, etc.) that make up your bus, making it easy to identify where packets begin and end and identifying subpacket components such as address, data, identifier, CRC, etc.

Bus Decoding

Tired of having to visually inspect the waveform to count clocks, determine if each bit is a 1 or a 0, combine bits into bytes, and determine the hex value? Let the oscilloscope do it for you! Once you've set up a bus, the

Time	Identifier	DLC	Data	CRC	Missing Ack	Event Table
-44.33ms	1FFFFFFF	8	FFFF FFFF FFFF FFFF	1B69		Event Table
-39.61ms	BEBEBE	4	7B7E 9A9C	37EE		On Off
-39.40ms	100	0		380A		Save Event Table
-39.29ms	101	2	0103	562D		
-39.16ms	10000001	5	1122 3344 55	6A65		
-38.94ms	12345678	8	1122 3344 5566 7788	4C2		
-38.67ms	1537EEB2	8	FFFF 0000 EEEE 1111	216E		
-38.39ms	519	4	4269 6C6C	7744		
-38.23ms	1537EEB2	8	AE4F FFF1 0272 DF6B	2180		
-37.96ms	527DE32	1	11	7F3D		
-37.80ms	140014	3	1122 33	5EDC		
-37.61ms	160016	5	1122 3344 55	3911		
-37.39ms	18181818	7	F1F2 F3F4 F5F6 F7	5F9B		

Event table showing decoded Identifier, DLC, DATA, and CRC for every CAN packet in a long acquisition.

MSO/DPO2000 Series will decode each packet on the bus, and display the value in hex, binary, decimal (LIN only), or ASCII (RS-232/422/485/UART only) in the bus waveform.

Event Table

In addition to seeing decoded packet data on the bus waveform itself, you can view all captured packets in a tabular view much like you would see in a software listing. Packets are time stamped and listed consecutively with columns for each component (Address, Data, etc.).

Search

Serial triggering is very useful for isolating the event of interest, but once you've captured it and need to analyze the surrounding data, what do you do? In the past, users had to manually scroll through the waveform counting and converting bits and looking for what caused the event. With the MSO/DPO2000 Series, you can have the oscilloscope automatically search through the acquired data for user-defined criteria including serial packet content. Each occurrence is highlighted by a search mark. Rapid navigation between marks is as simple as pressing the **Previous** (←) and **Next** (→) buttons on the front panel.

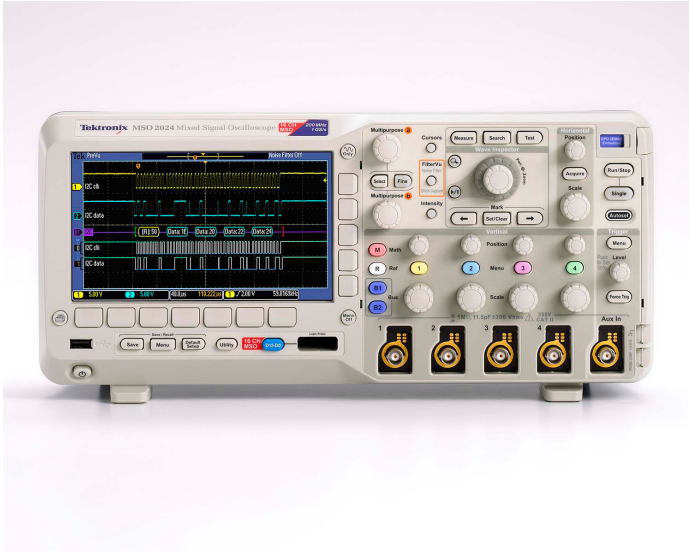

The MSO/DPO2000 is designed to make your work easier. The bright, widescreen display shows a long time window. Dedicated front-panel controls simplify operation. A USB host port on the front panel allows you to easily transfer screenshots, instrument settings, and waveform data to a memory stick.

Designed to Make Your Work Easier

Bright, Widescreen Display

The MSO/DPO2000 Series features a 7 inch (180 mm) widescreen, TFT-LCD display for seeing intricate signal details.

Dedicated Front-panel Controls

Per-channel vertical controls provide simple and intuitive operation. No longer do you need to share one set of vertical controls across all four channels.

Connectivity

A USB host port on the front panel enables easy transfer of screenshots, instrument settings, and waveform data to a USB thumb drive. The rear panel contains a USB device port for controlling the oscilloscope remotely from a PC or for connecting a USB keyboard. The USB device port can also be used to print directly to a PictBridge®-compatible printer. An optional 10/100 Ethernet port enables easy connection to networks and an optional Video Out port allows the oscilloscope display to be exported to an external monitor or projector.

Compact Form Factor

A compact, portable form factor allows the MSO/DPO2000 Series to be easily moved between labs and, with a depth of just 5.3 inches (134 mm), it saves you valuable space on your test bench.

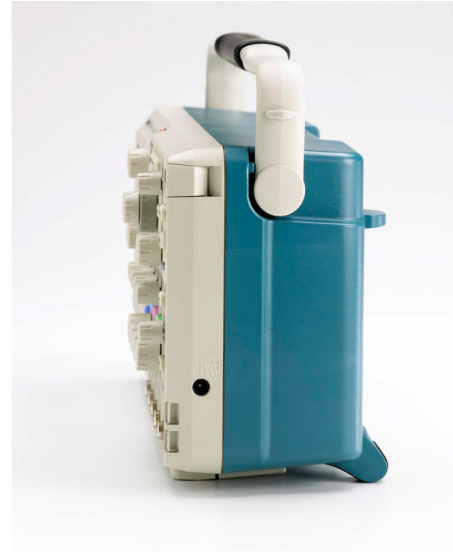

The MSO/DPO2000 Series' compact form factor frees up valuable space on your bench or desktop.

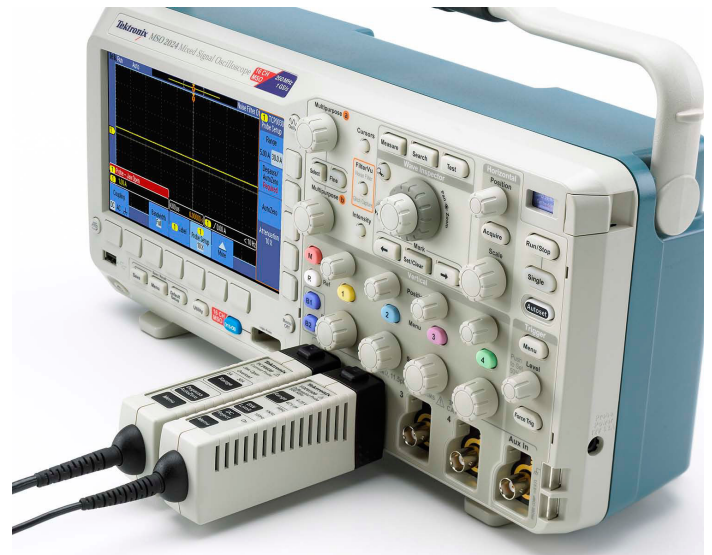

TekVPI probe interface simplifies connecting your probes to the oscilloscope.

TekVPI® Probe Interface

The TekVPI probe interface sets the standard for ease of use in probing. TekVPI probes feature status indicators and controls, as well as a probe menu button right on the comp box itself. This button brings up a probe menu on the oscilloscope display with all relevant settings and controls for the probe. TekVPI probes can be controlled remotely through USB, GPIB, or Ethernet, enabling more versatile solutions in ATE environments.

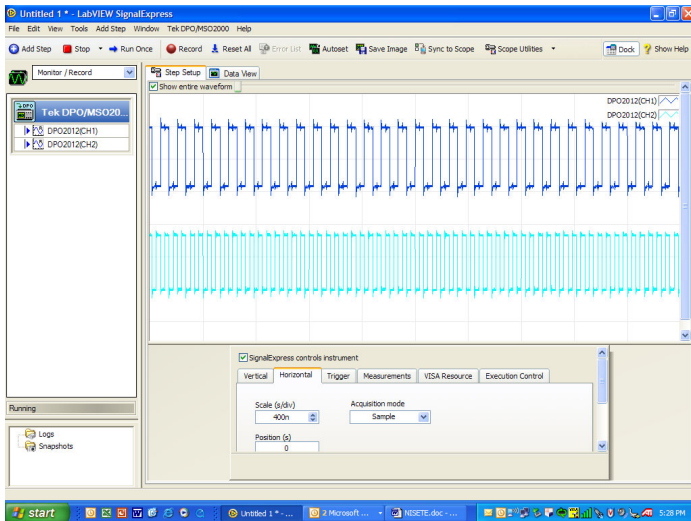

NI LabVIEW SignalExpress™ Tektronix Edition is a fully interactive measurement acquisition and analysis software developed jointly with National Instruments and optimized for the MSO/DPO Series.

Extended Analysis

Acquiring data and measurements from the MSO/DPO2000 Series is as simple as connecting a USB cable from the oscilloscope to your PC. Key software applications – NI LabVIEW SignalExpress™ Tektronix Edition LE, OpenChoice® Desktop, and Microsoft Excel and Word toolbars – are included standard with each oscilloscope to enable fast and easy direct communication with your Windows PC.

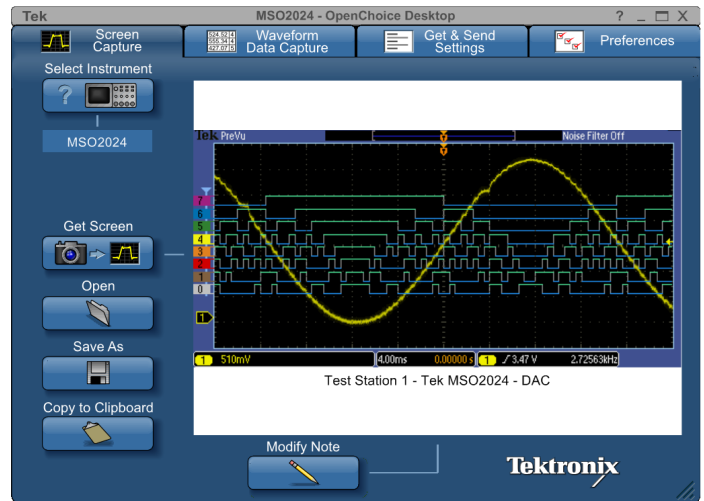

OpenChoice® Desktop software enables seamless connection between the oscilloscope and your PC.

NI LabVIEW SignalExpress Tektronix Edition LE enables you to instantly acquire, generate, analyze, compare, import, and save measurement data and signals using an intuitive drag-and-drop user interface that does not require any programming. The optional Professional Version offers over 200 built-in functions that provide additional signal processing, advanced analysis, sweeping, limit testing, and user-defined step capabilities.

For simple tasks, the included OpenChoice Desktop enables fast and easy communication between the oscilloscope and your PC through USB, GPIB, or LAN for transferring settings, waveforms, and screen images.

Characteristics

Vertical System Analog Channels

Characteristic	MSO2012 DPO2012	MSO2014 DPO2014	MSO2024 DPO2024
Input Channels	2	4	4
Analog Bandwidth (-3 dB)*1	100 MHz	100 MHz	200 MHz
Calculated Rise Time	3.5 ns	3.5 ns	2.1 ns
Hardware Bandwidth Limits	20 MHz		
Input Coupling	AC, DC, GND		
Input Impedance	1 M Ω \pm 2%, 11.5 pF \pm 2 pF		
Input Sensitivity Range	2 mV/div to 5 V/div		
Vertical Resolution	8 bits		
Maximum Input Voltage, 1 M Ω	300 V _{RMS} with peaks \leq \pm 450 V		
DC Gain Accuracy (with offset set to 0 V)	\pm 3% for 10 mV/div to 5 V/div \pm 4% for 2 mV/div to 5 mV/div		
Channel-to-Channel Isolation (Any Two Channels at Equal Vertical Scale)	\geq 100:1 at \leq 100 MHz		100:1 at \leq 200 MHz

*1 Bandwidth is 20 MHz at 2 mV/div, all models.

Offset Range

Range	1 M Ω
2 mV/div to 200 mV/div	\pm 1 V
>200 mV/div to 5 V/div	\pm 25 V

Vertical System Digital Channels

Characteristic	All MSO2000 Models
Input Channels	16 Digital (D15 to D0)
Thresholds	Threshold per set of 8 channels
Threshold Selections	TTL, CMOS, ECL, PECL, User Defined
User-defined Threshold Range	\pm 20 V
Maximum Input Voltage	\pm 40 V
Threshold Accuracy	\pm (100 mV +3% of threshold setting)
Maximum Input Dynamic Range	80 V _{pk-pk} (threshold setting dependent)
Minimum Voltage Swing	500 mV _{pk-pk}
Input Impedance	101 k Ω
Probe Loading	8 pF
Vertical Resolution	1 bit

Horizontal System Analog Channels

Characteristic	MSO2012/2014 DPO2012/2014	MSO2024 DPO2024
Maximum Sample Rate (all channels)	1 GS/s	
Maximum Record Length (all channels)	1 Mpoints	
Maximum Duration of Time Captured at Highest Sample Rate (all channels)	1 ms	
Time-base Range (s/div)	4 ns to 100 s	2 ns to 100 s
Time-base Delay Time Range	-10 divisions to 5000 s	
Channel-to-Channel Deskew Range	\pm 100 ns	
Time-base Accuracy	\pm 25 ppm	

Horizontal System Digital Channels

Characteristic	All MSO2000 Models
Maximum Sample Rate (when using any of channels D7-D0)	1 GS/s (1 ns resolution)
Maximum Sample Rate (when using any of channels D15-D8)	500 MS/s (2 ns resolution)
Maximum Record Length (all channels)	1 Mpoints
Minimum Detectable Pulse Width	5 ns
Channel-to-Channel Skew	2 ns typical

Trigger System

Characteristic	Description
Main Trigger Modes	Auto, Normal, and Single
Trigger Coupling	DC, HF reject (attenuates >85 kHz), LF reject (attenuates <65 kHz), noise reject (reduces sensitivity)
Trigger Holdoff Range	20 ns to 8 s
Trigger Signal Frequency Counter	Provides a higher accuracy means of identifying the frequency of trigger signals. Trigger Signal Frequency counter resolution is 6 digits.

Trigger Sensitivity

Characteristic	Description
Internal DC Coupled	0.4 divisions from DC to 50 MHz 0.6 divisions > 50 MHz to 100 MHz 0.8 divisions > 100 MHz to 200 MHz
External (Auxiliary Input)	200 mV from DC to 100 MHz, 1x attenuation

Trigger Level Range

Characteristic	Description
Any Channel	±4.92 divisions from center of screen
External (Auxiliary Input)	±6.25 V, 1x attenuation ±12.5 V, 10x attenuation

Trigger Modes

Mode	Description
Edge	Positive or negative slope on any channel or front-panel auxiliary input. Coupling includes DC, AC, HF reject, LF reject, and noise reject.
Pulse Width	Trigger on width of positive or negative pulses that are >, <, =, or ≠ a specified period of time.
Runt	Trigger on a pulse that crosses one threshold but fails to cross a second threshold before crossing the first again.
Logic	Trigger when any logical pattern of channels goes false or stays true for specified period of time. Any input can be used as a clock to look for the pattern on a clock edge. Pattern (AND, OR, NAND, NOR) specified for all analog and digital input channels defined as High, Low, or Don't Care.
Setup and Hold	Trigger on violations of both setup time and hold time between clock and data present on any of the input channels.
Rise/Fall Time	Trigger on pulse edge rates that are faster or slower than specified. Slope may be positive, negative, or either.
Video	Trigger on line number, all lines, odd, even, or all fields on NTSC, PAL, and SECAM video signals.
I ² C (optional)	Trigger on Start, Repeated Start, Stop, Missing ACK, Address (7 or 10 bit), Data, or Address and Data on I ² C buses up to 3.4 Mb/s.
SPI (optional)	Trigger on SS, MOSI, MISO, or MOSI and MISO on SPI buses up to 10.0 Mb/s.
CAN (optional)	Trigger on Start of Frame, Frame Type (data, remote, error, overload), Identifier (standard or extended), Data, Identifier and Data, End of Frame, Missing ACK, or Bit Stuffing Error on CAN signals up to 1 Mb/s. Data can be further specified to trigger on ≤, <, =, >, ≥, or ≠ a specific data value. User-adjustable sample point is set to 50% by default.
RS-232/422/485/UART (optional)	Trigger on Tx Start Bit, Rx Start Bit, Tx End of Packet, Rx End of Packet, Tx Data, Rx Data, Tx Parity Error, and Rx Parity Error.
LIN (optional)	Trigger on Sync, Identifier, Data, Identifier and Data, Wakeup Frame, Sleep Frame, Errors such as Sync, Parity, or Checksum Errors.
Parallel (available on MSO models only)	Trigger on a parallel bus data value.

Acquisition Modes

Mode	Description
Sample	Acquire sampled values.
Peak Detect	Captures glitches as narrow as 3.5 ns at all sweep speeds.
Averaging	From 2 to 512 waveforms included in average.
Roll	Scrolls waveforms right to left across the screen at sweep speeds slower than or equal to 40 ms/div.

Waveform Measurements

Measurement	Description
Cursors	Waveform and Screen.
Automatic Measurements	29, of which up to four can be displayed on-screen at any one time. Measurements include: Period, Frequency, Delay, Rise Time, Fall Time, Positive Duty Cycle, Negative Duty Cycle, Positive Pulse Width, Negative Pulse Width, Burst Width, Phase, Positive Overshoot, Negative Overshoot, Peak to Peak, Amplitude, High, Low, Max, Min, Mean, Cycle Mean, RMS, Cycle RMS, Positive Pulse Count, Negative Pulse Count, Rising Edge Count, Falling Edge Count, Area and Cycle Area.
Gating	Isolate the specific occurrence within an acquisition to take measurements on, using either the screen, or waveform cursors.

Waveform Math

Characteristic	Description
Arithmetic	Add, subtract, and multiply waveforms.
FFT	Spectral magnitude. Set FFT Vertical Scale to Linear RMS or dBV RMS, and FFT Window to Rectangular, Hamming, Hanning, or Blackman-Harris.

Software

Product	Description
NI LabVIEW SignalExpress™ Tektronix Edition	A fully interactive measurement software environment optimized for the MSO/DPO2000 Series, enables you to instantly acquire, generate, analyze, compare, import, and save measurement data and signals using an intuitive drag-and-drop user interface that does not require any programming. Standard MSO/DPO2000 Series support for acquiring, controlling, viewing, and exporting your live signal data is permanently available through the software. The full version (SIGEXPTE) adds additional signal processing, advanced analysis, mixed signal, sweeping, limit testing, and user-defined step capabilities and is available for a 30-day trial period standard with each instrument.
OpenChoice® Desktop	Enables fast and easy communication between a Windows PC and the MSO/DPO2000 Series. Transfer and save settings, waveforms, measurements, and screen images. Included Word and Excel toolbars automate the transfer of acquisition data and screen images from the oscilloscope into Word and Excel for quick reporting or further analysis.
IVI Driver	Provides a standard instrument programming interface for common applications such as LabVIEW, LabWindows/CVI, Microsoft .NET, and MATLAB.
eScope	Enables control of the MSO/DPO2000 Series over a network connection through a standard web browser. Simply enter the IP address or network name of the oscilloscope and a web page will be served to the browser.

Display Characteristics

Characteristic	Description
Display Type	7 in. (180 mm) liquid crystal TFT color display.
Display Resolution	480 horizontal × 234 vertical pixels (WQVGA).
Waveform Styles	Vectors, Dots (In Video Trigger mode), Variable Persistence, Infinite Persistence.
Graticules	Full, Grid, Cross Hair, Frame.
Format	YT and XY.
Maximum Waveform Capture Rate	Up to 5,000 wfm/s.

Input/Output Ports

Port	Description
USB 2.0 High-speed Host Port	Supports USB mass storage devices and keyboards. One port available front panel.
USB 2.0 High-speed Device Port	Rear-panel connector allows for communication/control of oscilloscope through USBTMC or GPIB with a TEK-USB-488, and direct printing to all PictBridge-compatible printers.
LAN Port	RJ-45 connector, supports 10/100Base-T (requires DPO2CONN).
Video Out Port	DB-15 female connector, connect to show the oscilloscope display on an external monitor or projector (requires DPO2CONN).
Auxiliary Input	Front-panel BNC connector. Input Impedance 1 MΩ ±2%. Max input 300 V _{RMS} CAT II with peaks ≤ ±450 V.
Probe Compensator Output	Front-panel pins Amplitude: 5 V Frequency: 1 kHz
Kensington Style Lock	Rear-panel security slot connects to standard Kensington-style lock.

Power Source

Characteristic	Description
Power Source Voltage	100 to 240 V ±10%
Power Source Frequency	45 to 65 Hz (90 to 264 V) 360 to 440 Hz (100 to 132 V)
Power Consumption	80 W maximum
Optional TekVPI® External Power Supply (119-7465-xx)	Output Voltage: 12 V Output Current: 5 A Power Consumption: 50 W

Physical Characteristics

Dimensions	mm	in.
Height	180	7.1
Width	377	14.9
Depth	134	5.3
Weight	kg	lb.
Net	3.6	7.9
Shipping	6.2	13.7
Rackmount Configuration	4U	
Cooling Clearance	2 in. (50 mm) required on left side and rear of instrument	

Environmental

Characteristic	Description
Temperature	
Operating	0 °C to +50 °C
Nonoperating	-40 °C to +71 °C
Humidity	
Operating	High: 30 °C to 50 °C, 5% to 60% Relative Humidity Low: 0 °C to 30 °C, 5% to 95% Relative Humidity
Nonoperating	High: 30 °C to 55 °C, 5% to 60% Relative Humidity Low: 0 °C to 30 °C, 5% to 95% Relative Humidity
Altitude	
Operating	3,000 meters (9,843 feet)
Nonoperating	12,000 meters (39,370 feet)
Random Vibration	
Operating	0.31 G _{RMS} from 5 to 500 Hz, 10 minutes each axis, 3 axes, 30 minutes total
Nonoperating	2.46 G _{RMS} from 5 to 500 Hz, 10 minutes each axis, 3 axes, 30 minutes total
Regulatory	
Electromagnetic Compatibility	EC Council Directive 2004/108/EC
Safety	UL61010-1:2004; CAN/CSA C22.2 No. 61010.1-04; EN61010-1:2001; Complies with the Low Voltage Directive 2004/108/EC for Product Safety.

Ordering Information

DPO2000 Models

Product	Description
DPO2012	100 MHz, 1 GS/s, 1M record length, 2-channel digital phosphor oscilloscope
DPO2014	100 MHz, 1 GS/s, 1M record length, 4-channel digital phosphor oscilloscope
DPO2024	200 MHz, 1 GS/s, 1M record length, 4-channel digital phosphor oscilloscope

MSO2000 Models

Product	Description
MSO2012	100 MHz, 1 GS/s, 1M record length, 2+16 channel mixed-signal oscilloscope
MSO2014	100 MHz, 1 GS/s, 1M record length, 4+16 channel mixed-signal oscilloscope
MSO2024	200 MHz, 1 GS/s, 1M record length, 4+16 channel mixed-signal oscilloscope

All Models Include: One P2221 200 MHz, 1x/10x Passive Probe per Analog Channel, User Manual and Translated Front-panel Overlay, Documentation CD (063-4118-xx), OpenChoice® Desktop Software, NI LabVIEW SignalExpress™ Tektronix Edition LE Software, Calibration certificates document measurement traceability to National Metrology Institute(s) and ISO9001 Quality System Registration, Power Cord, and a three-year warranty. Please specify power plug and manual version when ordering.

MSO Models also Include: One P6316 16-channel logic probe and accessory kit, and accessory bag (016-2008-xx).

Application Modules

Modules	Description
DPO2AUTO	Automotive Serial Triggering and Analysis Module. Enables triggering on packet-level information on CAN bus and LIN bus as well as analytical tools such as digital views of the signal, bus views, packet decoding, search tools, and packet decode tables with time stamp information.
DPO2COMP	Computer Serial Triggering and Analysis Module. Enables triggering on packet-level information on RS-232/422/485/UART buses as well as analytical tools such as digital views of the signal, bus views, packet decoding, search tools, and packet decode tables with time stamp information.
DPO2EMBD	Embedded Serial Triggering and Analysis Module. Enables triggering on packet-level information on I ² C and SPI buses as well as analytical tools such as digital views of the signal, bus views, packet decoding, search tools, and packet decode tables with time stamp information. Only two-wire SPI support available on DPO2012, MSO2012 models.

Instrument Options

Power Plug Options

Option	Description
Opt. A0	North America
Opt. A1	Universal Euro
Opt. A2	United Kingdom
Opt. A3	Australia
Opt. A5	Switzerland
Opt. A6	Japan
Opt. A10	China
Opt. A11	India
Opt. A99	No power cord

Language Options*2

Option	Description
Opt. L0	English manual
Opt. L1	French manual
Opt. L2	Italian manual
Opt. L3	German manual
Opt. L4	Spanish manual
Opt. L5	Japanese manual
Opt. L6	Portuguese manual
Opt. L7	Simplified Chinese manual
Opt. L8	Traditional Chinese manual
Opt. L9	Korean manual
Opt. L10	Russian manual
Opt. L99	No manual

*2 Language options include translated front-panel overlay for the selected language(s).

Service Options*3

Option	Description
Opt. C3	Calibration Service 3 years.
Opt. C5	Calibration Service 5 years.
Opt. CA1	Provides a single calibration event, or coverage for the designated calibration interval, whichever comes first.
Opt. D1	Calibration Data Report.
Opt. D3	Calibration Data Report 3 years (with Opt. C3).
Opt. D5	Calibration Data Report 5 years (with Opt. C5).
Opt. R5	Repair Service 5 years (including warranty).

*3 Probes and accessories are not covered by the oscilloscope warranty and Service Offerings. Refer to the datasheet of each probe and accessory model for its unique warranty and calibration terms.

Recommended Probes

Probe	Description
TAP1500*4	1.5 GHz TekVPI® single-ended active probe.
TDP0500*4, 6	500 MHz TekVPI 42 V differential probe.
TCP0030*4	120 MHz TekVPI 30 Ampere AC/DC current probe.
TCP0150*4	20 MHz TekVPI 150 Ampere AC/DC current probe.
TCPA300/400*7	Current measurement system amplifiers.
TCP305	DC to 50 MHz, 50 Ampere current probe for use with TCPA300.
TCP404XL	DC to 2 MHz, 500 Ampere current probe for use with TCPA400.
P5100	2.5 kV, 100x high-voltage passive probe.
P5200	1.3 kV, 50x/500x, 25 MHz high-voltage active differential probe.
P5205*4, 5	1.3 kV, 100 MHz high-voltage differential probe.
P5210*4, 5	5.6 kV, 50 MHz high-voltage differential probe.
ADA400A*4, 5	100x, 10x, 1x, 0.1x high-gain differential amplifier.

Recommended Accessories

Accessory	Description
DPO2CONN	Adds Ethernet (10/100Base-T) and Video Out Port
071-2331-xx	Service Manual (English only)
TPA-BNC*4	TekVPI to TekProbe BNC adapter
TEK-DPG*4	TekVPI Deskew Pulse Generator Signal Source
067-1686-xx	Deskew and Calibration Fixture
196-3508-xx	Digital Probe Leadset (8 channels)
119-7465-xx	TekVPI® External Power Supply
SIGEXPT	NI LabVIEW SignalExpress Tektronix Edition Software – Full Version
TEK-USB-488	GPIO-to-USB adapter
ACD2000	Soft Transit Case and Front Protective Cover
200-5045-xx	Front Protective Cover
HCTEK4321	Hard Transit Case (requires ACD2000)
RMD2000	Rackmount Kit. Does not include slide-out rails.

*4 Requires TekVPI external power adapter (119-7465-00); one per oscilloscope.

*5 Requires TPA-BNC adapter.

*6 Probes terminate into 50 Ω but oscilloscope will automatically adjust to account for 1 MΩ input.

*7 Requires 50 Ω feed through termination between the oscilloscope input and the BNC cable.

Warranty

Three-year warranty covering all parts and labor, excluding probes.



Product(s) are manufactured in ISO registered facilities.



Product(s) complies with IEEE Standard 488.1-1987, RS-232-C, and with Tektronix Standard Codes and Formats.

Contact Tektronix:

ASEAN / Australasia (65) 6356 3900
Austria +41 52 675 3777
Balkans, Israel, South Africa and other ISE Countries +41 52 675 3777
Belgium 07 81 60166
Brazil +55 (11) 40669400
Canada 1 (800) 661-5625
Central East Europe, Ukraine, and the Baltics +41 52 675 3777
Central Europe & Greece +41 52 675 3777
Denmark +45 80 88 1401
Finland +41 52 675 3777
France +33 (0) 1 69 86 81 81
Germany +49 (221) 94 77 400
Hong Kong (852) 2585-6688
India (91) 80-42922600
Italy +39 (02) 25086 1
Japan 81 (3) 6714-3010
Luxembourg +44 (0) 1344 392400
Mexico, Central/South America & Caribbean 52 (55) 54247900
Middle East, Asia, and North Africa +41 52 675 3777
The Netherlands 090 02 021797
Norway 800 16098
People's Republic of China 86 (10) 6235 1230
Poland +41 52 675 3777
Portugal 80 08 12370
Republic of Korea 82 (2) 6917-5000
Russia & CIS +7 (495) 7484900
South Africa +27 11 206 8360
Spain (+34) 901 988 054
Sweden 020 08 80371
Switzerland +41 52 675 3777
Taiwan 886 (2) 2722-9622
United Kingdom & Ireland +44 (0) 1344 392400
USA 1 (800) 426-2200

For other areas contact Tektronix, Inc at: 1 (503) 627-7111

Updated 30 October 2008

For Further Information. Tektronix maintains a comprehensive, constantly expanding collection of application notes, technical briefs and other resources to help engineers working on the cutting edge of technology. Please visit www.tektronix.com



Copyright © Tektronix, Inc. All rights reserved. Tektronix products are covered by U.S. and foreign patents, issued and pending. Information in this publication supersedes that in all previously published material. Specification and price change privileges reserved. TEKTRONIX and TEK are registered trademarks of Tektronix, Inc. All other trade names referenced are the service marks, trademarks, or registered trademarks of their respective companies.

20 May 2009

3GW-22048-1

