

Catalog 500

Main Switches	16 A-315 A
Maintenance Switches	20 A-315 A
Switch Disconnectors	20 A-315 A



KRAUS & NAIMER

The development of the Blue Line rotary switch, contactor and motor starter product ranges is based on more than seventy-five years experience by Kraus & Naimer in the design and manufacture of electrical switchgear. Kraus & Naimer pioneered the introduction of the cam operated rotary switch and continues to be recognized as the world leader in that product field.

BLUE LINE

Blue Line products are protected by numerous patents throughout the industrial world. They are built to national and international standards and designed to withstand adverse temperatures and climates.

Blue Line products are accepted and universally recognized for their quality and workmanship. They are supported by a worldwide sales and service organization.

The Kraus & Naimer Registered Trademark



WORLDWIDE SYMBOL
FOR QUALITY SWITCHGEAR

Contents

Page

Miscellaneous

Construction Data	2
Selection of the Main Switches	2
Standard Equipment	2
Mounting Units	3
Technical Data	4, 5
Lateral mounted Auxiliary Contacts, Protective Covers	34
Add-on Escutcheon Plates	35
Terminals for Control Circuit, Unlock Insert, Mounting Key	36
Connecting Diagrams	37

Main Switches and Main Switches with Emergency Function

2 and 3 pole	6-9
4 pole	10-13
3 pole with Ground and Neutral Terminal	14-17
3 pole and Auxiliary Contact	18-21
3 pole with Under-voltage Release	22
4 pole with Under-voltage Release	23

Maintenance and Safety Switches

(Main Switches and Main Switches with Emergency Function in Plastic Enclosure)

3 pole	24
3 pole and Auxiliary Contacts	25
4 pole	26
4 pole and Auxiliary Contacts	27
6 pole	28
6 pole and Auxiliary Contacts	29

Switch Disconnectors

3 pole	30
4 pole	31
6 pole	32
3 pole (Double-throw Switches)	32

Switch Disconnectors in Plastic Enclosure

3, 4, and 6 pole	33
------------------	----

Dimensions

Switches for Panel Mounting	38, 40
Switches for Base Mounting	39
Switches in Plastic Enclosure	41

Main Switches with 4 poles and also Maintenance Switches with 6 poles and more on request.

Switch disconnectors of the KG-series

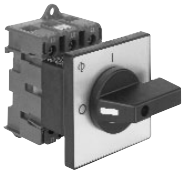

Switch disconnectors of the KH-series

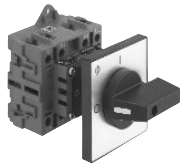

Main switches of the KG- and KH-series
2 designs



Main switches C316

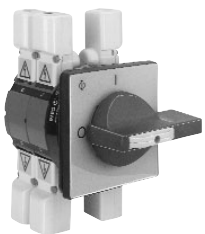

Maintenance and safety switches
2 designs



Construction Data

The switches described in this catalog exceed the requirements of IEC 60947-3, EN 60947-3, VDE 0660 part 107, IEC 60204, EN 60204 and VDE 0113 and meet the standard on switch disconnectors, main switches and maintenance switches.

Common characteristics of the modular switch line KG and KH are:

High circuit withstand capability and greater air and creepage distances for circuits up to 1000 V resp. 690 V. Positive contact movement during making and breaking operations.

Base mounted switches up to 100 A are designed for standard rail mounting in accordance with EN 50022. For ease of installation, switch terminations are on the same plane as the power conductors and are supplied with open terminals. Captive plus-minus terminal screws and integrated screwdriver guides also reduce wiring time.

Terminals on the KG10 through KG160 and the KH-series are all finger-proof in accordance with VDE 0106 part 100, with additional protection IP 20 (all-around finger-proof) on the KG10 through KG64 resp. KH40.

The switches of the KH-series are also available with adjustable length through shaft and for connecting with ring type terminals. KG125, KG160, KG210, KG250 and KG315 can be supplied with bolt terminals either on top or with terminals on the top and bottom.

C type switches used as main switches require a protective cover for the outgoing and incoming terminals.

Enclosures for the C and KG type switches are made of a strong durable plastic with high UV-resistance and are designed with extra space for easy wiring. A special enclosure series which is suitable for applications in an aggressive environment, such as oil, chemical substances and grease is also available.

Selection of the Main Switches

The regulations of VDE 0113 part 1 resp. EN 60204-1 indicate a difference between switch disconnectors and disconnectors when selecting the main switch.

Switch disconnectors have to conform to category AC-23B. The disconnector must have an auxiliary contact which ensures the load interruption by means of contactor. The disconnector, therefore, should be selected according to the thermal current of the load. The auxiliary contact must have a sufficient AC-15 switching capacity to operate the contactor.

When using the switch disconnector as a main switch the breaking capacity of the switch has to be considered. The interruption capacity of the switch must equal or exceed the locked rotor current of the machine's largest motor plus the total current of all other electrical equipment in the circuit. In addition, the total nominal current of all electrical equipment may not exceed the rated thermal current of the switch.

Standard Equipment

Main Switches and Main Switches with Emergency Function:

Are supplied with a padlockable handle and protective cover for all the incoming terminals for switch types C316, KG80 through KG315, KH63 and KH80. Switch types C316, KG210, KG250 and KG315 are also supplied with protective covers on the outgoing terminals.

Main switches are fitted with black handles. Main switches with emergency function are supplied with red handles and contrasting yellow escutcheon plate.

Switches with door clutches are also supplied with a padlock device.

Switches with under-voltage release are supplied with a coil for 220 V-230 V, 50 Hz.

(Other coil voltages are available on request.)

Maintenance and Safety Switches (Main Switches and Main Switches with Emergency Function in Enclosure):

High strength durable plastic enclosures are designed with extra space for easy wiring (see Construction Data), totally insulated acc. to IEC 364-4-41, HD 384.4.41 S2 and VDE 0100-410.

Main switches are fitted with electro-gray or black handles. Main switches with emergency function are supplied with red handles and contrasting yellow escutcheon plate.

Ground terminal.

Special safety interlocked covers supplied with enclosures.

Switches with code numbers ending with STM are supplied with conduit entries.





Notes:

Auxiliary contacts close after the main contacts close and open before main contacts open. A selection of padlock devices are shown on page 3.

Main switches with 4 poles and also maintenance switches with 6 poles and more on request.

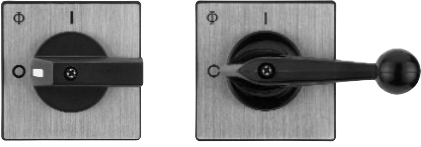
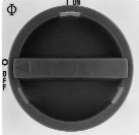
Ordering Information

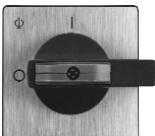
Ordering information is shown in blue on pages 6-35.

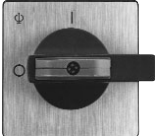

Mounting Units Switch disconnectors Main switches and main switches with emergency function with padlock device	Size in mm	Padlocks Max. Pad-lock Shackle in mm		Standard for Switch Types Further variations on request.
 <p style="text-align: center;">KG210, KG250, KG315</p>	48 x 48 64 x 64 88 x 88 130 x 130	– – – – – – – –	Four hole panel mounting, base mounting KG10A, KG 20A, KG32A, KG41, KG64, KH16, KH20, KH25 Single hole mounting 22 mm KG10A, KG20A, KG32A, KH16, KH20, KH25 Direct-mounting on printed circuit board KG21A, KG33A Four hole panel mounting, base mounting KG10B, KG20B, KG32B, KG41B, KG64B, KG80, KG100, KH16B, KH20B, KH25B, KH32, KH40, KH63, KH80 KG80C, KG100C, KG125, KG160, KG210, KG250, KG315 C316	
	74 x 74	3 9	In enclosure KG10, KG20, KG20B, KG32, KG32B, KG41, KG41B, KG64, KG64B, KG80, KG100	
	64 x 64 88 x 88	3 9 3 10	Four hole panel mounting, base mounting KG10B, KG20B, KG32B, KG41B, KG64B, KG80, KG100, KH16B, KH20B, KH25B, KH32, KH40, KH63, KH80, CA10Z, CA20Z, CA25Z, C32, C42 Single hole mounting 22 mm KG10B, KG20B, KG32B, KH16, KH20, KH25, KH32, KH40 Four hole panel mounting KG80C, KG100C, KG125, KG160 Base mounting KG125, KG160 In enclosure KG80C, KG100C, KG125, KG160	
	48 x 48 64 x 64 88 x 88 130 x 130	3 7 or 4 5 3 8 or 4 5 4 9 4 9	Four hole panel mounting, base mounting KG10A, KG20A, KG32A, KG41, KG64, KH16, KH20, KH25, CA10Z, CA20Z, CA25Z Single hole mounting 22 mm KG10A, KG20A, KG32A, KH16, KH20, KH25, CA10Z, CA20Z, CA25Z Four hole panel mounting or Single hole mounting 22 mm, base mounting KG10B, KG20B, KG32B, KG41B, KG64B, KG80, KG100, KH16B, KH20B, KH25B, KH32, KH40, KH63, KH80, CA10Z, CA20Z, CA25Z In enclosure KG10, KG20, KG20B, KG32, KG32B, KG41, KG41B, KG64, KG64B, KG80, KG100 Four hole panel mounting KG80C, KG100C, KG125, KG160, KG210, KG250, KG315 KG41B T..3/81 E, KG64B T..3/81 E In enclosure KG80C, KG100C, KG125, KG160, KG250, KG315 Four hole panel mounting and in enclosure C316	
	88 x 88	4 9	Four hole panel mounting KG250, KG315	
	88 x 88	3 9	Base mounting KG20B, KG32B, KG41B, KG64B, KG80, KG100, KG125, KG160, KG210, KG250, KG315, KH32, KH40, KH63, KH80, C316 With integrated door clutch. The handle is restricted if the door is opened. In the I-position the door can be opened with a special key. Possible misalignment of the shaft can be compensated for by the door clutch. To open the door in the I-position an unlock insert S1D M700 29 is available on request.	

Technical Data in accordance with IEC 60947, EN 60947, VDE 0660, IEC 60204, EN 60204, VDE 0113 <small>Nominal ratings for North America (UL) see Catalog 150⁶.</small>			KG10 KG10A KH16 KG10B KH16B		KG20 KG20A KH20 KG20B KH20B		KG25 KG25A KH25 KG25B KH25B		KG32 KG32A KH32 KG32B KH32		KG41 KG41B KH40		KG64 KG64B
Rated Values													
Insulation voltage U_i^1	V	690	800 ²	690	800 ²	800 ²	690	800 ²	690	800 ²	690		
Impulse withstand voltage U_{imp}^1	kV	4	6	6	6	6	6	6	6	6	6		
Thermal current $I_{u\ open} = I_{th}$	A	20	16	25	20	25	32	32	40	40	63		
	$I_{the\ enclosed}$	A	20	16	25	20	25	32	32	40	40	63	
Breaking capacity	220 V/240 V	A	120	160	180	200	250	220	300	300	380	350	
	380 V/440 V	A	120	160	180	200	250	220	300	300	380	350	
	660 V/690 V	A	80	160	125	160	180	135	210	150	230	190	
Main Switch Voltage Rating													
Disconnection property up to ¹	V	690	690	690	690	690	690	690	690	690	690		
Utilization Category													
AC-21A Switch disconnectors for resistive load I_e	A	20	16	25	20	25	32	32	40	40	63		
AC-3 Direct switching of single motors	3 phase, 3 pole												
	220 V/240 V	kW	2,2	3	4	3,5	4	5,5	5,5	7,5	7,5	11	
	380 V/440 V	kW	3,7	5,5	5,5	6,5	7,5	7,5	11	11	15	18,5	
	660 V/690 V	kW	3,7	5,5	5,5	6,5	7,5	7,5	11	11	15	15	
	1 phase, 2 pole												
	220 V/240 V	kW	1,1										
380 V/440 V	kW	1,5											
AC-23A, Switch disconnectors for motor circuits, main switches etc.	3 phase, 3 pole												
	220 V/240 V	kW	3	4,5	5,5	5,5	7	5,5	9	7,5	11	11	
	380 V/440 V	kW	5,5	7,5	7,5	10	12	11	16	15	20	22	
	660 V/690 V	kW	5,5	13	7,5	15	17	11	22	15	25	18,5	
	1 phase, 2 pole												
	220 V/240 V	kW	1,5										
380 V/440 V	kW	2,2											
Short Circuit Protection													
Max. fuse size (gL-characteristic)	A	20	25	35	35	35	35	35	50	50	63		
Rated short-time withstand current (1s-current)	A	130	400	350	450	500	430	850	500	950	580		
Max. Permissible Wire Gage⁷													
Single-core or stranded wire	mm ²	2,5	6	6	6	6	6	10	16	10	16		
	AWG	12	10	10	10	10	10	8	6	8	6		
	MCM	–	–	–	–	–	–	–	–	–	–		
Flexible wire with sleeve	mm ²	2,5	4	4	4	4	4	6	10	6	10		
	AWG	12	12	10	12	12	10	10	8	10	8		
	MCM	–	–	–	–	–	–	–	–	–	–		
Connecting bolts	mm	–	–	–	–	–	–	–	–	–	–		
Flat copper busbar	mm	–	–	–	–	–	–	–	–	–	–		
Auxiliary Contacts Rated Values													
Insulation voltage U_i^1	V	690	440	500	440	440	500	440	690	440	690		
Impulse withstand voltage U_{imp}^1	kV	4	4	6	4	4	6	4	6	4	6		
Thermal current $I_{u\ open} = I_{th}$	A	20	10	10	10	10	10	10	16	10	16		
	$I_{the\ enclosed}$	A	20	10	10	10	10	10	16	10	16		
AC-15 Operational current I_e	220 V/240 V	A	6	2,5	2,5	2,5	2,5	2,5	6	2,5	6		
	380 V/440 V	A	4	1,5	1,5	1,5	1,5	1,5	3	1,5	3		
Short Circuit Protection													
Max. fuse size (gL-characteristic)	A	20	10	10	10	10	10	10	16	10	16		
Max. Permissible Wire Gage⁷													
Single-core or stranded wire	mm ²	2,5	1,5	1,5	1,5	1,5	1,5	1,5	2,5	1,5	2,5		
	AWG	12	14	14	14	14	14	14	12	14	12		
Flexible wire with sleeve	mm ²	2,5	1,5	1,5	1,5	1,5	1,5	1,5	2,5	1,5	2,5		
	AWG	12	16	16	16	16	16	16	14	16	14		

KH63	KG80		KG100											
	KG80C	KH80	KG100C	KG125	KG160	KG210	KG250	KG315	CA10Z	CA20Z	CA25Z	C32	C42	C316
1000 ² 8	690 6	1000 ² 8	690 6	1000 ² 8	1000 ² 8	1000 ² 8	1000 ² 8	1000 ² 8	690 4	690 4	690 4	690 4	690 4	1000 8
63 63	80 80	80 80	100 100	125 125	160 160	200 200	250 250	315 315	20 20	25 25	32 32	50 50	63 63	315 315/275 ³
550 500 280	560 560 200	650 630 340	700 650 280	800 750 340	900 850 340	1300 1100 400	1600 1380 400	1800 1650 400	150 150 80	200 200 125	280 250 150	380 360 270	550 550 430	2000 2000 335
1000 ²	690	1000 ²	690	1000 ²	1000 ²	1000 ²	1000 ²	1000 ²	690	690	690	690	690	1000
63	80	80	100	125	160	200	250	315	20	25	32	40	63	315
11 22 18,5	15 22 18,5	15 30 22	18,5 30 22	22 37 30	30 45 37	37 55 45	37 55 45	45 75 45	3 5,5 5,5	4 7,5 7,5	5,5 11 11	7,5 15 15	11 18,5 18,5	37 55 37
18,5 30 30	18,5 30 22	23 40 37	22 37 30	30 45 37	30 55 37	37 75 45	37 90 45	55 110 45	3,7 7,5 7,5	5,5 11 11	7,5 15 15	11 22 22	15 30 50	75 132 37
80 1200	80 1600	100 1600	100 1850	125 2500	160 3000	200 4000	250 4600	315 5800	25 140	35 280	35 480	63 800	80 1000	315 4200
35 2 –	35(50) ⁴ 2(1/0) –	35 2 –	35(50) ⁴ 2(1/0) –	95 3/0 –	95 3/0 –	185 – 350	185 – 350	185 – 350	2,5 12 –	4 10 –	6 8 –	10 8 –	16 6 –	185 ⁵ – 350
25 4 – – –	25(35) ⁴ 3(2) – – –	25 4 – – –	25(35) ⁴ 3(2) – – –	70 1/0 – – –	70 1/0 – – –	120 – 250 – –	120 – 250 – –	120 – 250 – –	2,5 14 – – –	2,5 12 – – –	4 10 – – –	6 8 – – –	10 6 – – –	150 ⁵ – 300 M12 –
440 4	690 6	440 4	690 6	690 6	690 6	690 6	690 6	690 6	– –	– –	– –	– –	– –	690 6
10 10	16 16	10 10	16 16	16 16	16 16	16 16	16 16	16 16	– –	– –	– –	– –	– –	16 16
2,5 1,5	6 3	2,5 1,5	6 3	6 3	6 3	6 3	6 3	6 3	– –	– –	– –	– –	– –	6 4
10	16	10	16	16	16	16	16	16	–	–	–	–	–	16
1,5 14 1,5 16	2,5 12 2,5 14	1,5 14 1,5 16	2,5 12 2,5 14	2,5 12 2,5 14	2,5 12 2,5 14	2,5 12 2,5 14	2,5 12 2,5 14	2,5 12 2,5 14	– – – –	– – – –	– – – –	– – – –	– – – –	4 12 2,5 14

⁶The switches of the KG- and KH-series shown in this catalog are approved by UL and CSA as „disconnect switches for use in motor circuits“. Exception: Switches in enclosure. ⁴Use copper wire only.

Main Switches and Main Switches with Emergency Function 2 and 3 pole, for Four Hole Panel Mounting

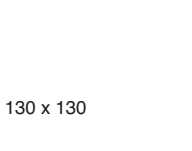

Version	Thermal Current I_U/I_{th}	Ratings AC-23A, AC-23B Breaking Capacity	Main Switches Handle black	EAN-Code 9004257	Main Switches with Emergency Function Handle red Contrasting yellow plate	EAN-Code 9004257	
IP 65 64 x 64 	20 A	220 V/240 V 1,5 kW / 120 A	2 pole KG10B T102/01 E	01367 8	2 pole KG10B T202/01 E	01375 3	
	20 A	3 x 380 V/440 V 5,5 kW / 120 A	3 pole KG10B T103/01 E	01044 8	3 pole KG10B T203/01 E	01049 3	
	25 A	7,5 kW / 180 A	KG20B T103/01 E	00001 2	KG20B T203/01 E	00043 2	
	32 A	11 kW / 220 A	KG32B T103/01 E	00002 9	KG32B T203/01 E	00044 9	
	40 A	15 kW / 300 A	KG41B T103/01 E	00003 6	KG41B T203/01 E	00045 6	
	63 A	22 kW / 350 A	KG64B T103/01 E	00004 3	KG64B T203/01 E	00046 3	
	80 A	30 kW / 560 A	KG80 T103/01 E	00005 0	KG80 T203/01 E	00047 0	
	100 A	37 kW / 650 A	KG100 T103/01 E	00006 7	KG100 T203/01 E	00048 7	
	80 A	30 kW / 560 A	KG80C T103/01 E	01383 8	KG80C T203/01 E	01389 0	
	100 A	37 kW / 650 A	KG100C T103/01 E	01384 5	KG100C T203/01 E	01390 6	
	125 A	45 kW / 750 A	KG125 T103/01 E	00008 1	KG125 T203/01 E	00050 0	
	160 A	55 kW / 850 A	KG160 T103/01 E	00009 8	KG160 T203/01 E	00051 7	
	IP 65 ¹ 48 x 48 	20 A	220 V/240 V 1,5 kW / 120 A	2 pole KG10A T102/04 E	01368 5	2 pole KG10A T202/04 E	01376 0
		20 A	3 x 380 V/440 V 5,5 kW / 120 A	3 pole KG10A T103/04 E	01046 2	3 pole KG10A T203/04 E	01051 6
25 A		7,5 kW / 180 A	KG20A T103/04 E	01110 0	KG20A T203/04 E	01132 2	
32 A		11 kW / 220 A	KG32A T103/04 E	01111 7	KG32A T203/04 E	01133 9	
40 A		15 kW / 300 A	KG41 T103/04 E	01112 4	KG41 T203/04 E	01134 6	
63 A		22 kW / 350 A	KG64 T103/04 E	01113 1	KG64 T203/04 E	01135 3	
20 A		220 V/240 V 1,5 kW / 120 A	2 pole KG10B T102/04 E	01369 2	2 pole KG10B T202/04 E	01377 7	
20 A		3 x 380 V/440 V 5,5 kW / 120 A	3 pole KG10B T103/04 E	01047 9	3 pole KG10B T203/04 E	01052 3	
25 A		7,5 kW / 180 A	KG20B T103/04 E	01114 8	KG20B T203/04 E	01136 0	
32 A		11 kW / 220 A	KG32B T103/04 E	01115 5	KG32B T203/04 E	01137 7	
40 A		15 kW / 300 A	KG41B T103/04 E	01116 2	KG41B T203/04 E	01138 4	
63 A		22 kW / 350 A	KG64B T103/04 E	01117 9	KG64B T203/04 E	01139 1	
80 A		30 kW / 560 A	KG80 T103/04 E	01118 6	KG80 T203/04 E	01140 7	
100 A		37 kW / 650 A	KG100 T103/04 E	01119 3	KG100 T203/04 E	01141 4	
88 x 88 	40 A	15 kW / 300 A	KG41B T103/81 E	03170 2	KG41B T203/81 E	03172 6	
	63 A	22 kW / 350 A	KG64B T103/81 E	03171 9	KG64B T203/81 E	03173 3	
	80 A	30 kW / 560 A	KG80C T103/04 E	00021 0	KG80C T203/04 E	00063 0	
	100 A	37 kW / 650 A	KG100C T103/04 E	00022 7	KG100C T203/04 E	00064 7	
	125 A	45 kW / 750 A	KG125 T103/04 E	00024 1	KG125 T203/04 E	00066 1	
	160 A	55 kW / 850 A	KG160 T103/04 E	00025 8	KG160 T203/04 E	00067 8	
	200 A	75 kW / 1100 A	KG210 T103/05 E	07491 4	KG210 T203/05 E	07484 6	
	250 A	90 kW / 1380 A	KG250 T103/05 E	00027 2	KG250 T203/05 E	00069 2	
	315 A	110 kW / 1650 A	KG315 T103/05 E	00028 9	KG315 T203/05 E	00070 8	
	130 x 130	315 A	132 kW / 2000 A	C316 T103/05 E	00029 6	C316 T203/05 E	00071 5

¹C316 protection IP 40. Higher protection available on request.

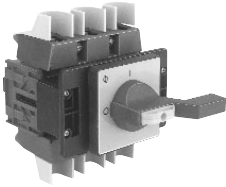

Main Switches and Main Switches with Emergency Function 3 pole, for Four Hole Panel Mounting

Version	Thermal Current I_u/I_{th}	Ratings AC-23A, AC-23B Breaking Capacity 3 x 380 V/440 V	Main Switches Handle black	EAN-Code 9004257	Main Switches with Emergency Function Handle red Contrasting yellow plate	EAN-Code 9004257
IP 65 88 x 88 	250 A 315 A	90 kW / 1380 A 110 kW / 1650 A	KG250 T103/66 E KG315 T103/66 E	01276 3 01277 0	KG250 T203/66 E KG315 T203/66 E	01278 7 01279 4

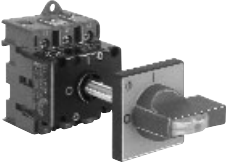

Main Switches and Main Switches with Emergency Function 2 and 3 pole, for Single Hole Mounting 22 mm

Version	Thermal Current I_u/I_{th}	Ratings AC-23A, AC-23B Breaking Capacity	Main Switches Handle black	EAN-Code 9004257	Main Switches with Emergency Function Handle red Contrasting yellow plate	EAN-Code 9004257
IP 65 64 x 64 	20 A 20 A 25 A 32 A	220 V/240 V 1,5 kW / 120 A 3 x 380 V/440 V 5,5 kW / 120 A 7,5 kW / 180 A 11 kW / 220 A	2 pole KG10B T102/01 FT2 3 pole KG10B T103/01 FT2 KG20B T103/01 FT2 KG32B T103/01 FT2	01372 2 01048 6 00085 2 00086 9	2 pole KG10B T202/01 FT2 3 pole KG10B T203/01 FT2 KG20B T203/01 FT2 KG32B T203/01 FT2	01380 7 01053 0 00089 0 00090 6
IP 65 48 x 48 	20 A 20 A 25 A 32 A	220 V/240 V 1,5 kW / 120 A 3 x 380 V/440 V 5,5 kW / 120 A 7,5 kW / 180 A 11 kW / 220 A	2 pole KG10A T102/04 FT2 3 pole KG10A T103/04 FT2 KG20A T103/04 FT2 KG32A T103/04 FT2	01370 8 01054 7 01130 8 01131 5	2 pole KG10A T202/04 FT2 3 pole KG10A T203/04 FT2 KG20A T203/04 FT2 KG32A T203/04 FT2	01378 4 01072 1 01152 0 01153 7
64 x 64	20 A	220 V/240 V 1,5 kW / 120 A	2 pole KG10B T102/04 FT2	01371 5	2 pole KG10B T202/04 FT2	01379 1
	20 A 25 A 32 A	3 x 380 V/440 V 5,5 kW / 120 A 7,5 kW / 180 A 11 kW / 220 A	3 pole KG10B T103/04 FT2 KG20B T103/04 FT2 KG32B T103/04 FT2	01055 4 01056 1 01057 8	3 pole KG10B T203/04 FT2 KG20B T203/04 FT2 KG32B T203/04 FT2	01073 8 01074 5 01075 2

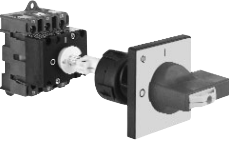
**Main Switches and Main Switches with Emergency Function
2 and 3 pole, for Base Mounting
with Simplified Door Clutch, Padlock Device and Single Hole Mounting 22 mm**

Version	Thermal Current I_U/I_{th}	Ratings AC-23A, AC-23B Breaking Capacity	Main Switches	EAN-Code	Main Switches with Emergency Function	EAN-Code	
Protection Escutcheon plate in mm			Handle black	9004257	Handle red Contrasting yellow plate	9004257	
IP 65 48 x 48 	20 A	220 V/240 V 1,5 kW / 120 A	2 pole KG10A T102/68 VE	01373 9	2 pole KG10A T202/68 VE	01381 4	
	20 A	3 x 380 V/440 V 5,5 kW / 120 A	3 pole KG10A T103/68 VE	01060 8	3 pole KG10A T203/68 VE	01078 3	
	25 A	7,5 kW / 180 A	KG20A T103/68 VE	01061 5	KG20A T203/68 VE	01079 0	
	32 A	11 kW / 220 A	KG32A T103/68 VE	01062 2	KG32A T203/68 VE	01080 6	
	40 A	15 kW / 300 A	KG41 T103/68 VE	01063 9	KG41 T203/68 VE	01081 3	
	63 A	22 kW / 350 A	KG64 T103/68 VE	01064 6	KG64 T203/68 VE	01082 0	
	64 x 64	20 A	220 V/240 V 1,5 kW / 120 A	2 pole KG10B T102/68 VE	01374 6	2 pole KG10B T202/68 VE	01382 1
		20 A	3 x 380 V/440 V 5,5 kW / 120 A	3 pole KG10B T103/68 VE	01065 3	3 pole KG10B T203/68 VE	01083 7
		25 A	7,5 kW / 180 A	KG20B T103/68 VE	01066 0	KG20B T203/68 VE	01084 4
		32 A	11 kW / 220 A	KG32B T103/68 VE	01067 7	KG32B T203/68 VE	01085 1
		40 A	15 kW / 300 A	KG41B T103/68 VE	01068 4	KG41B T203/68 VE	01086 8
		63 A	22 kW / 350 A	KG64B T103/68 VE	01069 1	KG64B T203/68 VE	01087 5
		80 A	30 kW / 560 A	KG80 T103/68 VE	01070 7	KG80 T203/68 VE	01088 2
		100 A	37 kW / 650 A	KG100 T103/68 VE	01071 4	KG100 T203/68 VE	01089 9
IP 65 64 x 64  <p>Misalignment between the shaft and operator is compensated for by a centering device.</p>	20 A	3 x 380 V/440 V 5,5 kW / 120 A	3 pole KG10B T103/93 VE	06347 5	3 pole KG10B T203/93 VE	06354 3	
	25 A	7,5 kW / 180 A	KG20B T103/93 VE	06348 2	KG20B T203/93 VE	06355 0	
	32 A	11 kW / 220 A	KG32B T103/93 VE	06349 9	KG32B T203/93 VE	06356 7	
	40 A	15 kW / 300 A	KG41B T103/93 VE	06350 5	KG41B T203/93 VE	06357 4	
	63 A	22 kW / 350 A	KG64B T103/93 VE	06351 2	KG64B T203/93 VE	06358 1	
	80 A	30 kW / 560 A	KG80 T103/93 VE	06352 9	KG80 T203/93 VE	06359 8	
	100 A	37 kW / 650 A	KG100 T103/93 VE	06353 6	KG100 T203/93 VE	06360 4	
	IP 65 64 x 64  <p>Misalignment between the shaft and operator is compensated for by a centering device.</p>	20 A	3 x 380 V/440 V 5,5 kW / 120 A	3 pole KG10B T103/94 VE	06361 1	3 pole KG10B T203/94 VE	06368 0
25 A		7,5 kW / 180 A	KG20B T103/94 VE	06362 8	KG20B T203/94 VE	06369 7	
32 A		11 kW / 220 A	KG32B T103/94 VE	06363 5	KG32B T203/94 VE	06370 3	
40 A		15 kW / 300 A	KG41B T103/94 VE	06364 2	KG41B T203/94 VE	06371 0	
63 A		22 kW / 350 A	KG64B T103/94 VE	06365 9	KG64B T203/94 VE	06372 7	
80 A		30 kW / 560 A	KG80 T103/94 VE	06366 6	KG80 T203/94 VE	06373 4	
100 A		37 kW / 650 A	KG100 T103/94 VE	06367 3	KG100 T203/94 VE	06374 1	

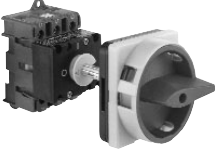
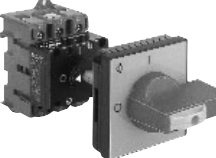
Main Switches and Main Switches with Emergency Function 3 pole, for Base Mounting with Door Clutch

Version	Thermal Current I_u/I_{th}	Ratings AC-23A, AC-23B Breaking Capacity 3 x 380 V/440 V	Main Switches Handle black	EAN-Code 9004257	Main Switches with Emergency Function Handle red Contrasting yellow plate	EAN-Code 9004257
IP 40 ¹ 64 x 64 	20 A 25 A 32 A 40 A 63 A 80 A 100 A	5,5 kW / 120 A 7,5 kW / 180 A 11 kW / 220 A 15 kW / 300 A 22 kW / 350 A 30 kW / 560 A 37 kW / 650 A	KG10B T103/09 VE KG20B T103/09 VE KG32B T103/09 VE KG41B T103/09 VE KG64B T103/09 VE KG80 T103/09 VE KG100 T103/09 VE	01280 0 00093 7 00094 4 00095 1 00096 8 00097 5 00098 2	KG10B T203/09 VE KG20B T203/09 VE KG32B T203/09 VE KG41B T203/09 VE KG64B T203/09 VE KG80 T203/09 VE KG100 T203/09 VE	01281 7 00107 1 00108 8 00109 5 00110 1 00111 8 00112 5
88 x 88	125 A 160 A	45 kW / 750 A 55 kW / 850 A	KG125 T103/09 VE KG160 T103/09 VE	00100 2 00101 9	KG125 T203/09 VE KG160 T203/09 VE	00114 9 00115 6
IP 65 48 x 48 	20 A 25 A 32 A	5,5 kW / 120 A 7,5 kW / 180 A 11 kW / 220 A	KG10A T103/65 VE KG20A T103/65 VE KG32A T103/65 VE	01058 5 01120 9 01121 6	KG10A T203/65 VE KG20A T203/65 VE KG32A T203/65 VE	01076 9 01142 1 01143 8
64 x 64	20 A 25 A 32 A 40 A 63 A 80 A 100 A	5,5 kW / 120 A 7,5 kW / 180 A 11 kW / 220 A 15 kW / 300 A 22 kW / 350 A 30 kW / 560 A 37 kW / 650 A	KG10B T103/65 VE KG20B T103/65 VE KG32B T103/65 VE KG41B T103/65 VE KG64B T103/65 VE KG80 T103/65 VE KG100 T103/65 VE	01059 2 01124 7 01125 4 01126 1 01127 8 01128 5 01129 2	KG10B T203/65 VE KG20B T203/65 VE KG32B T203/65 VE KG41B T203/65 VE KG64B T203/65 VE KG80 T203/65 VE KG100 T203/65 VE	01077 6 01146 9 01147 6 01148 3 01149 0 01150 6 01151 3
IP 65 88 x 88  With integrated door clutch. The handle is restricted if the door is opened. In the I-position the door can be opened with a special key. Possible misalignment of the shaft can be compensated for by the door clutch. To open the door in the I-position an unlock insert S1D M700 29 is available on request. See page 33.	25 A 32 A 40 A 63 A 80 A 100 A 125 A 160 A 200 A 250 A 315 A 315 A	7,5 kW / 180 A 11 kW / 220 A 15 kW / 300 A 22 kW / 350 A 30 kW / 560 A 37 kW / 650 A 45 kW / 750 A 55 kW / 850 A 75 kW / 1100 A 90 kW / 1380 A 110 kW / 1650 A 132 kW / 2000 A	KG20B T103/12 VE KG32B T103/12 VE KG41B T103/12 VE KG64B T103/12 VE KG80 T103/12 VE KG100 T103/12 VE KG125 T103/12 VE KG160 T103/12 VE KG210 T103/13 VE KG250 T103/13 VE KG315 T103/13 VE C316 T103/13 VE	01591 7 01592 4 00129 3 00130 9 00131 6 00132 3 00134 7 00135 4 07492 1 00137 8 00138 5 00139 2	KG20B T203/12 VE KG32B T203/12 VE KG41B T203/12 VE KG64B T203/12 VE KG80 T203/12 VE KG100 T203/12 VE KG125 T203/12 VE KG160 T203/12 VE KG210 T203/13 VE KG250 T203/13 VE KG315 T203/13 VE C316 T203/13 VE	01593 1 01594 8 00159 0 00160 6 00161 3 00162 0 00164 4 00165 1 07485 3 00167 5 00168 2 00169 9

¹Higher protection available on request.

Main Switches and Main Switches with Emergency Function 4 pole, for Four Hole Panel Mounting

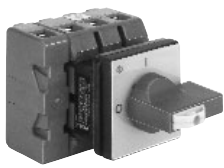
Version	Thermal Current I_U/I_{th}	Ratings AC-23A, AC-23B Breaking Capacity 3 x 380 V/440 V	Main Switches Handle black	EAN-Code 9004257	Main Switches with Emergency Function Handle red Contrasting yellow plate	EAN-Code 9004257	
IP 65 64 x 64 	16 A	7,5 kW / 160 A	KH16B T104/01 E	07091 6	KH16B T204/01 E	07094 7	
	20 A	10 kW / 200 A	KH20B T104/01 E	07092 3	KH20B T204/01 E	07095 4	
	25 A	12 kW / 250 A	KH25B T104/01 E	07093 0	KH25B T204/01 E	07096 1	
	32 A	16 kW / 300 A	KH32 T104/01 E	06510 3	KH32 T204/01 E	06511 0	
	40 A	20 kW / 380 A	KH40 T104/01 E	06512 7	KH40 T204/01 E	06513 4	
	63 A	30 kW / 500 A	KH63 T104/01 E	07493 8	KH63 T204/01 E	07486 0	
	80 A	40 kW / 630 A	KH80 T104/01 E	07494 5	KH80 T204/01 E	07487 7	
	100 A	37 kW / 650 A	KG100 T104/01 E	00186 6	KG100 T204/01 E	00228 3	
	88 x 88	80 A	30 kW / 560 A	KG80C T104/01 E	01385 2	KG80C T204/01 E	01391 3
		100 A	37 kW / 650 A	KG100C T104/01 E	01386 9	KG100C T204/01 E	01392 0
125 A		45 kW / 750 A	KG125 T104/01 E	00188 0	KG125 T204/01 E	00230 6	
160 A		55 kW / 850 A	KG160 T104/01 E	00189 7	KG160 T204/01 E	00231 3	
IP 65 ¹ 48 x 48 		16 A	7,5 kW / 160 A	KH16 T104/04 E	07097 8	KH16 T204/04 E	07098 5
	20 A	10 kW / 200 A	KH20 T104/04 E	07099 2	KH20 T204/04 E	07100 5	
	25 A	12 kW / 250 A	KH25 T104/04 E	07101 2	KH25 T204/04 E	07102 9	
	32 A	11 kW / 220 A	KG32A T104/04 E	01236 7	KG32A T204/04 E	01248 0	
	40 A	15 kW / 300 A	KG41 T104/04 E	01238 1	KG41 T204/04 E	01250 3	
	63 A	22 kW / 350 A	KG64 T104/04 E	01240 4	KG64 T204/04 E	01252 7	
	64 x 64	16 A	7,5 kW / 160 A	KH16B T104/04 E	07103 6	KH16B T204/04 E	07106 7
		20 A	10 kW / 200 A	KH20B T104/04 E	07104 3	KH20B T204/04 E	07107 4
		25 A	12 kW / 250 A	KH25B T104/04 E	07105 0	KH25B T204/04 E	07108 1
		32 A	16 kW / 300 A	KH32 T104/04 E	06514 1	KH32 T204/04 E	06515 8
40 A		20 kW / 380 A	KH40 T104/04 E	06516 5	KH40 T204/04 E	06517 2	
63 A		30 kW / 500 A	KH63 T104/04 E	07495 2	KH63 T204/04 E	07488 4	
80 A		40 kW / 630 A	KH80 T104/04 E	07496 9	KH80 T204/04 E	07489 1	
100 A		37 kW / 650 A	KG100 T104/04 E	01243 5	KG100 T204/04 E	01255 8	
88 x 88		80 A	30 kW / 560 A	KG80C T104/04 E	00201 6	KG80C T204/04 E	00243 6
		100 A	37 kW / 650 A	KG100C T104/04 E	00202 3	KG100C T204/04 E	00244 3
	125 A	45 kW / 750 A	KG125 T104/04 E	00204 7	KG125 T204/04 E	00246 7	
	160 A	55 kW / 850 A	KG160 T104/04 E	00205 4	KG160 T204/04 E	00247 4	
	200 A	75 kW / 1100 A	KG210 T104/05 E	07497 6	KG210 T204/05 E	07490 7	
	250 A	90 kW / 1380 A	KG250 T104/05 E	00207 8	KG250 T204/05 E	00249 8	
	315 A	110 kW / 1650 A	KG315 T104/05 E	00208 5	KG315 T204/05 E	00250 4	
	130 x 130	315 A	132 kW / 2000 A	C316 T104/05 E	00209 2	C316 T204/05 E	00251 1

¹C316 protection IP 40. Higher protection available on request.

Main Switches and Main Switches with Emergency Function 4 pole, for Four Hole Panel Mounting

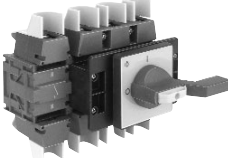

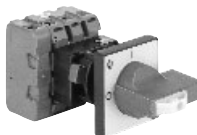

Version	Thermal Current I_u/I_{th}	Ratings AC-23A, AC-23B Breaking Capacity 3 x 380 V/440 V	Main Switches	EAN-Code 9004257	Main Switches with Emergency Function	EAN-Code 9004257
Protection Escutcheon plate in mm			Handle black		Handle red Contrasting yellow plate	
IP 65 88 x 88	250 A 315 A	90 kW / 1380 A 110 kW/ 1650 A	KG250 T104/66 E KG315 T104/66 E	01256 5 01257 2	KG250 T204/66 E KG315 T204/66 E	01258 9 01259 6
						

Main Switches and Main Switches with Emergency Function 4 pole, for Single Hole Mounting 22 mm

Version	Thermal Current I_u/I_{th}	Ratings AC-23A, AC-23B Breaking Capacity 3 x 380 V/440 V	Main Switches	EAN-Code 9004257	Main Switches with Emergency Function	EAN-Code 9004257
Protection Escutcheon plate in mm			Handle black		Handle red Contrasting yellow plate	
IP 65 64 x 64	16 A 20 A 25 A 32 A 40 A 63 A 80 A	7,5 kW / 160 A 10 kW / 200 A 12 kW / 250 A 16 kW / 300 A 20 kW / 380 A 30 kW / 500 A 40 kW / 630 A	KH16 T104/01 FH3 KH20 T104/01 FH3 KH25 T104/01 FH3 KH32 T104/01 FH3 KH40 T104/01 FH3 KH63 T104/01 FH3 ¹ KH80 T104/01 FH3 ¹	07109 8 07110 4 07111 1 06668 1 06669 8 08908 6 08910 9	KH16 T204/01 FH3 KH20 T204/01 FH3 KH25 T204/01 FH3 KH32 T204/01 FH3 KH40 T204/01 FH3 KH63 T204/01 FH3 ¹ KH80 T204/01 FH3 ¹	07112 8 07113 5 07114 2 06670 4 06671 1 08909 3 08911 6
IP 65 48 x 48	16 A 20 A 25 A 32 A	7,5 kW / 160 A 10 kW / 200 A 12 kW / 250 A 11 kW / 220 A	KH16 T104/04 FT2 KH20 T104/04 FT2 KH25 T104/04 FT2 KG32A T104/04 FT2	07115 9 07116 6 07117 3 01266 4	KH16 T204/04 FT2 KH20 T204/04 FT2 KH25 T204/04 FT2 KG32A T204/04 FT2	07118 0 07119 7 07120 3 01272 5
64 x 64	16 A 20 A 25 A 32 A 40 A 63 A 80 A	7,5 kW / 160 A 10 kW / 200 A 12 kW / 250 A 16 kW / 300 A 20 kW / 380 A 30 kW / 500 A 40 kW / 630 A	KH16 T104/04 FH3 KH20 T104/04 FH3 KH25 T104/04 FH3 KH32 T104/04 FH3 KH40 T104/04 FH3 KH63 T104/04 FH3 ¹ KH80 T104/04 FH3 ¹	07121 0 07122 7 07123 4 06672 8 06673 5 08912 3 08914 7	KH16 T204/04 FH3 KH20 T204/04 FH3 KH25 T204/04 FH3 KH32 T204/04 FH3 KH40 T204/04 FH3 KH63 T204/04 FH3 ¹ KH80 T204/04 FH3 ¹	07124 1 07125 8 07126 5 06674 2 06675 9 08913 0 08915 4
						
						

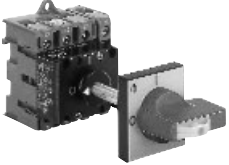
¹For KH63 and KH80 use flexible wire only in order to avoid excessive pressure on single hole mounting.

**Main Switches and Main Switches with Emergency Function
4 pole, for Base Mounting
with Door Clutch, Padlock Device and Single Hole Mounting 22 mm**

Version	Thermal Current I_U/I_{th}	Ratings AC-23A, AC-23B Breaking Capacity 3 x 380 V/440 V	Main Switches Handle black	EAN-Code 9004257	Main Switches with Emergency Function Handle red Contrasting yellow plate	EAN-Code 9004257
IP 65 48 x 48 	16 A 20 A 25 A 32 A 40 A 63 A	7,5 kW / 160 A 10 kW / 200 A 12 kW / 250 A 11 kW / 220 A 15 kW / 300 A 22 kW / 350 A	KH16 T104/68 VE KH20 T104/68 VE KH25 T104/68 VE KG32A T104/68 VE KG41 T104/68 VE KG64 T104/68 VE	07127 2 07128 9 07129 6 01182 7 01184 1 01186 5	KH16 T204/68 VE KH20 T204/68 VE KH25 T204/68 VE KG32A T204/68 VE KG41 T204/68 VE KG64 T204/68 VE	07130 2 07131 9 07132 6 01194 0 01196 4 01198 8
64 x 64 	16 A 20 A 25 A 32 A 40 A 63 A 80 A 100 A	7,5 kW / 160 A 10 kW / 200 A 12 kW / 250 A 16 kW / 300 A 20 kW / 380 A 30 kW / 500 A 40 kW / 630 A 37 kW / 650 A	KH16B T104/68 VE KH20B T104/68 VE KH25B T104/68 VE KH32 T104/68 VE KH40 T104/68 VE KH63 T104/68 VE KH80 T104/68 VE KG100 T104/68 VE	07133 3 07134 0 07135 7 06518 9 06520 2 07498 3 07500 3 01189 6	KH16B T204/68 VE KH20B T204/68 VE KH25B T204/68 VE KH32 T204/68 VE KH40 T204/68 VE KH63 T204/68 VE KH80 T204/68 VE KG100 T204/68 VE	07136 4 07137 1 07138 8 06519 6 06521 9 07499 0 07501 0 01201 5
IP 65 64 x 64  <p>Misalignment between the shaft and operator is compensated for by a centering device.</p>	16 A 20 A 25 A 32 A 40 A 63 A 80 A 100 A	7,5 kW / 160 A 10 kW / 200 A 12 kW / 250 A 16 kW / 300 A 20 kW / 380 A 30 kW / 500 A 40 kW / 630 A 37 kW / 650 A	KH16B T104/93 VE KH20B T104/93 VE KH25B T104/93 VE KH32 T104/93 VE KH40 T104/93 VE KH63 T104/93 VE KH80 T104/93 VE KG100 T104/93 VE	07139 5 07140 1 07141 8 06522 6 06524 0 07502 7 07504 1 06381 9	KH16B T204/93 VE KH20B T204/93 VE KH25B T204/93 VE KH32 T204/93 VE KH40 T204/93 VE KH63 T204/93 VE KH80 T204/93 VE KG100 T204/93 VE	07142 5 07143 2 07144 9 06523 3 06525 7 07503 4 07505 8 06388 8
IP 65 64 x 64  <p>Misalignment between the shaft and operator is compensated for by a centering device.</p>	16 A 20 A 25 A 32 A 40 A 63 A 80 A 100 A	7,5 kW / 160 A 10 kW / 200 A 12 kW / 250 A 16 kW / 300 A 20 kW / 380 A 30 kW / 500 A 40 kW / 630 A 37 kW / 650 A	KH16B T104/94 VE KH20B T104/94 VE KH25B T104/94 VE KH32 T104/94 VE KH40 T104/94 VE KH63 T104/94 VE KH80 T104/94 VE KG100 T104/94 VE	07145 6 07146 3 07147 0 06526 4 06528 8 07506 5 07508 9 06395 6	KH16B T204/94 VE KH20B T204/94 VE KH25B T204/94 VE KH32 T204/94 VE KH40 T204/94 VE KH63 T204/94 VE KH80 T204/94 VE KG100 T204/94 VE	07148 7 07149 4 07150 0 06527 1 06529 5 07507 2 07509 6 06402 1

Main Switches and Main Switches with Emergency Function 4 pole, for Base Mounting with Door Clutch

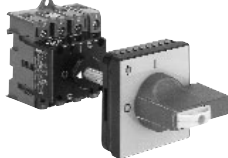
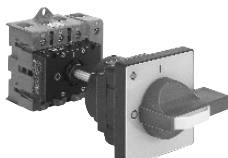
Version	Thermal Current I_u/I_{th}	Ratings AC-23A, AC-23B Breaking Capacity 3 x 380 V/440 V	Main Switches		EAN-Code 9004257	Main Switches with Emergency Function		EAN-Code 9004257	
Protection Escutcheon plate in mm			Handle black			Handle red Contrasting yellow plate			
IP 40 ¹ 64 x 64 	16 A	7,5 kW / 160 A	KH16B	T104/09 VE	07151 7	KH16B	T204/09 VE	07154 8	
	20 A	10 kW / 200 A	KH20B	T104/09 VE	07152 4	KH20B	T204/09 VE	07155 5	
	25 A	12 kW / 250 A	KH25B	T104/09 VE	07153 1	KH25B	T204/09 VE	07156 2	
	32 A	16 kW / 300 A	KH32	T104/09 VE	06530 1	KH32	T204/09 VE	06531 8	
	40 A	20 kW / 380 A	KH40	T104/09 VE	06532 5	KH40	T204/09 VE	06533 2	
	63 A	30 kW / 500 A	KH63	T104/09 VE	07510 2	KH63	T204/09 VE	07511 9	
	80 A	40 kW / 630 A	KH80	T104/09 VE	07512 6	KH80	T204/09 VE	07513 3	
	100 A	37 kW / 650 A	KG100	T104/09 VE	00278 8	KG100	T204/09 VE	00292 4	
	88 x 88	125 A	45 kW / 750 A	KG125	T104/09 VE	00280 1	KG125	T204/09 VE	00294 8
		160 A	55 kW / 850 A	KG160	T104/09 VE	00281 8	KG160	T204/09 VE	00295 5
	IP 65 48 x 48 64 x 64 	16 A	7,5 kW / 160 A	KH16	T104/65 VE	07157 9	KH16	T204/65 VE	07160 9
		20 A	10 kW / 200 A	KH20	T104/65 VE	07158 6	KH20	T204/65 VE	07161 6
		25 A	12 kW / 250 A	KH25	T104/65 VE	07159 3	KH25	T204/65 VE	07162 3
		64 x 64	16 A	7,5 kW / 160 A	KH16B	T104/65 VE	07163 0	KH16B	T204/65 VE
20 A			10 kW / 200 A	KH20B	T104/65 VE	07164 7	KH20B	T204/65 VE	07167 8
25 A			12 kW / 250 A	KH25B	T104/65 VE	07165 4	KH25B	T204/65 VE	07168 5
32 A			16 kW / 300 A	KH32	T104/65 VE	06534 9	KH32	T204/65 VE	06535 6
40 A			20 kW / 380 A	KH40	T104/65 VE	06536 3	KH40	T204/65 VE	06537 0
63 A			30 kW / 500 A	KH63	T104/65 VE	07514 0	KH63	T204/65 VE	07515 7
80 A			40 kW / 630 A	KH80	T104/65 VE	07516 4	KH80	T204/65 VE	07517 1
88 x 88		100 A	37 kW / 650 A	KG100	T104/65 VE	01165 0	KG100	T204/65 VE	01177 3
		125 A	45 kW / 750 A	KG125	T104/65 VE	03174 0	KG125	T204/65 VE	03178 8
		160 A	55 kW / 850 A	KG160	T104/65 VE	03175 7	KG160	T204/65 VE	03179 5
		250 A	90 kW / 1380 A	KG250	T104/83 VE	03198 6	KG250	T204/83 VE	03200 6
	315 A	110 kW / 1650 A	KG315	T104/83 VE	03199 3	KG315	T204/83 VE	03201 3	
IP 65 88 x 88 	25 A	7,5 kW / 180 A	KG20B	T104/12 VE	00307 5	KG20B	T204/12 VE	00337 2	
	32 A	16 kW / 300 A	KH32	T104/12 VE	06538 7	KH32	T204/12 VE	06539 4	
	40 A	20 kW / 380 A	KH40	T104/12 VE	06540 0	KH40	T204/12 VE	06541 7	
	63 A	30 kW / 500 A	KH63	T104/12 VE	07518 8	KH63	T204/12 VE	07519 5	
	80 A	40 kW / 630 A	KH80	T104/12 VE	07520 1	KH80	T204/12 VE	07521 8	
	100 A	37 kW / 650 A	KG100	T104/12 VE	00312 9	KG100	T204/12 VE	00342 6	
	125 A	45 kW / 750 A	KG125	T104/12 VE	00314 3	KG125	T204/12 VE	00344 0	
	160 A	55 kW / 850 A	KG160	T104/12 VE	00315 0	KG160	T204/12 VE	00345 7	
	200 A	75 kW / 1100 A	KG210	T104/13 VE	07522 5	KG210	T204/13 VE	07523 2	
	250 A	90 kW / 1380 A	KG250	T104/13 VE	00317 4	KG250	T204/13 VE	00347 1	
	315 A	110 kW / 1650 A	KG315	T104/13 VE	00318 1	KG315	T204/13 VE	00348 8	
	315 A	132 kW / 2000 A	C316	T104/13 VE	00319 8	C316	T204/13 VE	00349 5	

With integrated door clutch. The handle is restricted if the door is opened. In the I-position the door can be opened with a special key. Possible misalignment of the shaft can be compensated for by the door clutch. To open the door in the I-position an unlock insert S1D M700 29 is available on request. See page 33.

¹Higher protection available on request.

Main Switches and Main Switches with Emergency Function
3 pole + Ground and Neutral Terminal,
for Four Hole Panel Mounting

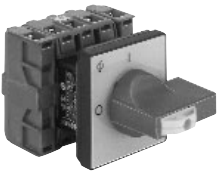
Version	Thermal Current I_U/I_{th}	Ratings AC-23A, AC-23B Breaking Capacity 3 x 380 V/440 V	Main Switches Handle black	EAN-Code 9004257	Main Switches with Emergency Function Handle red Contrasting yellow plate	EAN-Code 9004257
IP 65 64 x 64 	20 A	5,5 kW / 120 A	KG10B T105/01 E ²	01395 1	KG10B T205/01 E ²	01406 4
	25 A	7,5 kW / 180 A	KG20B T105/01 E	01396 8	KG20B T205/01 E	01407 1
	32 A	11 kW / 220 A	KG32B T105/01 E	01397 5	KG32B T205/01 E	01408 8
	40 A	15 kW / 300 A	KG41B T105/01 E	01398 2	KG41B T205/01 E	01409 5
	63 A	22 kW / 350 A	KG64B T105/01 E	01399 9	KG64B T205/01 E	01410 1
	80 A	30 kW / 560 A	KG80 T105/01 E	01400 2	KG80 T205/01 E	01411 8
	100 A	37 kW / 650 A	KG100 T105/01 E	01402 6	KG100 T205/01 E	01413 2
88 x 88	80 A	30 kW / 560 A	KG80C T105/01 E	01401 9	KG80C T205/01 E	01412 5
	100 A	37 kW / 650 A	KG100C T105/01 E	01403 3	KG100C T205/01 E	01414 9
	125 A	45 kW / 750 A	KG125 T105/01 E	01404 0	KG125 T205/01 E	01415 6
	160 A	55 kW / 850 A	KG160 T105/01 E	01405 7	KG160 T205/01 E	01416 3
IP 65 ¹ 48 x 48	20 A	5,5 kW / 120 A	KG10A T105/04 E ²	01417 0	KG10A T205/04 E ²	01433 0
	25 A	7,5 kW / 180 A	KG20A T105/04 E	01418 7	KG20A T205/04 E	01434 7
	32 A	11 kW / 220 A	KG32A T105/04 E	01419 4	KG32A T205/04 E	01435 4
	40 A	15 kW / 300 A	KG41 T105/04 E	01420 0	KG41 T205/04 E	01436 1
	63 A	22 kW / 350 A	KG64 T105/04 E	01421 7	KG64 T205/04 E	01437 8
64 x 64 	20 A	5,5 kW / 120 A	KG10B T105/04 E ²	01422 4	KG10B T205/04 E ²	01438 5
	25 A	7,5 kW / 180 A	KG20B T105/04 E	01423 1	KG20B T205/04 E	01439 2
	32 A	11 kW / 220 A	KG32B T105/04 E	01424 8	KG32B T205/04 E	01440 8
	40 A	15 kW / 300 A	KG41B T105/04 E	01425 5	KG41B T205/04 E	01441 5
	63 A	22 kW / 350 A	KG64B T105/04 E	01426 2	KG64B T205/04 E	01442 2
	80 A	30 kW / 560 A	KG80 T105/04 E	01427 9	KG80 T205/04 E	01443 9
	100 A	37 kW / 650 A	KG100 T105/04 E	01428 6	KG100 T205/04 E	01444 6
88 x 88	80 A	30 kW / 560 A	KG80C T105/04 E	01429 3	KG80C T205/04 E	01445 3
	100 A	37 kW / 650 A	KG100C T105/04 E	01430 9	KG100C T205/04 E	01446 0
	125 A	45 kW / 750 A	KG125 T105/04 E	01431 6	KG125 T205/04 E	01447 7
	160 A	55 kW / 850 A	KG160 T105/04 E	01432 3	KG160 T205/04 E	01448 4
	200 A	75 kW / 1100 A	KG210 T105/05 E	07524 9	KG210 T205/05 E	07525 6
	250 A	90 kW / 1380 A	KG250 T105/05 E	01449 1	KG250 T205/05 E	01451 4
	315 A	110 kW / 1650 A	KG315 T105/05 E	01450 7	KG315 T205/05 E	01452 1

¹C316 protection IP 40. Higher protection available on request. ²In preparation.

Main Switches and Main Switches with Emergency Function 3 pole + Ground and Neutral Terminal, for Four Hole Panel Mounting

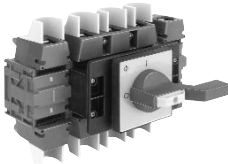

Version	Thermal Current I_u/I_{th}	Ratings AC-23A, AC-23B Breaking Capacity 3 x 380 V/440 V	Main Switches Handle black	EAN-Code 9004257	Main Switches with Emergency Function Handle red Contrasting yellow plate	EAN-Code 9004257
IP 65 88 x 88 	250 A 315 A	90 kW / 1380 A 110 kW / 1650 A	KG250 T105/66 E KG315 T105/66 E	01584 9 01585 6	KG250 T205/66 E KG315 T205/66 E	01586 3 01587 0

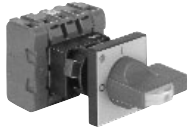
Main Switches and Main Switches with Emergency Function 3 pole + Ground and Neutral Terminal, for Single Hole Mounting 22 mm

Version	Thermal Current I_u/I_{th}	Ratings AC-23A, AC-23B Breaking Capacity 3 x 380 V/440 V	Main Switches Handle black	EAN-Code 9004257	Main Switches with Emergency Function Handle red Contrasting yellow plate	EAN-Code 9004257
IP 65 64 x 64 	20 A 25 A 32 A	5,5 kW / 120 A 7,5 kW / 180 A 11 kW / 220 A	KG10B T105/01 FT2 ¹ KG20B T105/01 FT2 KG32B T105/01 FT2	01453 8 01454 5 01455 2	KG10B T205/01 FT2 ¹ KG20B T205/01 FT2 KG32B T205/01 FT2	01456 9 01457 6 01458 3
IP 65 48 x 48 	20 A 25 A 32 A	5,5 kW / 120 A 7,5 kW / 180 A 11 kW / 220 A	KG10A T105/04 FT2 ¹ KG20A T105/04 FT2 KG32A T105/04 FT2	01459 0 01460 6 01461 3	KG10A T205/04 FT2 ¹ KG20A T205/04 FT2 KG32A T205/04 FT2	01462 0 01463 7 01464 4
64 x 64	20 A 25 A 32 A	5,5 kW / 120 A 7,5 kW / 180 A 11 kW / 220 A	KG10B T105/04 FT2 ¹ KG20B T105/04 FT2 KG32B T105/04 FT2	01599 3 01601 3 01603 7	KG10B T205/04 FT2 ¹ KG20B T205/04 FT2 KG32B T205/04 FT2	01600 6 01602 0 01604 4

¹In preparation.

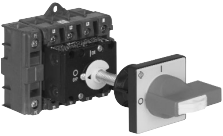
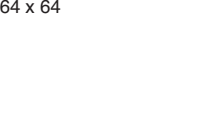
Main Switches and Main Switches with Emergency Function
3 pole + Ground and Neutral Terminal, for Base Mounting
with Door Clutch, Padlock Device and Single Hole Mounting 22 mm

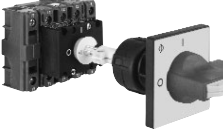
Version	Thermal Current I_U/I_{th}	Ratings AC-23A, AC-23B Breaking Capacity 3 x 380 V/440 V	Main Switches Handle black	EAN-Code 9004257	Main Switches with Emergency Function Handle red Contrasting yellow plate	EAN-Code 9004257
IP 65 48 x 48 	20 A 25 A 32 A 40 A 63 A	5,5 kW / 120 A 7,5 kW / 180 A 11 kW / 220 A 15 kW / 300 A 22 kW / 350 A	KG10A T105/68 VE ¹ KG20A T105/68 VE KG32A T105/68 VE KG41 T105/68 VE KG64 T105/68 VE	01523 8 01524 5 01525 2 01526 9 01527 6	KG10A T205/68 VE ¹ KG20A T205/68 VE KG32A T205/68 VE KG41 T205/68 VE KG64 T205/68 VE	01528 3 01529 0 01530 6 01531 3 01532 0
64 x 64 	20 A 25 A 32 A 40 A 63 A 80 A 100 A	5,5 kW / 120 A 7,5 kW / 180 A 11 kW / 220 A 15 kW / 300 A 22 kW / 350 A 30 kW / 560 A 37 kW / 650 A	KG10B T105/68 VE ¹ KG20B T105/68 VE KG32B T105/68 VE KG41B T105/68 VE KG64B T105/68 VE KG80 T105/68 VE KG100 T105/68 VE	01605 1 01607 5 01609 9 01611 2 01613 6 01615 0 01617 4	KG10B T205/68 VE ¹ KG20B T205/68 VE KG32B T205/68 VE KG41B T205/68 VE KG64B T205/68 VE KG80 T205/68 VE KG100 T205/68 VE	01606 8 01608 2 01610 5 01612 9 01614 3 01616 7 01618 1
IP 65 64 x 64  Misalignment between the shaft and operator is compensated for by a centering device.	25 A 32 A 40 A 63 A 80 A 100 A	7,5 kW / 180 A 11 kW / 220 A 15 kW / 300 A 22 kW / 350 A 30 kW / 560 A 37 kW / 650 A	KG20B T105/93 VE KG32B T105/93 VE KG41B T105/93 VE KG64B T105/93 VE KG80 T105/93 VE KG100 T105/93 VE	06403 8 06404 5 06405 2 06406 9 06407 6 06408 3	KG20B T205/93 VE KG32B T205/93 VE KG41B T205/93 VE KG64B T205/93 VE KG80 T205/93 VE KG100 T205/93 VE	06409 0 06410 6 06411 3 06412 0 06413 7 06414 4
IP 65 64 x 64  Misalignment between the shaft and operator is compensated for by a centering device.	25 A 32 A 40 A 63 A 80 A 100 A	7,5 kW / 180 A 11 kW / 220 A 15 kW / 300 A 22 kW / 350 A 30 kW / 560 A 37 kW / 650 A	KG20B T105/94 VE KG32B T105/94 VE KG41B T105/94 VE KG64B T105/94 VE KG80 T105/94 VE KG100 T105/94 VE	06415 1 06416 8 06417 5 06418 2 06419 9 06420 5	KG20B T205/94 VE KG32B T205/94 VE KG41B T205/94 VE KG64B T205/94 VE KG80 T205/94 VE KG100 T205/94 VE	06421 2 06422 9 06423 6 06424 3 06425 0 06426 7

¹In preparation.

Main Switches and Main Switches with Emergency Function 3 pole + Ground and Neutral Terminal, for Base Mounting with Door Clutch

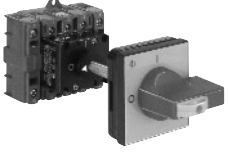
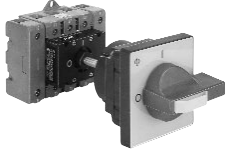
Version	Thermal Current I_u/I_{th}	Ratings AC-23A, AC-23B Breaking Capacity 3 x 380 V/440 V	Main Switches	EAN-Code 9004257	Main Switches with Emergency Function	EAN-Code 9004257	
Protection Escutcheon plate in mm			Handle black		Handle red Contrasting yellow plate		
IP 40 ¹ 64 x 64 	20 A	5,5 kW / 120 A	KG10B T105/09 VE ²	01465 1	KG10B T205/09 VE ²	01474 3	
	25 A	7,5 kW / 180 A	KG20B T105/09 VE	01466 8	KG20B T205/09 VE	01475 0	
	32 A	11 kW / 220 A	KG32B T105/09 VE	01467 5	KG32B T205/09 VE	01476 7	
	40 A	15 kW / 300 A	KG41B T105/09 VE	01468 2	KG41B T205/09 VE	01477 4	
	63 A	22 kW / 350 A	KG64B T105/09 VE	01469 9	KG64B T205/09 VE	01478 1	
	80 A	30 kW / 560 A	KG80 T105/09 VE	01470 5	KG80 T205/09 VE	01479 8	
	100 A	37 kW / 650 A	KG100 T105/09 VE	01471 2	KG100 T205/09 VE	01480 4	
	88 x 88	125 A	45 kW / 750 A	KG125 T105/09 VE	01472 9	KG125 T205/09 VE	01481 1
		160 A	55 kW / 850 A	KG160 T105/09 VE	01473 6	KG160 T205/09 VE	01482 8
	IP 65 48 x 48 	20 A	5,5 kW / 120 A	KG10A T105/65 VE ²	01483 5	KG10A T205/65 VE ²	01495 8
25 A		7,5 kW / 180 A	KG20A T105/65 VE	01485 9	KG20A T205/65 VE	01497 2	
32 A		11 kW / 220 A	KG32A T105/65 VE	01487 3	KG32A T205/65 VE	01499 6	
64 x 64		20 A	5,5 kW / 120 A	KG10B T105/65 VE ²	01484 2	KG10B T205/65 VE ²	01496 5
		25 A	7,5 kW / 180 A	KG20B T105/65 VE	01486 6	KG20B T205/65 VE	01498 9
		32 A	11 kW / 220 A	KG32B T105/65 VE	01488 0	KG32B T205/65 VE	01500 9
		40 A	15 kW / 300 A	KG41B T105/65 VE	01410 3	KG41B T205/65 VE	01502 3
		63 A	22 kW / 350 A	KG64B T105/65 VE	01492 7	KG64B T205/65 VE	01504 7
		80 A	30 kW / 560 A	KG80 T105/65 VE	01493 4	KG80 T205/65 VE	01505 4
		100 A	37 kW / 650 A	KG100 T105/65 VE	01494 1	KG100 T205/65 VE	01506 1
IP 65 88 x 88  With integrated door clutch. The handle is restricted if the door is opened. In the I-position the door can be opened with a special key. Possible misalignment of the shaft can be compensated for by the door clutch. To open the door in the I-position an unlock insert S1D M700 29 is available on request. See page 33.	25 A	7,5 kW / 180 A	KG20B T105/12 VE	01619 8	KG20B T205/12 VE	01620 4	
	32 A	11 kW / 220 A	KG32B T105/12 VE	01621 1	KG32B T205/12 VE	01622 8	
	40 A	15 kW / 300 A	KG41B T105/12 VE	01507 8	KG41B T205/12 VE	01515 3	
	63 A	22 kW / 350 A	KG64B T105/12 VE	01508 5	KG64B T205/12 VE	01516 0	
	80 A	30 kW / 560 A	KG80 T105/12 VE	01509 2	KG80 T205/12 VE	01517 7	
	100 A	37 kW / 650 A	KG100 T105/12 VE	01510 8	KG100 T205/12 VE	01518 4	
	125 A	45 kW / 750 A	KG125 T105/12 VE	01511 5	KG125 T205/12 VE	01519 1	
	160 A	55 kW / 850 A	KG160 T105/12 VE	01512 2	KG160 T205/12 VE	01520 7	
	200 A	75 kW / 1100 A	KG210 T105/13 VE	07526 3	KG210 T205/13 VE	07527 0	
	250 A	90 kW / 1380 A	KG250 T105/13 VE	01513 9	KG250 T205/13 VE	01521 4	
315 A	110 kW / 1650 A	KG315 T105/13 VE	01514 6	KG315 T205/13 VE	01522 1		

¹Higher protection available on request. ²In preparation.

Main Switches and Main Switches with Emergency Function
3 pole + 1 cam- or rack-operated auxiliary contact (NO),
for Four Hole Panel Mounting

Auxiliary contacts with special contact systems allow for use in low voltage and current applications as well as aggressive environments.

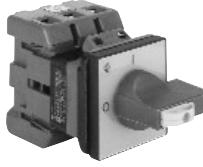
Version	Thermal Current I_U/I_{th}	Ratings AC-23A, AC-23B Breaking Capacity 3 x 380 V/440 V	Main Switches Handle black	EAN-Code 9004257	Main Switches with Emergency Function Handle red Contrasting yellow plate	EAN-Code 9004257
IP 65 64 x 64 	20 A 25 A 32 A 40 A 63 A 80 A 100 A	5,5 kW / 120 A 7,5 kW / 180 A 11 kW / 220 A 15 kW / 300 A 22 kW / 350 A 30 kW / 560 A 37 kW / 650 A	KG10B T103/17 E KG20B T103/17 E KG32B T103/17 E KG41B T103/17 E KG64B T103/17 E KG80 T103/17 E KG100 T103/17 E	01045 5 00361 7 00362 4 00363 1 00364 8 00365 5 00366 2	KG10B T203/17 E KG20B T203/17 E KG32B T203/17 E KG41B T203/17 E KG64B T203/17 E KG80 T203/17 E KG100 T203/17 E	01050 9 00401 0 00402 7 00403 4 00404 1 00405 8 00406 5
88 x 88	80 A 100 A 125 A 160 A	30 kW / 560 A 37 kW / 650 A 45 kW / 750 A 55 kW / 850 A	KG80C T103/17 E KG100C T103/17 E KG125 T103/17 E KG160 T103/17 E	01387 6 01388 3 00368 6 00369 3	KG80C T203/17 E KG100C T203/17 E KG125 T203/17 E KG160 T203/17 E	01393 7 01394 4 00408 9 00409 6
IP 65 ¹ 48 x 48 64 x 64 	20 A 25 A 32 A 20 A 25 A 32 A 40 A 63 A 80 A 100 A	5,5 kW / 120 A 7,5 kW / 180 A 11 kW / 220 A 15 kW / 300 A 22 kW / 350 A 30 kW / 560 A 37 kW / 650 A 5,5 kW / 120 A 7,5 kW / 180 A 11 kW / 220 A 15 kW / 300 A 22 kW / 350 A 30 kW / 560 A 37 kW / 650 A	KG10A T103/20 E KG20A T103/20 E KG32A T103/20 E KG10B T103/20 E KG20B T103/20 E KG32B T103/20 E KG41B T103/20 E KG64B T103/20 E KG80 T103/20 E KG100 T103/20 E	01202 2 01204 6 01206 0 01203 9 01205 3 01207 7 01209 1 01211 4 01212 1 01213 8	KG10A T203/20 E KG20A T203/20 E KG32A T203/20 E KG10B T203/20 E KG20B T203/20 E KG32B T203/20 E KG41B T203/20 E KG64B T203/20 E KG80 T203/20 E KG100 T203/20 E	01214 5 01216 9 01218 3 01215 2 01217 6 01219 0 01221 3 01223 7 01224 4 01225 1
88 x 88	80 A 100 A 125 A 160 A 200 A 250 A 315 A	30 kW / 560 A 37 kW / 650 A 45 kW / 750 A 55 kW / 850 A 75 kW / 1100 A 90 kW / 1380 A 110 kW / 1650 A	KG80C T103/20 E KG100C T103/20 E KG125 T103/20 E KG160 T103/20 E KG210 T103/21 E KG250 T103/21 E KG315 T103/21 E	00379 2 00380 8 00382 2 00383 9 07528 7 00385 3 00386 0	KG80C T203/20 E KG100C T203/20 E KG125 T203/20 E KG160 T203/20 E KG210 T203/21 E KG250 T203/21 E KG315 T203/21 E	00419 5 00420 1 00422 5 00423 2 07529 4 00425 6 00426 3
130 x 130	315 A	132 kW/2000 A	C316 T103/21 E	00387 7	C316 T203/21 E	00427 0

¹C316 protection IP 40. Higher protection available on request.

Main Switches and Main Switches with Emergency Function 3 pole + 1 cam- or rack-operated auxiliary contact (NO), for Four Hole Panel Mounting

Auxiliary contacts with special contact systems allow for use in low voltage and current applications as well aggressive environments.

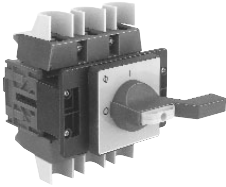
Version Protection Escutcheon plate in mm	Thermal Current I_u/I_{th}	Ratings AC-23A, AC-23B Breaking Capacity 3 x 380 V/440 V	Main Switches Handle black	EAN-Code 9004257	Main Switches with Emergency Function Handle red Contrasting yellow plate	EAN-Code 9004257
IP 65 88 x 88 	250 A 315 A	90 kW / 1380 A 110 kW / 1650 A	KG250 T103/70 E KG315 T103/70 E	01226 8 01227 5	KG250 T203/70 E KG315 T203/70 E	01228 2 01229 9



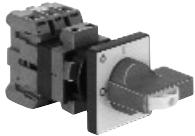

Main Switches and Main Switches with Emergency Function 3 pole + 1 cam-operated auxiliary contact (NO), for Single Hole Mounting 22 mm

Auxiliary contacts with special contact systems allow for use in low voltage and current applications as well aggressive environments.

Version Protection Escutcheon plate in mm	Thermal Current I_u/I_{th}	Ratings AC-23A, AC-23B Breaking Capacity 3 x 380 V/440 V	Main Switches Handle black	EAN-Code 9004257	Main Switches with Emergency Function Handle red Contrasting yellow plate	EAN-Code 9004257
IP 65 64 x 64 	20 A 25 A 32 A	5,5 kW / 120 A 7,5 kW / 180 A 11 kW / 220 A	KG10B T103/17 FT2 KG20B T103/17 FT2 KG32B T103/17 FT2	01302 9 00441 6 00442 3	KG10B T203/17 FT2 KG20B T203/17 FT2 KG32B T203/17 FT2	01303 6 00445 4 00446 1
IP 65 48 x 48 	20 A 25 A 32 A	5,5 kW / 120 A 7,5 kW / 180 A 11 kW / 220 A	KG10A T103/20 FT2 KG20A T103/20 FT2 KG32A T103/20 FT2	01304 3 01306 7 01308 1	KG10A T203/20 FT2 KG20A T203/20 FT2 KG32A T203/20 FT2	01310 4 01312 8 01314 2
64 x 64	20 A 25 A 32 A	5,5 kW / 120 A 7,5 kW / 180 A 11 kW / 220 A	KG10B T103/20 FT2 KG20B T103/20 FT2 KG32B T103/20 FT2	01305 0 01307 4 01309 8	KG10B T203/20 FT2 KG20B T203/20 FT2 KG32B T203/20 FT2	01311 1 01313 5 01315 9

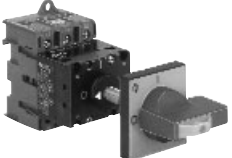
Main Switches and Main Switches with Emergency Function
3 pole + 1 cam-operated auxiliary contact (NO), for Base Mounting
with Door Clutch, Padlock Device and Single Hole Mounting 22 mm

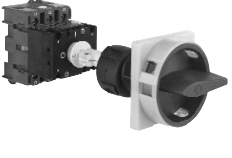
Auxiliary contacts with special contact systems allow for use in low voltage and current applications as well as aggressive environments.

Version	Thermal Current I_U/I_{th}	Ratings AC-23A, AC-23B Breaking Capacity 3 x 380 V/440 V	Main Switches Handle black	EAN-Code 9004257	Main Switches with Emergency Function Handle red Contrasting yellow plate	EAN-Code 9004257
IP 65 48 x 48 	20 A 25 A 32 A 40 A 63 A	5,5 kW / 120 A 7,5 kW / 180 A 11 kW / 220 A 15 kW / 300 A 22 kW / 350 A	KG10A T103/72 VE KG20A T103/72 VE KG32A T103/72 VE KG41 T103/72 VE KG64 T103/72 VE	01342 5 01344 9 01346 3 01348 7 01350 0	KG10A T203/72 VE KG20A T203/72 VE KG32A T203/72 VE KG41 T203/72 VE KG64 T203/72 VE	01354 8 01356 2 01358 6 01360 9 01362 3
64 x 64 	20 A 25 A 32 A 40 A 63 A 80 A 100 A	5,5 kW / 120 A 7,5 kW / 180 A 11 kW / 220 A 15 kW / 300 A 22 kW / 350 A 30 kW / 560 A 37 kW / 650 A	KG10B T103/72 VE KG20B T103/72 VE KG32B T103/72 VE KG41B T103/72 VE KG64B T103/72 VE KG80 T103/72 VE KG100 T103/72 VE	01343 2 01345 6 01347 0 01349 4 01351 7 01352 4 01353 1	KG10B T203/72 VE KG20B T203/72 VE KG32B T203/72 VE KG41B T203/72 VE KG64B T203/72 VE KG80 T203/72 VE KG100 T203/72 VE	01355 5 01357 9 01359 3 01361 6 01363 0 01364 7 01365 4
IP 65 64 x 64  Misalignment between the shaft and operator is compensated for by a centering device.	20 A 25 A 32 A 40 A 63 A 80 A 100 A	5,5 kW / 120 A 7,5 kW / 180 A 11 kW / 220 A 15 kW / 300 A 22 kW / 350 A 30 kW / 560 A 37 kW / 650 A	KG10B T103/95 VE KG20B T103/95 VE KG32B T103/95 VE KG41B T103/95 VE KG64B T103/95 VE KG80 T103/95 VE KG100 T103/95 VE	06427 4 06428 1 06429 8 06430 4 06431 1 06432 8 06433 5	KG10B T203/95 VE KG20B T203/95 VE KG32B T203/95 VE KG41B T203/95 VE KG64B T203/95 VE KG80 T203/95 VE KG100 T203/95 VE	06434 2 06435 9 06436 6 06437 3 06438 0 06439 7 06440 3
IP 65 64 x 64  Misalignment between the shaft and operator is compensated for by a centering device.	20 A 25 A 32 A 40 A 63 A 80 A 100 A	5,5 kW / 120 A 7,5 kW / 180 A 11 kW / 220 A 15 kW / 300 A 22 kW / 350 A 30 kW / 560 A 37 kW / 650 A	KG10B T103/96 VE KG20B T103/96 VE KG32B T103/96 VE KG41B T103/96 VE KG64B T103/96 VE KG80 T103/96 VE KG100 T103/96 VE	06441 0 06442 7 06443 4 06444 1 06445 8 06446 5 06447 2	KG10B T203/96 VE KG20B T203/96 VE KG32B T203/96 VE KG41B T203/96 VE KG64B T203/96 VE KG80 T203/96 VE KG100 T203/96 VE	06448 9 06449 6 06450 2 06451 9 06452 6 06453 3 06454 0

Main Switches and Main Switches with Emergency Function 3 pole + 1 cam- or rack-operated auxiliary contact (NO), for Base Mounting with Door Clutch

Auxiliary contacts with special contact systems allow for use in low voltage and current applications as well aggressive environments.

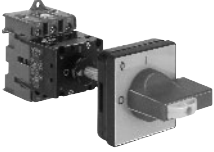
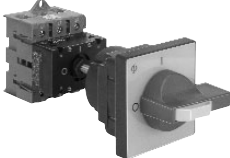
Version	Thermal Current I_u/I_{th}	Ratings AC-23A, AC-23B Breaking Capacity 3 x 380 V/440 V	Main Switches Handle black	EAN-Code 9004257	Main Switches with Emergency Function Handle red Contrasting yellow plate	EAN-Code 9004257
IP 40 ¹ 64 x 64 	20 A 25 A 32 A 40 A 63 A 80 A 100 A	5,5 kW / 120 A 7,5 kW / 180 A 11 kW / 220 A 15 kW / 300 A 22 kW / 350 A 30 kW / 560 A 37 kW / 650 A	KG10B T103/25 VE KG20B T103/25 VE KG32B T103/25 VE KG41B T103/25 VE KG64B T103/25 VE KG80 T103/25 VE KG100 T103/25 VE	01316 6 00449 2 00450 8 00451 5 00452 2 00453 9 00454 6	KG10B T203/25 VE KG20B T203/25 VE KG32B T203/25 VE KG41B T203/25 VE KG64B T203/25 VE KG80 T203/25 VE KG100 T203/25 VE	01317 3 00463 8 00464 5 00465 2 00466 9 00467 6 00468 3
88 x 88	125 A 160 A	45 kW / 750 A 55 kW / 850 A	KG125 T103/25 VE KG160 T103/25 VE	00456 0 00457 7	KG125 T203/25 VE KG160 T203/25 VE	00470 6 00471 3
IP 65 48 x 48 	20 A 25 A 32 A	5,5 kW / 120 A 7,5 kW / 180 A 11 kW / 220 A	KG10A T103/69 VE KG20A T103/69 VE KG32A T103/69 VE	01318 0 01320 3 01322 7	KG10A T203/69 VE KG20A T203/69 VE KG32A T203/69 VE	01330 2 01332 6 01334 0
64 x 64	20 A 25 A 32 A 40 A 63 A 80 A 100 A	5,5 kW / 120 A 7,5 kW / 180 A 11 kW / 220 A 15 kW / 300 A 22 kW / 350 A 30 kW / 560 A 37 kW / 650 A	KG10B T103/69 VE KG20B T103/69 VE KG32B T103/69 VE KG41B T103/69 VE KG64B T103/69 VE KG80 T103/69 VE KG100 T103/69 VE	01319 7 01321 0 01323 4 01325 8 01327 2 01328 9 01329 6	KG10B T203/69 VE KG20B T203/69 VE KG32B T203/69 VE KG41B T203/69 VE KG64B T203/69 VE KG80 T203/69 VE KG100 T203/69 VE	01331 9 01333 3 01335 7 01337 1 01339 5 01340 1 01341 8
IP 65 88 x 88  <p>With integrated door clutch. The handle is restricted if the door is opened. In the I-position the door can be opened with a special key. Possible misalignment of the shaft can be compensated for by the door clutch. To open the door in the I-position an unlock insert S1D M700 29 is available on request. See page 33.</p>	25 A 32 A 40 A 63 A 80 A 100 A 125 A 160 A 200 A 250 A 315 A 315 A	7,5 kW / 180 A 11 kW / 220 A 15 kW / 300 A 22 kW / 350 A 30 kW / 560 A 37 kW / 650 A 45 kW / 750 A 55 kW / 850 A 75 kW / 1100 A 90 kW / 1380 A 110 kW / 1650 A 132 kW / 2000 A	KG20B T103/28 VE KG32B T103/28 VE KG41B T103/28 VE KG64B T103/28 VE KG80 T103/28 VE KG100 T103/28 VE KG125 T103/28 VE KG160 T103/28 VE KG210 T103/29 VE KG250 T103/29 VE KG315 T103/29 VE C316 T103/29 VE	01625 9 00484 3 00485 0 00486 7 00487 4 00488 1 00490 4 00491 1 07530 0 00493 5 00494 2 00495 9	KG20B T203/28 VE KG32B T203/28 VE KG41B T203/28 VE KG64B T203/28 VE KG80 T203/28 VE KG100 T203/28 VE KG125 T203/28 VE KG160 T203/28 VE KG210 T203/29 VE KG250 T203/29 VE KG315 T203/29 VE C316 T203/29 VE	00513 0 00514 7 00515 4 00516 1 00517 8 00518 5 00520 8 00521 5 07531 7 00523 9 00524 6 00525 3

¹Higher protection available on request.

Main Switches and Main Switches with Emergency Function

3 pole, for Four Hole Panel Mounting

with Under-voltage Release² (coil voltage 230 V independent of frequency, from 50 A for 50 Hz)

Version	Thermal Current I_U/I_{th}	Ratings AC-23A, AC-23B Breaking Capacity 3 x 380 V/440 V	Main Switches	EAN-Code 9004257	Main Switches with Emergency Function	EAN-Code 9004257
Protection Escutcheon plate in mm			Handle black		Handle red Contrasting yellow plate	
IP 65 ¹ 64 x 64	20 A 25 A 32 A 50 A 63 A	7,5 kW / 130 A 11 kW / 180 A 15 kW / 250 A 22 kW / 360 A 30 kW / 550 A	CA10Z T103/01 EGF CA20Z T103/01 EGF CA25Z T103/01 EGF C32 T103/82 E C42 T103/82 E	06676 6 06680 3 06684 1 03184 9 03186 3	CA10Z T203/01 EGF CA20Z T203/01 EGF CA25Z T203/01 EGF C32 T203/82 E C42 T203/82 E	06677 3 06681 0 06685 8 03192 4 03194 8
IP 65 48 x 48	20 A 25 A 32 A	7,5 kW / 130 A 11 kW / 180 A 15 kW / 250 A	CA10Z T103/04 EF CA20Z T103/04 EF CA25Z T103/04 EF	06688 9 06696 4 06704 6	CA10Z T203/04 EF CA20Z T203/04 EF CA25Z T203/04 EF	06689 6 06697 1 06705 3
64 x 64	20 A 25 A 32 A	7,5 kW / 130 A 11 kW / 180 A 15 kW / 250 A	CA10Z T103/04 EGF CA20Z T103/04 EGF CA25Z T103/04 EGF	06692 6 06700 8 06708 4	CA10Z T203/04 EGF CA20Z T203/04 EGF CA25Z T203/04 EGF	06693 3 06701 5 06709 1

Main Switches and Main Switches with Emergency Function

3 pole, for Single Hole Mounting 22 mm



with Under-voltage Release² (coil voltage 230 V independent of frequency)

Version	Thermal Current I_U/I_{th}	Ratings AC-23A, AC-23B Breaking Capacity 3 x 380 V/440 V	Main Switches	EAN-Code 9004257	Main Switches with Emergency Function	EAN-Code 9004257
Protection Escutcheon plate in mm			Handle black		Handle red Contrasting yellow plate	
IP 65 64 x 64	20 A 25 A 32 A	7,5 kW / 130 A 11 kW / 180 A 15 kW / 250 A	CA10Z T103/01 FH3 CA20Z T103/01 FH3 CA25Z T103/01 FH3	06712 1 06716 9 06720 6	CA10Z T203/01 FH3 CA20Z T203/01 FH3 CA25Z T203/01 FH3	06713 8 06717 6 06721 3
IP 65 48 x 48	20 A 25 A 32 A	7,5 kW / 130 A 11 kW / 180 A 15 kW / 250 A	CA10Z T103/04 FT2 CA20Z T103/04 FT2 CA25Z T103/04 FT2	06724 4 06728 2 06732 9	CA10Z T203/04 FT2 CA20Z T203/04 FT2 CA25Z T203/04 FT2	06725 1 06729 9 06733 6

Main Switches and Main Switches with Emergency Function

4 pole, for Four Hole Panel Mounting



with Under-voltage Release² (coil voltage 230 V independent of frequency, from 50 A for 50 Hz)

Version	Thermal Current I_u/I_{th}	Ratings AC-23A, AC-23B Breaking Capacity 3 x 380 V/440 V	Main Switches	EAN-Code 9004257	Main Switches with Emergency Function	EAN-Code 9004257
Protection Escutcheon plate in mm			Handle black		Handle red Contrasting yellow plate	
IP 65 ¹ 64 x 64 	20 A 25 A 32 A 50 A 63 A	7,5 kW / 130 A 11 kW / 180 A 15 kW / 250 A 22 kW / 360 A 30 kW / 550 A	CA10Z T104/01 EGF CA20Z T104/01 EGF CA25Z T104/01 EGF C32 T104/82 E C42 T104/82 E	06678 0 06682 7 06686 5 03185 6 03187 0	CA10Z T204/01 EGF CA20Z T204/01 EGF CA25Z T204/01 EGF C32 T204/82 E C42 T204/82 E	06679 7 06683 4 06687 2 03193 1 03195 5
IP 65 48 x 48 	20 A 25 A 32 A	7,5 kW / 130 A 11 kW / 180 A 15 kW / 250 A	CA10Z T104/04 EF CA20Z T104/04 EF CA25Z T104/04 EF	06690 2 06698 8 06706 0	CA10Z T204/04 EF CA20Z T204/04 EF CA25Z T204/04 EF	06691 9 06699 5 06707 7
64 x 64	20 A 25 A 32 A	7,5 kW / 130 A 11 kW / 180 A 15 kW / 250 A	CA10Z T104/04 EGF CA20Z T104/04 EGF CA25Z T104/04 EGF	06694 0 06702 2 06710 7	CA10Z T204/04 EGF CA20Z T204/04 EGF CA25Z T204/04 EGF	06695 7 06703 9 06711 4

Main Switches and Main Switches with Emergency Function

4 pole, for Single Hole Mounting 22 mm

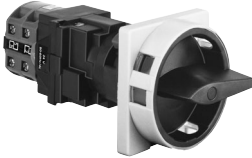











with Under-voltage Release² (coil voltage 230 V independent of frequency)

Version	Thermal Current I_u/I_{th}	Ratings AC-23A, AC-23B Breaking Capacity 3 x 380 V/440 V	Main Switches	EAN-Code 9004257	Main Switches with Emergency Function	EAN-Code 9004257
Protection Escutcheon plate in mm			Handle black		Handle red Contrasting yellow plate	
IP 65 64 x 64 	20 A 25 A 32 A	7,5 kW / 130 A 11 kW / 180 A 15 kW / 250 A	CA10Z T104/01 FH3 CA20Z T104/01 FH3 CA25Z T104/01 FH3	06714 5 06718 3 06722 0	CA10Z T204/01 FH3 CA20Z T204/01 FH3 CA25Z T204/01 FH3	06715 2 06719 0 06723 7
IP 65 48 x 48 	20 A 25 A 32 A	7,5 kW / 130 A 11 kW / 180 A 15 kW / 250 A	CA10Z T104/04 FT2 CA20Z T104/04 FT2 CA25Z T104/04 FT2	06726 8 06730 5 06734 3	CA10Z T204/04 FT2 CA20Z T204/04 FT2 CA25Z T204/04 FT2	06727 5 06731 2 06735 0

¹C32 and C42 protection IP 40. ²Ambient temperature: 35 °C during 24 hours with peaks up to 40 °C.

Maintenance and Safety Switches

3 pole, in Plastic Enclosure (conduit entries for metric¹ threads)













Version	Thermal Current	Ratings AC-23A, AC-23B Breaking Capacity 3 x 380 V/440 V	Main Switches Handle electro-gray Handle black	EAN-Code	Main Switches with Emergency Function Handle red Contrasting yellow plate	EAN-Code
  IP 66/67	20 A	5,5 kW / 120 A	KG10 T103/33 KS51V	06743 5	KG10 T203/33 KS51V	06773 2
	25 A	7,5 kW / 180 A	KG20 T103/33 KS51V	06744 2	KG20 T203/33 KS51V	06774 9
  IP 66/67	20 A	5,5 kW / 120 A	KG10 T103/75 KS51	06745 9	KG10 T203/75 KS51	06775 6
	25 A	7,5 kW / 180 A	KG20 T103/75 KS51	06746 6	KG20 T203/75 KS51	06776 3
  IP 66/67	25 A	7,5 kW / 180 A	KG20 T103/33 KL51V	06747 3	KG20 T203/33 KL51V	06777 0
	32 A	11 kW / 220 A	KG32 T103/33 KL51V ²	06748 0	KG32 T203/33 KL51V ²	06778 7
	40 A	15 kW / 300 A	KG41 T103/33 KL11V	06749 7	KG41 T203/33 KL11V	06779 4
	63 A	22 kW / 350 A	KG64 T103/33 KL11V	06750 3	KG64 T203/33 KL11V	06780 0
	80 A	30 kW / 560 A	KG80 T103/33 KL71V	07454 9	KG80 T203/33 KL71V	07455 6
	100 A	37 kW / 650 A	KG100 T103/33 KL71V	07456 3	KG100 T203/33 KL71V	07457 0
  IP 66/67	25 A	7,5 kW / 180 A	KG20 T103/75 KL51	06753 4	KG20 T203/75 KL51	06783 1
	32 A	11 kW / 220 A	KG32 T103/75 KL51 ²	06754 1	KG32 T203/75 KL51 ²	06784 8
	40 A	15 kW / 300 A	KG41 T103/75 KL11	06755 8	KG41 T203/75 KL11	06785 5
	63 A	22 kW / 350 A	KG64 T103/75 KL11	06756 5	KG64 T203/75 KL11	06786 2
	80 A	30 kW / 560 A	KG80 T103/75 KL71	07279 8	KG80 T203/75 KL71	07281 1
	100 A	37 kW / 650 A	KG100 T103/75 KL71	07280 4	KG100 T203/75 KL71	07282 8
  IP 65	125 A	45 kW / 750 A	KG125 T103/34 STM	06759 6	KG125 T203/34 STM	06789 3
	160 A	55 kW / 850 A	KG160 T103/34 STM	06760 2	KG160 T203/34 STM	06790 9
	125 A	45 kW / 750 A	KG125 T103/76 STM	06761 9	KG125 T203/76 STM	06791 6
	160 A	55 kW / 850 A	KG160 T103/76 STM	06762 6	KG160 T203/76 STM	06792 3
	250 A	90 kW / 1380 A	KG250 T103/36 STM	06763 3	KG250 T203/36 STM	06793 0
	315 A	110 kW / 1650 A	KG315 T103/36 STM ³	06764 0	KG315 T203/36 STM ³	06794 7
  IP 65	315 A	132 kW / 2000 A	C316 T103/37 STM ³	06765 7	C316 T203/37 STM ³	06795 4
	Oversized Wiring Space			Oversized Wiring Space		
	125 A	45 kW / 750 A	KG125 T103/38 STM	06766 4	KG125 T203/38 STM	06796 1
	160 A	55 kW / 850 A	KG160 T103/38 STM	06767 1	KG160 T203/38 STM	06797 8
	125 A	45 kW / 750 A	KG125 T103/36 STM	06768 8	KG125 T203/36 STM	06798 5
	160 A	55 kW / 850 A	KG160 T103/36 STM	06769 5	KG160 T203/36 STM	06799 2
250 A	90 kW / 1380 A	KG250 T103/39 STM ³	06770 1	KG250 T203/39 STM ³	06800 5	
315 A	110 kW / 1650 A	KG315 T103/39 STM ³	06771 8	KG315 T203/39 STM ³	06801 2	
315 A	132 kW / 2000 A	C316 T103/39 STM ³	06772 5	C316 T203/39 STM ³	06802 9	

¹Enclosures with conduit entries for PG thread continue to be available. ²For conduit entries M25 in place of M20 the ordering data changes from KL51V to KL11V and from KL51 to KL11. ³Switches with cable glands. To meet the conditions of EMC (Electro Magnetic Compatibility) for connection of frequency regulated motors, maintenance switches are available with shield clips. These clips are used to continue the cable shield circuit through the enclosure.

Maintenance and Safety Switches

**3 pole + 2 cam- or rack-operated auxiliary contacts (1 NO, 1 NC),
in Plastic Enclosure (conduit entries for metric¹ threads)**













Auxiliary contacts with special contact systems allow for use in low voltage and current applications as well aggressive environments.

Version	Thermal Current	Ratings AC-23A, AC-23B Breaking Capacity 3 x 380 V/440 V	Main Switches Handle electro-gray Handle black	EAN-Code	Main Switches with Emergency Function Handle red Contrasting yellow plate	EAN-Code	
  IP 66/67	20 A	5,5 kW / 120 A	KG10 T103/40 KS51V	06803 6	KG10 T203/40 KS51V	06804 3	
  IP 66/67	20 A	5,5 kW / 120 A	KG10 T103/78 KS51	06805 0	KG10 T203/78 KS51	06806 7	
  IP 66/67	25 A	7,5 kW / 180 A	KG20 T103/40 KL51V	06807 4	KG20 T203/40 KL51V	06808 1	
	32 A	11 kW / 220 A	KG32 T103/40 KL51V ²	06809 8	KG32 T203/40 KL51V ²	06810 4	
	40 A	15 kW / 300 A	KG41 T103/40 KL11V	06811 1	KG41 T203/40 KL11V	06812 8	
	63 A	22 kW / 350 A	KG64 T103/40 KL11V	06813 5	KG64 T203/40 KL11V	06814 2	
	80 A	30 kW / 560 A	KG80 T103/40 KL71V	07458 7	KG80 T203/40 KL71V	07459 4	
	100 A	37 kW / 650 A	KG100 T103/40 KL71V	07460 0	KG100 T203/40 KL71V	07461 7	
 IP 66/67	25 A	7,5 kW / 180 A	KG20 T103/78 KL51	06819 7	KG20 T203/78 KL51	06820 3	
	32 A	11 kW / 220 A	KG32 T103/78 KL51 ²	06821 0	KG32 T203/78 KL51 ²	06822 7	
	40 A	15 kW / 300 A	KG41 T103/78 KL11	06823 4	KG41 T203/78 KL11	06824 1	
	63 A	22 kW / 350 A	KG64 T103/78 KL11	06825 8	KG64 T203/78 KL11	06826 5	
	80 A	30 kW / 560 A	KG80 T103/78 KL71	06827 2	KG80 T203/78 KL71	06828 9	
	100 A	37 kW / 650 A	KG100 T103/78 KL71	06829 6	KG100 T203/78 KL71	06830 2	
  IP 65	125 A	45 kW / 750 A	KG125 T103/41 STM	06831 9	KG125 T203/41 STM	06832 6	
	160 A	55 kW / 850 A	KG160 T103/41 STM	06833 3	KG160 T203/41 STM	06834 0	
	125 A	45 kW / 750 A	KG125 T103/79 STM	06835 7	KG125 T203/79 STM	06836 4	
	160 A	55 kW / 850 A	KG160 T103/79 STM	06837 1	KG160 T203/79 STM	06838 8	
	250 A	90 kW / 1380 A	KG250 T103/43 STM	06839 5	KG250 T203/43 STM	06840 1	
	315 A	110 kW / 1650 A	KG315 T103/43 STM ³	06841 8	KG315 T203/43 STM ³	06842 5	
 IP 65	315 A	132 kW / 2000 A	C316 T103/44 STM ³	06843 2	C316 T203/44 STM ³	06844 9	
	Oversized Wiring Space				Oversized Wiring Space		
	  IP 65	125 A	45 kW / 750 A	KG125 T103/45 STM	06845 6	KG125 T203/45 STM	06846 3
		160 A	55 kW / 850 A	KG160 T103/45 STM	06847 0	KG160 T203/45 STM	06848 7
		125 A	45 kW / 750 A	KG125 T103/43 STM	06849 4	KG125 T203/43 STM	06850 0
		160 A	55 kW / 850 A	KG160 T103/43 STM	06851 7	KG160 T203/43 STM	06852 4
250 A		90 kW / 1380 A	KG250 T103/46 STM ³	06853 1	KG250 T203/46 STM ³	06854 8	
315 A		110 kW / 1650 A	KG315 T103/46 STM ³	06855 5	KG315 T203/46 STM ³	06856 2	
 IP 65	315 A	132 kW / 2000 A	C316 T103/46 STM ³	06857 9	C316 T203/46 STM ³	06858 6	

¹Enclosures with conduit entries for PG thread continue to be available. ²For conduit entries M25 in place of M20 the ordering data changes from KL51V to KL11V and from KL51 to KL11. ³Switches with cable glands. To meet the conditions of EMC (Electro Magnetic Compatibility) for connection of frequency regulated motors, maintenance switches are available with shield clips. These clips are used to continue the cable shield circuit through the enclosure.

Maintenance and Safety Switches

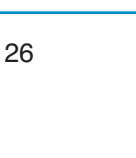
4 pole, in Plastic Enclosure (conduit entries for metric¹ threads)

Version	Thermal Current	Ratings AC-23A, AC-23B Breaking Capacity 3 x 380 V/440 V	Main Switches Handle electro-gray Handle black	EAN-Code	Main Switches with Emergency Function Handle red Contrasting yellow plate	EAN-Code
  IP 66/67	20 A	5,5 kW / 120 A	KG10 T104/33 KS51V	06859 3	KG10 T204/33 KS51V	06860 9
	16 A	7,5 kW / 160 A	KH16 T104/33 KS51V	08805 8	KH16 T204/33 KS51V	08807 2
  IP 66/67	20 A	5,5 kW / 120 A	KG10 T104/75 KS51	06863 0	KG10 T204/75 KS51	06864 7
	16 A	7,5 kW / 160 A	KH16 T104/75 KS51	08806 5	KH16 T204/75 KS51	08808 9
  IP 66/67	20 A	10 kW / 200 A	KH20 T104/33 KL11V	08809 6	KH20 T204/33 KL11V	08810 2
	25 A	12 kW / 250 A	KH25 T104/33 KL11V	08811 9	KH25 T204/33 KL11V	08812 6
	32 A	16 kW / 300 A	KH32 T104/33 KL11V	08813 3	KH32 T204/33 KL11V	08837 9
	40 A	20 kW / 380 A	KH40 T104/33 KL11V	08814 0	KH40 T204/33 KL11V	08838 6
	63 A	30 kW / 500 A	KH63 T104/33 KL71V	08815 7	KH63 T204/33 KL71V	08839 3
	80 A	40 kW / 630 A	KH80 T104/33 KL71V	08816 4	KH80 T204/33 KL71V	08840 9
	100 A	37 kW / 650 A	KG100 T104/33 KL71V	07464 8	KG100 T204/33 KL71V	07465 5
  IP 66/67	20 A	10 kW / 200 A	KH20 T104/75 KL11	08817 1	KH20 T204/75 KL11	08841 6
	25 A	12 kW / 250 A	KH25 T104/75 KL11	08818 8	KH25 T204/75 KL11	08842 3
	32 A	16 kW / 300 A	KH32 T104/75 KL11	08819 5	KH32 T204/75 KL11	08843 0
	40 A	20 kW / 380 A	KH40 T104/75 KL11	08820 1	KH40 T204/75 KL11	08844 7
	63 A	30 kW / 500 A	KH63 T104/75 KL71	08861 4	KH63 T204/75 KL71	08845 4
	80 A	40 kW / 630 A	KH80 T104/75 KL71	08862 1	KH80 T204/75 KL71	08846 1
	100 A	37 kW / 650 A	KG100 T104/75 KL71	06889 0	KG100 T204/75 KL71	06890 6
  IP 65	125 A	45 kW / 750 A	KG125 T104/35 STM	06891 3	KG125 T204/35 STM	06892 0
	160 A	55 kW / 850 A	KG160 T104/35 STM	06893 7	KG160 T204/35 STM	06894 4
	125 A	45 kW / 750 A	KG125 T104/77 STM	06895 1	KG125 T204/77 STM	06896 8
	160 A	55 kW / 850 A	KG160 T104/77 STM	06897 5	KG160 T204/77 STM	06898 2
	250 A	90 kW / 1380 A	KG250 T104/36 STM	06899 9	KG250 T204/36 STM	06900 2
  IP 65	315 A	110 kW / 1650 A	KG315 T104/36 STM ²	06901 9	KG315 T204/36 STM ²	06902 6
	315 A	132 kW / 2000 A	C316 T104/37 STM ²	06903 3	C316 T204/37 STM ²	06904 0
	Oversized Wiring Space			Oversized Wiring Space		
	125 A	45 kW / 750 A	KG125 T104/38 STM	06905 7	KG125 T204/38 STM	06906 4
	160 A	55 kW / 850 A	KG160 T104/38 STM	06907 1	KG160 T204/38 STM	06908 8
 IP 65	125 A	45 kW / 750 A	KG125 T104/36 STM	06909 5	KG125 T204/36 STM	06910 1
	160 A	55 kW / 850 A	KG160 T104/36 STM	06911 8	KG160 T204/36 STM	06912 5
	250 A	90 kW / 1380 A	KG250 T104/47 STM ²	06913 2	KG250 T204/47 STM ²	06914 9
	315 A	110 kW / 1650 A	KG315 T104/47 STM ²	06915 6	KG315 T204/47 STM ²	06916 3
	315 A	132 kW / 2000 A	C316 T104/39 STM ²	06917 0	C316 T204/39 STM ²	06918 7









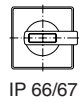

¹Enclosures with conduit entries for PG thread continue to be available. ²Switches with cable glands.

To meet the conditions of EMC (Electro Magnetic Compatibility) for connection of frequency regulated motors, maintenance switches are available with shield clips. These clips are used to continue the cable shield circuit through the enclosure.

Maintenance and Safety Switches

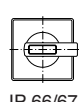
4 pole + 2 cam- or rack-operated auxiliary contacts (1 NO, 1 NC),
in Plastic Enclosure (conduit entries for metric¹ threads)

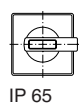

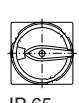
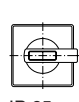







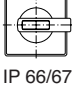

Auxiliary contacts with special contact systems allow for use in low voltage and current applications as well aggressive environments.

Version	Thermal Current	Ratings AC-23A, AC-23B Breaking Capacity 3 x 380 V/440 V	Main Switches Handle electro-gray Handle black	EAN-Code	Main Switches with Emergency Function Handle red Contrasting yellow plate	EAN-Code			
	 IP 66/67	20 A	5,5 kW / 120 A	KG10 T104/40 KS51V	06919 4	KG10 T204/40 KS51V	06920 0		
		16 A	7,5 kW / 160 A	KH16 T104/40 KS51V	08823 2	KH16 T204/40 KS51V	08847 8		
	 IP 66/67	20 A	5,5 kW / 120 A	KG10 T104/78 KS51	06921 7	KG10 T204/78 KS51	06922 4		
		16 A	7,5 kW / 160 A	KH16 T104/78 KS51	08824 9	KH16 T204/78 KS51	08848 5		
	 IP 66/67	20 A	10 kW / 200 A	KH20 T104/40 KL11V	08825 6	KH20 T204/40 KL11V	08849 2		
		25 A	12 kW / 250 A	KH25 T104/40 KL11V	08826 3	KH25 T204/40 KL11V	08850 8		
		32 A	16 kW / 300 A	KH32 T104/40 KL11V	08827 0	KH32 T204/40 KL11V	08851 5		
		40 A	20 kW / 380 A	KH40 T104/40 KL11V	08828 7	KH40 T204/40 KL11V	08852 2		
		63 A	30 kW / 500 A	KH63 T104/40 KL71V	08829 4	KH63 T204/40 KL71V	08853 9		
		80 A	40 kW / 630 A	KH80 T104/40 KL71V	08830 0	KH80 T204/40 KL71V	08854 6		
		100 A	37 kW / 650 A	KG100 T104/40 KL71V	07468 6	KG100 T204/40 KL71V	07469 3		
			 IP 66/67	20 A	10 kW / 200 A	KH20 T104/78 KL11	08831 7	KH20 T204/78 KL11	08855 3
25 A	12 kW / 250 A			KH25 T104/78 KL11	08832 4	KH25 T204/78 KL11	08856 0		
32 A	16 kW / 300 A			KH32 T104/78 KL11	08833 1	KH32 T204/78 KL11	08857 7		
40 A	20 kW / 380 A			KH40 T104/78 KL11	08834 8	KH40 T204/78 KL11	08858 4		
63 A	30 kW / 500 A			KH63 T104/78 KL71	08835 5	KH63 T204/78 KL71	08859 1		
80 A	40 kW / 630 A			KH80 T104/78 KL71	08836 2	KH80 T204/78 KL71	08860 7		
100 A	37 kW / 650 A			KG100 T104/78 KL71	06945 3	KG100 T204/78 KL71	06946 0		
	 IP 65			125 A	45 kW / 750 A	KG125 T104/42 STM	06947 7	KG125 T204/42 STM	06948 4
		160 A	55 kW / 850 A	KG160 T104/42 STM	06949 1	KG160 T204/42 STM	06950 7		
	 IP 65	125 A	45 kW / 750 A	KG125 T104/80 STM	06951 4	KG125 T204/80 STM	06952 1		
		160 A	55 kW / 850 A	KG160 T104/80 STM	06953 8	KG160 T204/80 STM	06954 5		
		250 A	90 kW / 1380 A	KG250 T104/43 STM	06955 2	KG250 T204/43 STM	06956 9		
		315 A	110 kW / 1650 A	KG315 T104/43 STM ²	06957 6	KG315 T204/43 STM ²	06958 3		
		315 A	132 kW / 2000 A	C316 T104/44 STM ²	06959 0	C316 T204/44 STM ²	06960 6		
				Oversized Wiring Space				Oversized Wiring Space	
			 IP 65	125 A	45 kW / 750 A	KG125 T104/45 STM	06961 3	KG125 T204/45 STM	06962 0
				160 A	55 kW / 850 A	KG160 T104/45 STM	06963 7	KG160 T204/45 STM	06964 4
 IP 65	125 A		45 kW / 750 A	KG125 T104/43 STM	06965 1	KG125 T204/43 STM	06966 8		
	160 A		55 kW / 850 A	KG160 T104/43 STM	06967 5	KG160 T204/43 STM	06968 2		
	250 A		90 kW / 1380 A	KG250 T104/48 STM ²	06969 9	KG250 T204/48 STM ²	06970 5		
	315 A		110 kW / 1650 A	KG315 T104/48 STM ²	06971 2	KG315 T204/48 STM ²	06972 9		
315 A	132 kW / 2000 A	C316 T104/46 STM ²	06973 6	C316 T204/46 STM ²	06974 3				

¹Enclosures with conduit entries for PG thread continue to be available. ²Switches with cable glands.

To meet the conditions of EMC (Electro Magnetic Compatibility) for connection of frequency regulated motors, maintenance switches are available with shield clips. These clips are used to continue the cable shield circuit through the enclosure.

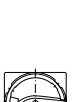
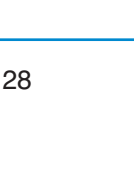
Maintenance and Safety Switches 
6 pole,
in Plastic Enclosure (conduit entries for metric¹ threads)

Version	Thermal Current	Ratings AC-23A, AC-23B Breaking Capacity	Main Switches	EAN-Code	Main Switches with Emergency Function	EAN-Code
  IP 66/67  IP 66/67	I_{the}	3 x 380 V/440 V	Handle electro-gray  Handle black  	9004257	Handle red Contrasting yellow plate	9004257
  IP 66/67	20 A	5,5 kW / 120 A	KG10 T106/33 KS51V	06975 0	KG10 T206/33 KS51V	06976 7
	20 A	5,5 kW / 120 A	KG10 T106/75 KS51	06977 4	KG10 T206/75 KS51	06978 1
  IP 66/67	25 A	7,5 kW / 180 A	KG20B T106/33 KL11V	06979 8	KG20B T206/33 KL11V	06980 4
	32 A	11 kW / 220 A	KG32B T106/33 KL11V	06981 1	KG32B T206/33 KL11V	06982 8
	40 A	15 kW / 300 A	KG41B T106/33 KL71V	07470 9	KG41B T206/33 KL71V	07471 6
	63 A	22 kW / 350 A	KG64B T106/33 KL71V	07472 3	KG64B T206/33 KL71V	07473 0
  IP 66/67	25 A	7,5 kW / 180 A	KG20B T106/75 KL11	06987 3	KG20B T206/75 KL11	06988 0
	32 A	11 kW / 220 A	KG32B T106/75 KL11	06989 7	KG32B T206/75 KL11	06990 3
	40 A	15 kW / 300 A	KG41B T106/75 KL71	06991 0	KG41B T206/75 KL71	06992 7
	63 A	22 kW / 350 A	KG64B T106/75 KL71	06993 4	KG64B T206/75 KL71	06994 1
  IP 65  IP 65	80 A	30 kW / 560 A	KG80C T106/34 STM	06995 8	KG80C T206/34 STM	06996 5
	100 A	37 kW / 650 A	KG100C T106/34 STM	06997 2	KG100C T206/34 STM	06998 9
	125 A	45 kW / 750 A	KG125 T106/84 STM	06999 6	KG125 T206/84 STM	07000 8
	160 A	55 kW / 850 A	KG160 T106/84 STM	07001 5	KG160 T206/84 STM	07002 2
	80 A	30 kW / 560 A	KG80C T106/76 STM	07003 9	KG80C T206/76 STM	07004 6
	100 A	37 kW / 650 A	KG100C T106/76 STM	07005 3	KG100C T206/76 STM	07006 0
IP 65 IP 65	125 A	45 kW / 750 A	KG125 T106/85 STM	07007 7	KG125 T206/85 STM	07008 4
	160 A	55 kW / 850 A	KG160 T106/85 STM	07009 1	KG160 T206/85 STM	07010 7
	275 A	132 kW/2000 A	C316 T106/39 STM ²	07011 4	C316 T206/39 STM ²	07012 1
	Oversized Wiring Space			Oversized Wiring Space		
	125 A	45 kW / 750 A	KG125 T106/86 STM	07013 8	KG125 T206/86 STM	07014 5
	160 A	55 kW / 850 A	KG160 T106/86 STM	07015 2	KG160 T206/86 STM	07016 9
IP 65 IP 65	125 A	45 kW / 750 A	KG125 T106/87 STM	07017 6	KG125 T206/87 STM	07018 3
	160 A	55 kW / 850 A	KG160 T106/87 STM	07019 0	KG160 T206/87 STM	07020 6
	275 A	132 kW/2000 A	C316 T106/47 STM ²	07021 3	C316 T206/47 STM ²	07022 0















¹Enclosures with conduit entries for PG thread continue to be available. ²Switches with cable glands.

To meet the conditions of EMC (Electro Magnetic Compatibility) for connection of frequency regulated motors, maintenance switches are available with shield clips. These clips are used to continue the cable shield circuit through the enclosure.

Maintenance and Safety Switches

**6 pole + 2 cam-operated auxiliary contacts (1 NO, 1 NC),
in Plastic Enclosure (conduit entries for metric¹ threads)**

Auxiliary contacts with special contact systems allow for use in low voltage and current applications as well aggressive environments.





Version	Thermal Current	Ratings AC-23A, AC-23B Breaking Capacity 3 x 380 V/440 V	Main Switches Handle electro-gray Handle black	EAN-Code	Main Switches with Emergency Function	EAN-Code
  IP 66/67	20 A	5,5 kW / 120 A	KG10 T106/40 KS51V	07023 7	KG10 T206/40 KS51V	07024 4
  IP 66/67	25 A	7,5 kW / 180 A	KG20B T106/40 KL11V	07025 1	KG20B T206/40 KL11V	07026 8
	32 A	11 kW / 220 A	KG32B T106/40 KL11V	07027 5	KG32B T206/40 KL11V	07028 2
	40 A	15 kW / 300 A	KG41B T106/40 KL71V	07474 7	KG41B T206/40 KL71V	07475 4
	63 A	22 kW / 350 A	KG64B T106/40 KL71V	07476 1	KG64B T206/40 KL71V	07477 8
  IP 66/67	25 A	7,5 kW / 180 A	KG20B T106/78 KL11	07033 6	KG20B T206/78 KL11	07034 3
	32 A	11 kW / 220 A	KG32B T106/78 KL11	07035 0	KG32B T206/78 KL11	07036 7
	40 A	15 kW / 300 A	KG41B T106/78 KL71	07037 4	KG41B T206/78 KL71	07038 1
	63 A	22 kW / 350 A	KG64B T106/78 KL71	07039 8	KG64B T206/78 KL71	07040 4
  IP 65	80 A	30 kW / 560 A	KG80C T106/41 STM	07041 1	KG80C T206/41 STM	07042 8
	100 A	37 kW / 650 A	KG100C T106/41 STM	07043 5	KG100C T206/41 STM	07044 2
	125 A	45 kW / 750 A	KG125 T106/88 STM	07045 9	KG125 T206/88 STM	07046 6
	160 A	55 kW / 850 A	KG160 T106/88 STM	07047 3	KG160 T206/88 STM	07048 0
  IP 65	80 A	30 kW / 560 A	KG80C T106/79 STM	07049 7	KG80C T206/79 STM	07050 3
	100 A	37 kW / 650 A	KG100C T106/79 STM	07051 0	KG100C T206/79 STM	07052 7
	125 A	45 kW / 750 A	KG125 T106/89 STM	07053 4	KG125 T206/89 STM	07054 1
	160 A	55 kW / 850 A	KG160 T106/89 STM	07055 8	KG160 T206/89 STM	07056 5
	275 A	132 kW/2000 A	C316 T106/46 STM ²	07057 2	C316 T206/46 STM ²	07058 9
			Oversized Wiring Space		Oversized Wiring Space	
  IP 65	125 A	45 kW / 750 A	KG125 T106/90 STM	07059 6	KG125 T206/90 STM	07060 2
	160 A	55 kW / 850 A	KG160 T106/90 STM	07061 9	KG160 T206/90 STM	07062 6
  IP 65	125 A	45 kW / 750 A	KG125 T106/91 STM	07063 3	KG125 T206/91 STM	07064 0
	160 A	55 kW / 850 A	KG160 T106/91 STM	07065 7	KG160 T206/91 STM	07066 4
	275 A	132 kW/2000 A	C316 T106/48 STM ²	07067 1	C316 T206/48 STM ²	07068 8

¹Enclosures with conduit entries for PG thread continue to be available. ²Switches with cable glands.

To meet the conditions of EMC (Electro Magnetic Compatibility) for connection of frequency regulated motors, maintenance switches are available with shield clips. These clips are used to continue the cable shield circuit through the enclosure.

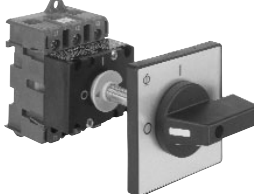
Switch Disconnectors ○ – |

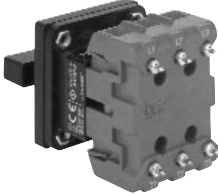
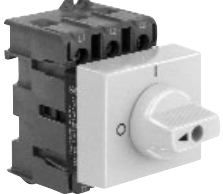

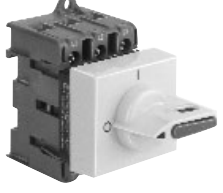
3 pole, Types of Mounting

Technical Data		KG20A KG32A																				
		KG10A	KG20B	KG32B	KG41	KG64	KG80	KG100	KG10B	KG21A ²	KG33A ²	KG41B	KG64B	KG80C	KG100C	KG125	KG160	KG210	KG250	KG315	C316	
Ratings 3 x 380 V/440 V AC-23A, AC-23B AC-3 Thermal Current I _U /I _{th}																						
	kW	5,5	7,5	11	15	22	30	37	45	55	75	90	110	132								
	kW	3,7	5,5	7,5	11	18,5	22	30	37	45	55	55	75	55								
	A	20	25	32	40	63	80	100	125	160	200	250	315	315								
Version Protection	Four Hole Panel Mounting	EAN-Code			Version Protection	Base Mounting			EAN-Code													
		9004257							9004257													
IP 65 ¹ 	KG10A T303 E KG10B T303 E KG20A T303 E KG20B T303 E KG32A T303 E KG32B T303 E KG41 T303 E KG41B T303 E KG64 T303 E KG64B T303 E KG80 T303 E KG80C T303 E KG100 T303 E KG100C T303 E KG125 T303 E KG160 T303 E KG210 T303 E KG250 T303 E KG315 T303 E C316 T303 E	01096 7			IP 40 	KG80 T303 VE KG80C T303 VE KG100 T303 VE KG100C T303 VE KG125 T303 VE KG160 T303 VE KG210 T303 VE KG250 T303 VE KG315 T303 VE C316 T303 VE			00828 5 00829 2 00830 8 00831 5 00833 9 00834 6 08371 8 00836 0 00837 7 00838 4													
		and shaft extension																				
IP 65 	Single Hole Mounting 22 mm					KG10A T303/57 VE KG10B T303/57 VE KG20A T303/57 VE KG20B T303/57 VE KG32A T303/57 VE KG32B T303/57 VE KG41B T303/57 VE KG64B T303/57 VE KG80 T303/57 VE KG80C T303/57 VE KG100 T303/57 VE KG100C T303/57 VE KG125 T303/57 VE KG160 T303/57 VE KG210 T303/57 VE KG250 T303/57 VE KG315 T303/57 VE C316 T303/57 VE	01289 3 01290 9 00839 1 00840 7 00841 4 00842 1 00843 8 00844 5 00845 2 00846 9 00847 6 00848 3 00850 6 00851 3 07533 1 00853 7 00854 4 00855 1															
	KG10A T303 FT2 KG20A T303 FT2 KG32A T303 FT2		02602 9 02603 6 02604 3																			
On request 	Direct-mounting on Printed Circuit Board						Base Mounting for Track															
KG21A T303 E KG33A T303 E		03234 1 03235 8			Esc. plate for 45 mm standard knock-out KG10A T303 VE21 KG20A T303 VE2 KG32A T303 VE2 KG41 T303 VE2 KG64 T303 VE2 KG80 T303 VE2 KG100 T303 VE2			01288 6 00856 8 00857 5 00858 2 00859 9 00860 5 00861 2														
IP 40 	Base Mounting						and padlock device for padlocks KG10A T303/58 VE21 KG20A T303/58 VE2 KG32A T303/58 VE2 KG41 T303/58 VE2 KG64 T303/58 VE2 KG80 T303/58 VE2 KG100 T303/58 VE2			01291 6 00862 9 00863 6 00864 3 00865 0 00866 7 00867 4												
KG10A T303 VE KG10B T303 VE KG20A T303 VE KG20B T303 VE KG32A T303 VE KG32B T303 VE KG41 T303 VE KG41B T303 VE KG64 T303 VE KG64B T303 VE		01098 1 01287 9 00820 9 00821 6 00822 3 00823 0 00824 7 00825 4 00826 1 00827 8																				

¹C316 protection IP 40. Higher protection available on request. ²Further technical data for special applications on printed circuit boards on request.

Switch Disconnectors ○ – |

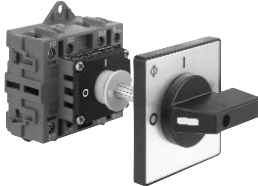

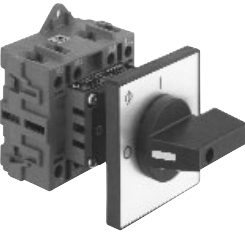



4 pole, Types of Mounting

Technical Data	KH16 KH20 KH25 KH16B KH20B KH25B KH32 KH40 KH63 KH80 KG80 KG100 KG80C KG100C KG125 KG160 KG210 KG250 KG315 C316														
Ratings 3 x 380 V/440 V AC-23A, AC-23B kW AC-3 kW Thermal Current I_u/I_{th} A	7,5	10	12	16	20	30	40	30	37	45	55	75	90	110	132
	5,5	6,5	7,5	11	15	22	30	22	30	37	45	55	55	75	55
	16	20	25	32	40	63	80	80	100	125	160	200	250	315	315
Version Protection	Four Hole Panel Mounting	EAN- Code 9004257	Version Protection	Base Mounting	EAN- Code 9004257										
IP 65 ¹ 	KH16 T304 E KH16B T304 E KH20 T304 E KH20B T304 E KH25 T304 E KH25B T304 E KH32 T304 E KH40 T304 E KH63 T304 E KH80 T304 E KG80C T304 E KG100 T304 E KG100C T304 E KG125 T304 E KG160 T304 E KG210 T304 E KG250 T304 E KG315 T304 E C316 T304 E	07069 5 07070 1 07071 8 07072 5 07073 2 07074 9 06544 8 06545 5 07536 2 07537 9 00877 3 00878 0 00879 7 00881 0 00882 7 07534 8 00884 1 00885 8 00886 5	IP 40 	KG160 T304 VE KG210 T304 VE KG250 T304 VE KG315 T304 VE C316 T304 VE	00903 9 07535 5 00905 3 00906 0 00907 7										
	and shaft extension				KH16 T304/57 VE KH16B T304/57 VE KH20 T304/57 VE KH20B T304/57 VE KH25 T304/57 VE KH25B T304/57 VE KH32 T304/57 VE KH40 T304/57 VE KH63 T304/57 VE KH80 T304/57 VE KG80C T304/57 VE KG100 T304/57 VE KG100C T304/57 VE KG125 T304/57 VE KG160 T304/57 VE KG210 T304/57 VE KG250 T304/57 VE KG315 T304/57 VE C316 T304/57 VE	07084 8 07085 5 07086 2 07087 9 07088 6 07089 3 06548 6 06549 3 07538 6 07539 3 00915 2 00916 9 00917 6 00919 0 00920 6 07540 9 00922 0 00923 7 00924 4									
IP 65 	Single Hole Mounting 22 mm														
	KH16 T304 FT2 KH20 T304 FT2 KH25 T304 FT2	07075 6 07076 3 07077 0													
IP 40 	Base Mounting														
	KH16 T304 VE KH16B T304 VE KH20 T304 VE KH20B T304 VE KH25 T304 VE KH25B T304 VE KH32 T304 VE KH40 T304 VE KH63 T304 VE KH80 T304 VE KG80C T304 VE KG100 T304 VE KG100C T304 VE KG125 T304 VE	07078 7 07079 4 07080 0 07081 7 07082 4 07083 1 06546 2 06547 9 07541 6 07542 3 00898 8 00899 5 00900 8 00902 2													

¹C316 protection IP 40. Higher protection available on request.

Switch Disconnectors ○ – |
6 pole, Types of Mounting

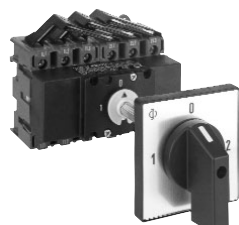
Switch Disconnectors 1 – 0 – 2
Double-throw Switches 3 pole, Types of Mounting

Technical Data		KG10A	KG20A	KG32A	KG41	KG64	KG80	KG100			
		KG10B	KG20B	KG32B	KG41B	KG64B	KG80C	KG100C	KG125	KG160	C316
Ratings 3 x 380 V/440 V AC-23A, AC-23B											
	kW	5,5	7,5	11	15	22	30	37	45	55	132
	AC-3	kW	3,7	5,5	7,5	11	18,5	22	30	37	55
	Thermal Current I_u/I_{th}	A	20	25	32	40	63	80	100	125	160
Version Protection	Four Hole Panel Mounting	EAN-Code 9004257		Version Protection	Four Hole Panel Mounting		EAN-Code 9004257				
IP 65 ¹ 	KG10A	T306 E	01296 1	IP 65 ¹ 	KG20A	T903 E	00958 9				
	KG10B	T306 E	01297 8		KG20B	T903 E	00959 6				
	KG20B	T306 E	00925 1		KG32A	T903 E	00960 2				
	KG32B	T306 E	00926 8		KG32B	T903 E	00961 9				
	KG41B	T306 E	00927 5		KG41B	T903 E	00962 6				
	KG64B	T306 E	00928 2		KG64B	T903 E	00963 3				
	KG80	T306 E	00929 9		KG80	T903 E	00964 0				
	KG80C	T306 E	00930 5		KG80C	T903 E	00965 7				
	KG100	T306 E	00931 2		KG100	T903 E	00966 4				
	KG100C	T306 E	00932 9		KG100C	T903 E	00967 1				
	KG125	T306 E	03683 7		KG125	T903 E	03689 9				
	KG160	T306 E	03685 1		KG160	T903 E	03691 2				
C316	T306 E	00935 0	C316	T903 E	00970 1						
IP 40  	Base Mounting			IP 40   	Base Mounting						
	KG10A	T306 VE	01298 5		KG20B	T903 VE	00971 8				
	KG10B	T306 VE	01299 2		KG32B	T903 VE	00972 5				
	KG20B	T306 VE	00936 7		KG41B	T903 VE	00973 2				
	KG32B	T306 VE	00937 4		KG64B	T903 VE	00974 9				
	KG41B	T306 VE	00938 1		KG80	T903 VE	00975 6				
	KG64B	T306 VE	00939 8		KG80C	T903 VE	00976 3				
	KG80	T306 VE	00940 4		KG100	T903 VE	00977 0				
	KG80C	T306 VE	00941 1		KG100C	T903 VE	00978 7				
	KG100	T306 VE	00942 8		KG125	T903 VE	03690 5				
	KG100C	T306 VE	00943 5		KG160	T903 VE	03692 9				
	KG125	T306 VE	03684 4		C316	T903 VE	00981 7				
	KG160	T306 VE	03686 8		and shaft extension						
	C316	T306 VE	00946 6		KG20B	T903/57 VE	00982 4				
	and shaft extension				KG32B	T903/57 VE	00983 1				
	KG10A	T306/57 VE	01300 5		KG41B	T903/57 VE	00984 8				
	KG10B	T306/57 VE	01301 2		KG64B	T903/57 VE	00985 5				
	KG20B	T306/57 VE	00947 3		KG80	T903/57 VE	00986 2				
KG32B	T306/57 VE	00948 0	KG80C	T903/57 VE	00987 9						
KG41B	T306/57 VE	00949 7	KG100	T903/57 VE	00988 6						
KG64B	T306/57 VE	00950 3	KG100C	T903/57 VE	00989 3						
KG80	T306/57 VE	00951 0	KG125	T903/57 VE	03693 6						
KG80C	T306/57 VE	00952 7	KG160	T903/57 VE	03694 3						
KG100	T306/57 VE	00953 4	C316	T903/57 VE	00992 3						
KG100C	T306/57 VE	00954 1	Base Mounting for Track Esc. plate for 45 mm standard knock-out								
KG125	T306/57 VE	03687 5	KG20A	T903 VE2	06488 5						
KG160	T306/57 VE	03688 2	KG32A	T903 VE2	06489 2						
C316	T306/57 VE	00957 2	KG41B	T903 VE2	06490 8						
			KG64B	T903 VE2	06491 5						
			KG80	T903 VE2	06492 2						
			KG100	T903 VE2	06493 9						

¹C80, C125 and C316 protection IP 40. Higher protection available on request.



Switch Disconnectors - |

3, 4, and 6 pole, in Plastic Enclosure (conduit entries for metric¹ threads)

Technical Data		KG10 KG20 KH16 KH20 KH25 KH32 KH40 KH63 KH80 KG100 KG125 KG160 KG250 KG315 C316 KG20B KG32B KG41B KG64B KG80												
Ratings														
3 x 380 V/440 V														
AC-23A, AC-23B														
AC-3														
Thermal Current I _{the}														
kW														
kW														
A														
Version	3 pole	EAN-Code	Version	4 pole	EAN-Code									
Protection		9004257	Protection		9004257									
IP 66/67	KG10 T303 KS51 KG20 T303 KS51	07283 5 07284 2	IP 65	KG125 T304/60 STM KG160 T304/60 STM KG250 T304/61 STM KG315 T304/61 STM ⁵ C316 T304/62 STM ⁵	07309 2 07310 8 07311 5 07312 2 07313 9									
	KG20 T303 KL51 KG32 T303 KL51 KG41 T303 KL11 KG64 T303 KL11 KG80 T303 KL71 KG100 T303 KL71	07285 9 07286 6 07287 3 07288 0 07289 7 07290 3		Oversized Wiring Space	KG125 T304/61 STM KG160 T304/61 STM KG250 T304/64 STM ⁵ KG315 T304/64 STM ⁵ C316 T304/63 STM ⁵	07314 6 07315 3 07316 0 07317 7 07318 4								
IP 65	KG125 T303/59 STM KG160 T303/59 STM KG250 T303/61 STM KG315 T303/61 STM ⁵ C316 T303/62 STM ⁵	07291 0 07292 7 07293 4 07294 1 07295 8	IP 66/67	6 pole	KG10 T306 KS51 KG20B T306 KL11 KG32B T306 KL11 KG41B T306 KL71 KG64B T306 KL71									
	Oversized Wiring Space	KG125 T303/61 STM KG160 T303/61 STM KG250 T303/63 STM ⁵ KG315 T303/63 STM ⁵ C316 T303/63 STM ⁵				07296 5 07297 2 07298 9 07299 6 07300 9	07319 1 07320 7 07321 4 07322 1 07323 8							
IP 66/67	4 pole	KH16 T304 KS51 KH20 T304 KS11	IP 65	KG80 T306/59 STM KG100 T306/59 STM KG125 T306/59 STM KG160 T306/59 STM C316 T306/63 STM ⁵	07324 5 07325 2 07326 9 07327 6 07328 3									
						Oversized Wiring Space	KG125 T306/61 STM KG160 T306/61 STM C316 T306/64 STM ⁵	07329 0 07330 6 07331 3						
IP 66/67	KH25 T304 KL11 KH32 T304 KL11 KH40 T304 KL11 KH63 T304 KL71 KH80 T304 KL71 KG100 T304 KL71	08763 1 08764 8 08765 5 08766 2 08767 9 08863 8 08864 5 07308 5	IP 65	Oversized Wiring Space	07329 0 07330 6 07331 3									

¹Enclosures with conduit entries for PG thread continue to be available. ²For switches 3 and 4 pole. ³For switches 6 pole. ⁴The values after the slash are valid for KH switches. ⁵Switches with cable glands.

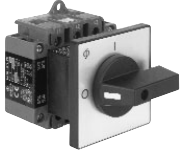
Lateral mounted Auxiliary Contacts

Version	For Switch Type	For Front Mounting	EAN-Code 9004257	For Base Mounting	EAN-Code 9004257
Lateral mounted auxiliary contacts with 1 NO + 1 NC 	KG20-KG32B, KH16-KH25B	K0 H010/A11-E	06473 1	K0 H010/A11-VE	06474 8
	KH32, KH40, KH63, KH80	K1 H010/11A-E	06542 4	K1 H010/11A-VE	06543 1
	KG41-KG64B	K1 H010/A11-E	06475 5	K1 H010/A11-VE	06476 2
	KG80-KG100C	K2 H010/A11-E	06477 9	K2 H010/A11-VE	06478 6
Lateral mounted auxiliary contacts with 2 NO + 1 NC 	KG125, KG160	K3A H010/A21-E	06479 3	K3A H010/A21-VE	06480 9
	KG210, KG250, KG315	K3 H010/A21-E	06481 6	K3 H010/A21-VE	06482 3

Protective Covers

Version	For Switch Type		EAN-Code 9004257		EAN-Code 9004257
	KG10A, KG10B	2 pole	01574 0	3 and 4 pole	01575 7
		S0 M160/A12		S0 M160/A12 K2	
	KG20A, KG20B KG32A, KG32B	3 pole	01576 4	4 pole	01579 5
		K0 M160/3		K0 M160/4	
		K1 M160/3		K1 M160/4	
	KG41, KG41B KG64, KG64B	K2 M160/3	01577 1	K2 M160/4	01580 1
		K3 M160/3		K3 M160/4	
	KG80, KG80C KG100, KG100C	K3 M160/32	01578 8	K3 M160/42	01581 8
		K3 M160/30		K3 M160/40	
	KG125, KG160	For Front Mounting	01582 5	For Base Mounting	01583 2
K1 M160/45-E		K1 M160/45-VE			
KG210, KG250, KG315	K1 M160/44-E	06486 1	K1 M160/44-VE	06487 8	
	K1 M160/45-E		K1 M160/45-VE		
KH32, KH40 KH63, KH80	K1 M160/44-E	09198 0	K1 M160/44-VE	09199 7	
	K1 M160/44-E		K1 M160/44-VE		

Add-on Escutcheon Plates

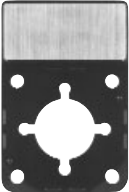
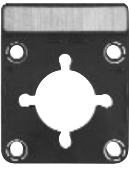
Version Escutcheon Plate frame Black	Description	Escutcheon Plate Size in mm	Escutcheon Plate Backing Brushed Alu	EAN- Code 9004257	Escutcheon Plate Backing Yellow	EAN- Code 9004257	
Higher Inscription field 	HAUPTSCHALTER	48 x 48 64 x 64 88 x 88 130 x 130	S0 F822/A1B - PRA S1 F822/A1B - PRA S2 F822/A1B - PRA S3 F822/A1B - PRA	01538 2 01539 9 01540 5 01541 2	S0 F822/E1B - PRA S1 F822/E1B - PRA S2 F822/E1B - PRA S3 F822/E1B - PRA	01542 9 01543 6 01544 3 01545 0	
	HAUPTSCHALTER NUR IN 0-STELLUNG ÖFFNEN	48 x 48 64 x 64 88 x 88 130 x 130	S0 F832/A1B - PRA S1 F832/A1B - PRA S2 F832/A1B - PRA S3 F832/A1B - PRA	01546 7 01547 4 01548 1 01549 8	S0 F832/E1B - PRA S1 F832/E1B - PRA S2 F832/E1B - PRA S3 F832/E1B - PRA	01550 4 01551 1 01552 8 01553 5	
	HAUPTSCHALTER MAIN SWITCH	48 x 48 64 x 64 88 x 88 130 x 130	S0 F836/A1B - PRA S1 F836/A1B - PRA S2 F836/A1B - PRA S3 F836/A1B - PRA	06335 2 06336 9 06337 6 06338 3	S0 F836/E1B - PRA S1 F836/E1B - PRA S2 F836/E1B - PRA S3 F836/E1B - PRA	06339 0 06340 6 06341 3 06342 0	
	MAIN SWITCH	48 x 48 64 x 64 88 x 88 130 x 130	S0 F824/A1B - PRA S1 F824/A1B - PRA S2 F824/A1B - PRA S3 F824/A1B - PRA	01554 2 01555 9 01556 6 01557 3	S0 F824/E1B - PRA S1 F824/E1B - PRA S2 F824/E1B - PRA S3 F824/E1B - PRA	01558 0 01559 7 01560 3 01561 0	
	INTERRUPTEUR GENERAL	48 x 48 64 x 64 88 x 88 130 x 130	S0 F828/A1B - PRA S1 F828/A1B - PRA S2 F828/A1B - PRA S3 F828/A1B - PRA	01562 7 01563 4 01564 1 01565 8	S0 F828/E1B - PRA S1 F828/E1B - PRA S2 F828/E1B - PRA S3 F828/E1B - PRA	01566 5 01567 2 01568 9 01569 6	
	Lower Inscription field 	HAUPTSCHALTER	48 x 48 64 x 64	S0 F822/A1B - PRC S1 F822/A1B - PRC	00549 9 00552 9	S0 F822/E1B - PRC S1 F822/E1B - PRC	00555 0 01588 7
		HAUPTSCHALTER NUR IN 0-STELLUNG ÖFFNEN	48 x 48 64 x 64	S0 F832/A1B - PRC S1 F832/A1B - PRC	01570 2 01571 9	S0 F832/E1B - PRC S1 F832/E1B - PRC	01572 6 01573 3
		HAUPTSCHALTER MAIN SWITCH	48 x 48 64 x 64	S0 F836/A1B - PRC S1 F836/A1B - PRC	06343 7 06344 4	S0 F836/E1B - PRC S1 F836/E1B - PRC	06345 1 06346 8
		MAIN SWITCH	48 x 48 64 x 64	S0 F824/A1B - PRC S1 F824/A1B - PRC	00550 5 00553 6	S0 F824/E1B - PRC S1 F824/E1B - PRC	00556 7 01589 4
		INTERRUPTEUR GENERAL	48 x 48 64 x 64	S0 F828/A1B - PRC S1 F828/A1B - PRC	00551 2 00554 3	S0 F828/E1B - PRC S1 F828/E1B - PRC	00557 4 01590 0

Terminals for Control Circuit

Version	For Switch Type		EAN-Code 9004257	Max. Permissible Wire Gage Single-core or stranded wire	Flexible wire
	KG41-KG64B	K1B D220 KS	08907 9	2,5 mm ² AWG12	2,5 mm ² AWG14
	KG80-KG100C	K2B D520 KSA	06483 0	2,5 mm ² AWG12	2,5 mm ² AWG14
	KG125, KG160	K3A D720 KS	06484 7	4 mm ² AWG10	4 mm ² AWG12
	KG210, KG250, KG315	K3B D520 KS	06485 4	4 mm ² AWG10	4 mm ² AWG12

Unlock Insert

Version	Unlock insert for the M700		EAN-Code 9004257	
	To open the door in ON position. (After the locking has been made inactive, it is necessary to take effective precautions against an opening of the door by unauthorized persons.)	S1D M700 29	07090 9	

Mounting Key

Version	For Switches with Single Hole Mounting		EAN-Code 9004257	
	Mounting key for locking nut	S00 T170 09	08726 6	

Connection Diagrams

(KG and C switches)

3 pole

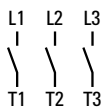

3 pole + 1 NO

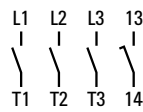

3 pole + 1 NO, 1 NC

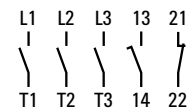

3 pole + PE, N

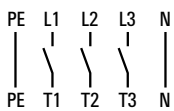

4 pole

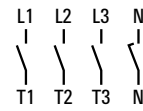

4 pole + 1 NO, 1 NC

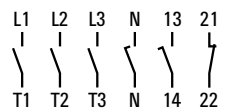

6 pole

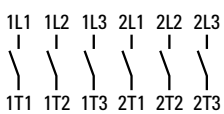

6 pole + 1 NO, 1 NC

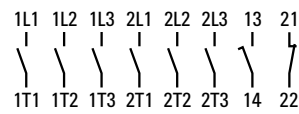

3 pole (Double-throw switches)

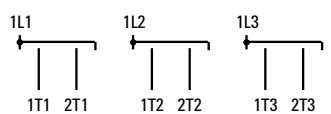

Connection Diagrams

(KH switches)

4 pole

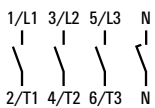

Connection Diagrams

(CA and C switches with under-voltage release)

3 pole

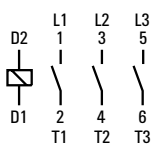

4 pole

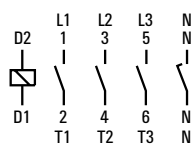

Switches for Panel Mounting

Two or Four Hole Panel Mounting

Dimensions mm
inch

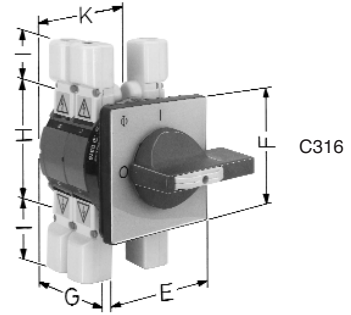
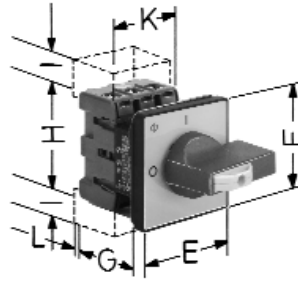
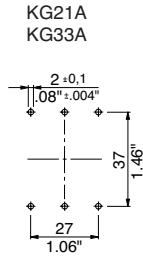
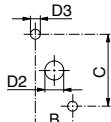
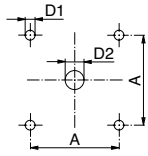

	Pole													Pole						
	A	B ²	C ²	D1	D2	D3	E/F	2	3, 4	3+1	3+N, PE	6 ¹	H	I	2, 3, 3+1	3+N, PE	4	6 ¹	L	
KG10A	36 1.42	12,2 .48	30 1.18	5 .20	11-15 .43-.59	3,5 .14	48 1.89	38,7 1.52	48,2 1.90	48,2 1.90		58 2.28	50 1.97	7,5 .30	48 1.89		48 1.89			
KG10B	48 1.89	12,2 .48	30 1.18	5 .20	11-15 .43-.59	3,5 .14	64 2.52	45,7 1.80	55,2 2.17	55,2 2.17		67 2.64	50 1.97	7,5 .30	48 1.89		48 1.89			
KG20A, KG32A, KG21A, KG33A	36 1.42	12,2 .48	30 1.18	5 .20	10 .39	3,5 .14	48 1.89		53,8 ³ 2.12	62,8 2.47	53,8 2.12	61,3 2.42	54 2.13	20 .79	42 1.65	69 2.72	56 2.21		6 .24	
KG20B, KG32B	48 1.89	12,2 .48	30 1.18	5 .20	10 .39	3,5 .14	64 2.52		53,8 2.12	62,8 2.47	53,8 2.12	61,3 2.42	54 2.13	20 .79	42 1.65	69 2.72	56 2.21	84 3.31	6 .24	
KG41, KG64	36 1.42			5 .20	10 .39		48 1.89		60,5 2.38		60,5 2.38	61,3 2.42	64 2.52	17 .67	50 1.97	82 3.23	66 2.60		5,5 .22	
KG41B, KG64B	48 1.89	12,2 .48	30 1.18	5 .20	10 .39	3,5 .14	64 2.52		60,5 2.38	73 2.87	60,5 2.38	66,5 2.62	64 2.52	17 .67	50 1.97	82 3.23	66 2.60	100 3.94	5,5 .22	
				14 .55	37 1.46		4,5 .18													
KG41B T..3/81 E, KG64B T..3/81 E	68 2.68			6 .24	10 .39		88 3.46		61 2.40				64 2.52	17 .67	50 1.97					5,5 .22
KG80, KG100	48 1.89	14 .55	37 1.46	5 .20	10 .39	4,5 .18	64 2.52		70,6 2.78	80,6 3.17	70,6 2.78	81,8 3.22	80 3.15	26 1.02	70 2.76	114 4.49	92 3.62	140 5.51	5,5 .22	
KG80C, KG100C	68 2.68	14 .55	37 1.46	6 .24	10 .39	4,5 .18	88 3.46		70,6 2.78	80,6 3.17	70,6 2.78	81,8 3.22	80 3.15	26 1.02	70 2.76	114 4.49	92 3.62	140 5.51	5,5 .22	
KG125, KG160	68 2.68			6 .24	13 .51		88 3.46		96 3.78	117 4.61	96 3.78	98 3.86	108 4.25	22,2 .87	112 4.41	188 7.40	150 5.91	224 8.82		
KG210, KG250, KG315	68 2.68			6 .24	13 .51		88 3.46		103 4.06	124 4.88	103 4.06		126 4.96	25 .98	145 5.71	250 9.84	197,5 7.78		6 .24	
KH16, KH20, KH25	36 1.42	12,2 .48	30 1.18	5 .20	10-15 .39	3,5 .14	48 1.89		49 1.93				56 2.20					60 2.36		
KH16B, KH20B, KH25B	48 1.89	12,2 .48	30 1.18	5 .20	10-15 .39	3,5 .14	64 2.52		49 1.93				56 2.20					60 2.36		
KH32, KH40	48 1.89	12,2 .48	30 1.18	5 .20	10-15 .39-.59	3,5 .14	64 2.52		54 2.13				62 2.44	14 .55			70 2.76			
KH63, KH80	48 1.89	14 .55	37 1.46	5 .20	10-15 .39-.59	3,5 .14	64 2.52		62 2.44				90 3.54	23,5 .93			86 3.39		3,5 .14	
C316	104 4.09			7 .28	16 .63		130 5.12		117,2 4.61	137,2 5.40		155,8 6.13	150 5.91	46 1.81	128 5.04		128 5.04	128 5.04		

¹Also valid for double-throw switches. ²Only for main switches and main switches with emergency function. ³KG21A and KG33A G = 56,1 mm/2.21 inch.

Single Hole Mounting 22 mm

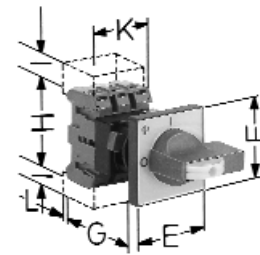
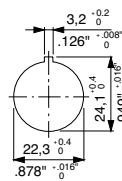

	E/F			Pole				Pole					
	E/F	E/F	E/F	2	3, 4	3+1	3+N, PE	H	I	2, 3, 3+1	3+N, PE	4	L
KG10A	49 1.93	48 1.89		56,6 2.23	66,1 2.60	66,1 2.60		50 1.97	7,5 .30	48 1.89		48 1.89	
KG10B		64 2.52	64 2.52	56,6 2.23	66,1 2.60	66,1 2.60		50 1.97	7,5 .30	48 1.89		48 1.89	
KG20A, KG32A	49 1.93	48 1.89			68,3 2.69	77,3 3.04	68,3 2.69	54 2.13	20 .79	42 1.65	69 2.72	56 2.20	6 .24
KG20B, KG32B		64 2.52	64 2.52		68,3 2.69	77,3 3.04	68,3 2.69	54 2.13	20 .79	42 1.65	69 2.72	56 2.20	6 .24
KH16, KH20, KH25 FT2	49 1.93	48 1.89			63,5 2.50			56 2.20				60 2.36	
KH16, KH20, KH25 FH3		64 2.52	64 2.52		63,5 2.50			56 2.20				60 2.36	
KH32, KH40		64 2.52	64 2.52		68,7 2.70			62 2.44	14 .55			70 2.76	
KH63, KH80		64 2.52	64 2.52		77,1 3.04			90 3.54	23,5 .93			86 3.39	

Switches for Base Mounting

Dimensions mm inch

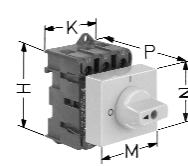
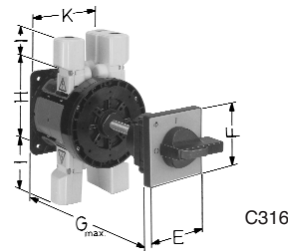
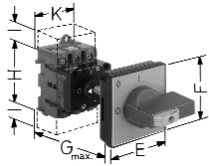

Switch Disconnectors

Main Switches and Main Switches with Emergency Function

	With shaft extension				With single hole mounting without centering device																
	Pole 3, 4		6 ¹		3, 4, 6 ¹		2		3, 4, 3 + N, PE ³		3 + 1		Pole 3,3+1		3 + N, PE		4		6 ¹		6 ¹
	E/F	G	G	G	E/F ²	G	G	G	G	H	I	K	K	K	K	M	N	P	P	P	P
KG10A	48 1.89	61,2 2.41	70,7 2.78	190 7.48	48 1.89	190 7.48	151,2 5.95	160,7 6.33	160,7 6.33	50 1.97		48 1.89		48 1.89	48 1.89	52 2.05	44,7 1.76	64,3 2.53			
KG10B	64 2.52	85,2 3.35	94,7 3.73	190 7.48	64 2.52	190 7.48	160,2 6.31	169,7 6.68	169,7 6.68	50 1.97		48 1.89		48 1.89	48 1.89						
KG20A, KG32A	48 1.89	62 2.44		190 7.48	48 1.89	190 7.48		166,5 6.56	175,5 6.91	54 2.13	20 .79	42 1.65	69 2.72	55,5 2.19	84 3.31	43,3 1.70	44,2 1.74	61 2.40	69 2.72		
KG20B, KG32B	64 2.52	63,5 2.50	71 2.80	190 7.48	64 2.52	190 7.48		166,5 6.56	175,5 6.91	54 2.13	20 .79	42 1.65	69 2.72	55,5 2.19	84 3.31						
KG41, KG64	48 1.89	73 2.87		190 ⁵ 7.48	48 1.89	190 ⁵ 7.48		183,5 7.22	193,5 7.62	64 2.52	17 .67	50 1.97	82 3.23	66 2.60		52 2.05	44,4 1.75	61,5 2.42			
KG41B, KG64B	64 2.52	74,5 2.93	80,5 3.17	190 ⁵ 7.48	64 2.52	190 ⁵ 7.48		183,5 7.22	193,5 7.62	64 2.52	17 .67	50 1.97	82 3.23	66 2.60	100 3.94				67,5 2.66		
KG80	64 2.52	81,5 3.21	92,7 3.65	380 14.96	64 2.52	380 14.96		187,5 7.38	197,5 7.78	80 3.15	26 1.02	70 2.76	114 4.49	92 3.62	140 5.51	70 2.76	45 1.77	70 2.76			
KG80C	88 3.47	81,5 3.21	92,7 3.65	380 14.96	88 3.47	380 14.96															
KG100	64 2.52	81,5 3.21	92,7 3.65	450 17.72	64 2.52	450 17.72		187,5 7.38	197,5 7.78	80 3.15	26 1.02	70 2.76	114 4.49	92 3.62	140 5.51	70 2.76	45 1.77	70 2.76			
KG100C	88 3.47	81,5 3.21	92,7 3.65	450 17.72	88 3.47	450 17.72															
KG125, KG160	88 3.47	107 4.21	109 4.29	450 17.72	88 3.47	450 17.72				108 4.25	22,2 .87	112 4.41	188 7.40	150 5.91	224 8.82						
KG210, KG250, KG315	88 3.47	114 4.49		550 21.65	88 3.47	550 21.65				126 4.96	25 .98	145 5.71	250 9.84	197,5 7.78							
KH16, KH20, KH25	48 1.89	59 2.32		190 7.48	48 1.89	190 7.48		163,5 6.44		56 2.20				60 2.36							
KH16B, KH20B, KH25B	64 2.52	60,5 2.38		190 7.48	64 2.52	190 7.48		163,5 6.44		56 2.20				60 2.36							
KH32, KH40	64 2.52	79 3.11		190 7.48	64 2.52	190 7.48		178 7.01		62 2.44	14 .55			70 2.76							
KH63, KH80	64 2.52	85 3.35		330 ⁶ 12.99	64 2.52	330 ⁶ 12.99		187,5 7.38		90 3.54	23,5 .93			86 3.39							
C316	130 5.12	148 5.83	186,5 7.34	550 21.65	88 3.47	550 21.65				150 5.91	46 1.81	128 5.04		128 5.04	128 5.04						

	Bottom Plate					Front Plate			
	A	B	C	C1	D1	E ⁴	D3 ⁴	D2	D2 ⁴
KG10A						36	5	8-15	18-22
KG10B						1.42	.20	.32-.59	.71-.87
KG20A, KG32A	22	60			4,1	36	5	8-15	18-22
KG20B, KG32B	.87	2.36			.16	1.42	.20	.32-.59	.71-.87
KG41, KG64	25	70			4,1	36	5	8-15	18-22
KG41B, KG64B	.98	2.76			.16	1.42	.20	.32-.59	.71-.87
KG80, KG100	25	90			4,1	48	5	10-15	19-22
KG80C, KG100C	.98	3.54			.16	1.89	.20	.39-.59	.75-.87
KG125, KG160	36	120			6,4	68	6	13-17	26-30
KG250, KG315	44	142			6,4	68	6	13-17	26-30
KH16, KH20, KH25	22	60			.25	2.68	.24	.51-.67	1.02-1.18
KH16B, KH20B, KH25B	.86	2.36			.17	1.42	.20	.32-.59	.71-.87
KH32, KH40	25	70			4,2	36	5	8-15	18-22
KH63, KH80	.98	2.76			.16	1.89	.20	.39-.59	.75-.87
C316	104	104			7	104	7	15,5-20	.61-.79

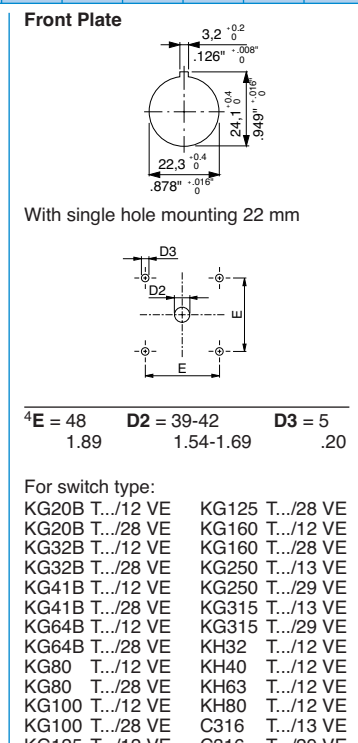
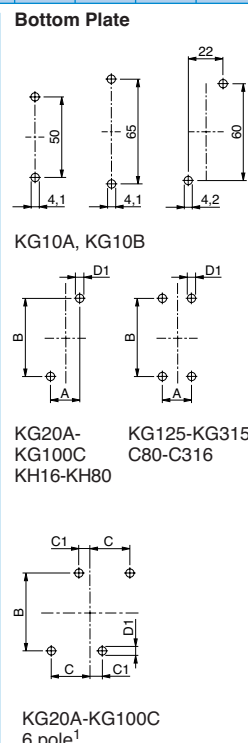

¹Also valid for double-throw switches. ²Versions T.../12 VE, T.../13 VE, T.../28 VE, T.../29 VE = 88 mm/3.47 inch. ³KG10A and KG10B + 9,5 mm/.37 inch. ⁴Different dimensions see right table. ⁵KG64 and KG64B G = 330 mm/12.99 inch. ⁶KH80 G = 380 mm/14.96 inch.

Switches with Under-voltage Release

Dimensions mm
inch

E

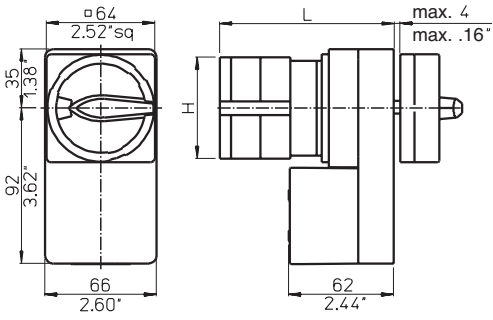

	H	L
C32	60	102,8
	2.36	4.05
C42	66	110,8
	2.60	4.36

EF

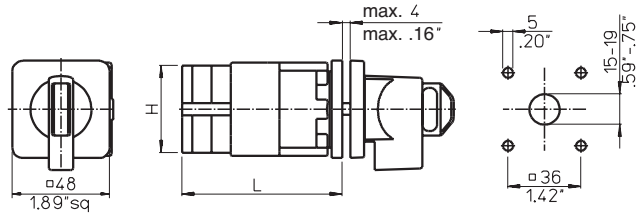

	H	L
CA10Z	43	79
	1.69	3.11
CA20Z	45	86,4
	1.77	3.40
CA25Z	48	89
	1.89	3.50

EGF (/01)

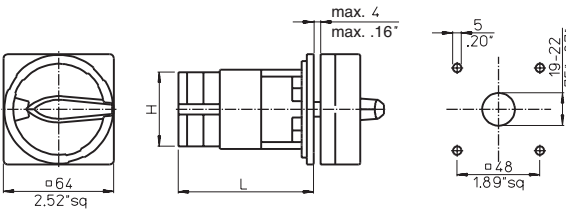

	H	L
CA10Z	43	78,7
	1.69	3.10
CA20Z	45	86,1
	1.77	3.39
CA25Z	48	88,7
	1.89	3.49

EGF (/04)

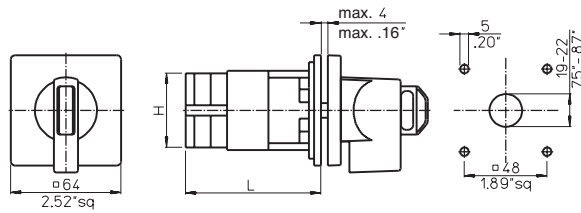

	H	L
CA10Z	43	78,7
	1.69	3.10
CA20Z	45	86,1
	1.77	3.39
CA25Z	48	88,7
	1.89	3.49

FH3

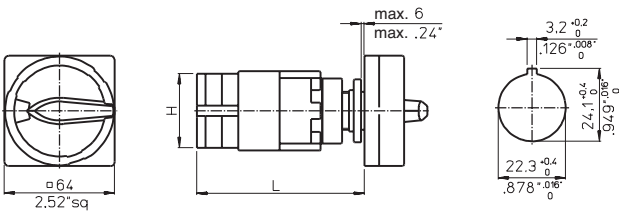

	H	L
CA10Z	43	97,2
	1.69	3.83
CA20Z	45	104,6
	1.77	4.12
CA25Z	48	107,2
	1.89	4.22

FT2

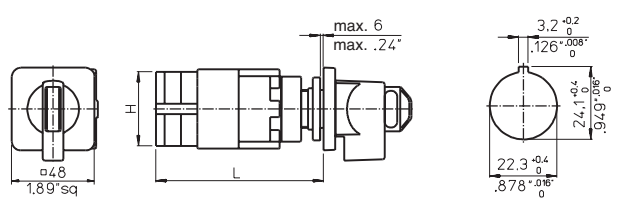

	H	L
CA10Z	43	97,2
	1.69	3.83
CA20Z	45	104,6
	1.77	4.12
CA25Z	48	107,2
	1.89	4.22

Switches in Plastic Enclosure

Dimensions mm inch

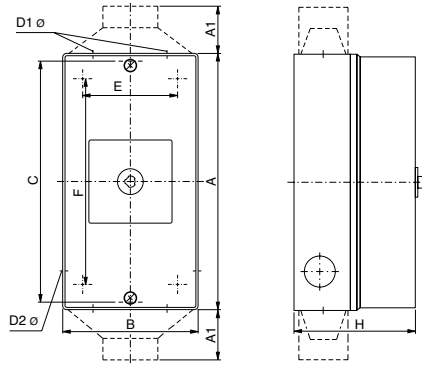

	Pole						A	A1	B	C	D1	D2	E	F	H
	3	3 + 2	4	4 + 2	6	6 + 2									
KG10 T... KS51	x	x	x	x	x		120		85	110	2 x 20	20			80
KH16 T... KS51 ²							4.72		3.35	4.33	2 x .79	.79			3.15
KG10 T... KS51V	x	x	x	x	x	x	120		85	110	2 x 20	20			90
KH16 T... KS51V ²							4.72		3.35	4.33	2 x .79	.79			3.54
KG20 T... KS51	x						120		85	110	2 x 20	20			80
							4.72		3.35	4.33	2 x .79	.79			3.15
KG20 T... KS51V	x						120		85	110	2 x 20	20			90
							4.72		3.35	4.33	2 x .79	.79			3.54
KG20 ¹ , KG32 T... KL51	x	x					160		85	150	2 x 20	20			78
							6.30		3.35	5.91	2 x .79	.79			3.07
KG20 ¹ , KG32 T... KL51V	x	x					160		85	150	2 x 20	20			82
							6.30		3.35	5.91	2 x .79	.79			3.23
KH20 T... KS11				x			120		85	110	2 x 25	20			80
							4.72		3.35	4.33	2 x .98	.79			3.15
KH20, KH25 T... KL11			x	x			160		85	150	2 x 25	20			78
							6.30		3.35	5.91	2 x .98	.79			3.07
KH20, KH25 T... KL11V			x	x			160		85	150	2 x 25	20			82
							6.30		3.35	5.91	2 x .98	.79			3.23
KG20B, KG32B T... KL11					x	x	190		100	178	2 x 25	25			91
							7.48		3.94	7.01	2 x .98	.98			3.58
KG20B, KG32B T... KL11V					x	x	190		100	178	2 x 25	25			93
							7.48		3.94	7.01	2 x .98	.98			3.66
KG41, KG64 T... KL11 KH32, KH40 T... KL11 ²	x	x	x	x			190		100	178	2 x 25	25			91
							7.48		3.94	7.01	2 x .98	.98			3.58
KG41, KG64 T... KL11V KH32, KH40 T... KL11V ²	x	x	x	x			190		100	178	2 x 25	25			93
							7.48		3.94	7.01	2 x .98	.98			3.66
KG41B, KG64B					x	x	250		145		2 x 40	25	124	229	107
							9.84		5.71		2 x 1.57	.98	4.88	9.02	4.21
KG80, KG100 KH63, KH80 ²	x	x	x	x			250		145		2 x 40	25	124	229	107
							9.84		5.71		2 x 1.57	.98	4.88	9.02	4.21
KG80, KG80C KG100, KG100C					x	x	300		200		2 x 40/50	3 x 20	172	272	172
							11.81		7.87		2 x 1.57/1.97	3 x .79	6.77	10.71	6.77
KG125, KG160	x	x					300		200		2 x 40/50	3 x 20	172	272	172
							11.81		7.87		2 x 1.57/1.97	3 x .79	6.77	10.71	6.77
			x	x			280		280		2 x 50	1 x 20	254	254	180
							11.02		11.02		2 x 1.97	1 x .79	10.00	10.00	7.09
	x ¹	x ¹	x ¹	x ¹			380		280		2 x 63	1 x 20	254	354	180
							14.96		11.02		2 x 2.48	1 x .79	10.00	13.94	7.09
					x	x	300		300		2 x 50	1 x 20	272	272	172
							11.81		11.81		2 x 1.97	1 x .79	10.71	10.71	6.77
					x ¹	x ¹	400		300		2 x 63	1 x 20	272	372	172
							15.75		11.81		2 x 2.48	1 x .79	10.71	14.65	6.77
KG250	x	x	x	x			380		280		2 x 63	1 x 20	254	354	180
							14.96		11.02		2 x 2.48	1 x .79	10.00	13.94	7.09
	x ¹	x ¹					560	110	280		1 x 28-60 ³	2 x 20	254	534	180
							22.05	4.33	11.02		1 x 1.10-2.36	2 x .79	10.00	21.02	7.09
			x ¹	x ¹			560	110	380		1 x 28-60 ³	2 x 20	354	534	180
							22.05	4.33	14.96		1 x 1.10-2.36	2 x .79	13.94	21.02	7.09
KG315	x	x	x	x			380	110	280		1 x 28-60 ³	2 x 20	254	354	180
							14.96	4.33	11.02		1 x 1.10-2.36	2 x .79	10.00	13.94	7.09
	x ¹	x ¹					560	110	280		1 x 28-60 ³	2 x 20	254	534	180
							22.05	4.33	11.02		1 x 1.10-2.36	2 x .79	10.00	21.02	7.09
			x ¹	x ¹			560	110	380		1 x 28-60 ³	2 x 20	354	534	180
							22.05	4.33	14.96		1 x 1.10-2.36	2 x .79	13.94	21.02	7.09
C316	x	x	x	x			380	110	280		1 x 28-60 ³	2 x 20	254	354	230
							14.96	4.33	11.02		1 x 1.10-2.36	2 x .79	10.00	13.94	9.06
	x ¹	x ¹	x ¹	x ¹			560	110	280		1 x 28-60 ³	2 x 20	254	534	230
							22.05	4.33	11.02		1 x 1.10-2.36	2 x .79	10.00	21.02	9.06
					x		560	110	280		2 x 28-60 ³	2 x 20	254	534	230
							22.05	4.33	11.02		2 x 1.10-2.36	2 x .79	10.00	21.02	11.02
					x ¹		560	110	380		2 x 28-60 ³	2 x 20	354	534	230
							22.05	4.33	14.96		2 x 1.10-2.36	2 x .79	13.94	21.02	9.06
						x ¹	560	110	380		2 x 28-60 ³	2 x 20	354	534	280
							22.05	4.33	14.96		2 x 1.10-2.36	2 x .79	13.94	21.02	11.02
K100	x	x					250		187.5		1 x 32	6 x 20	199.5	262	153
							9.84		7.38		1 x 1.26	6 x .79	7.85	10.31	6.02
K160	x	x					375		250		1 x 50	6 x 25	262	387	153
							14.76		9.84		1 x 1.97	6 x 0.98	10.32	15.24	6.02
K250	x	x					750		375		3 x 14-68 ³		387	762	204
							29.53		14.76		3 x .55-2.68		15.24	30.00	8.03

¹Oversized wiring space. ²Pole 4 and 4+2. ³outside cable diameter

NOTES

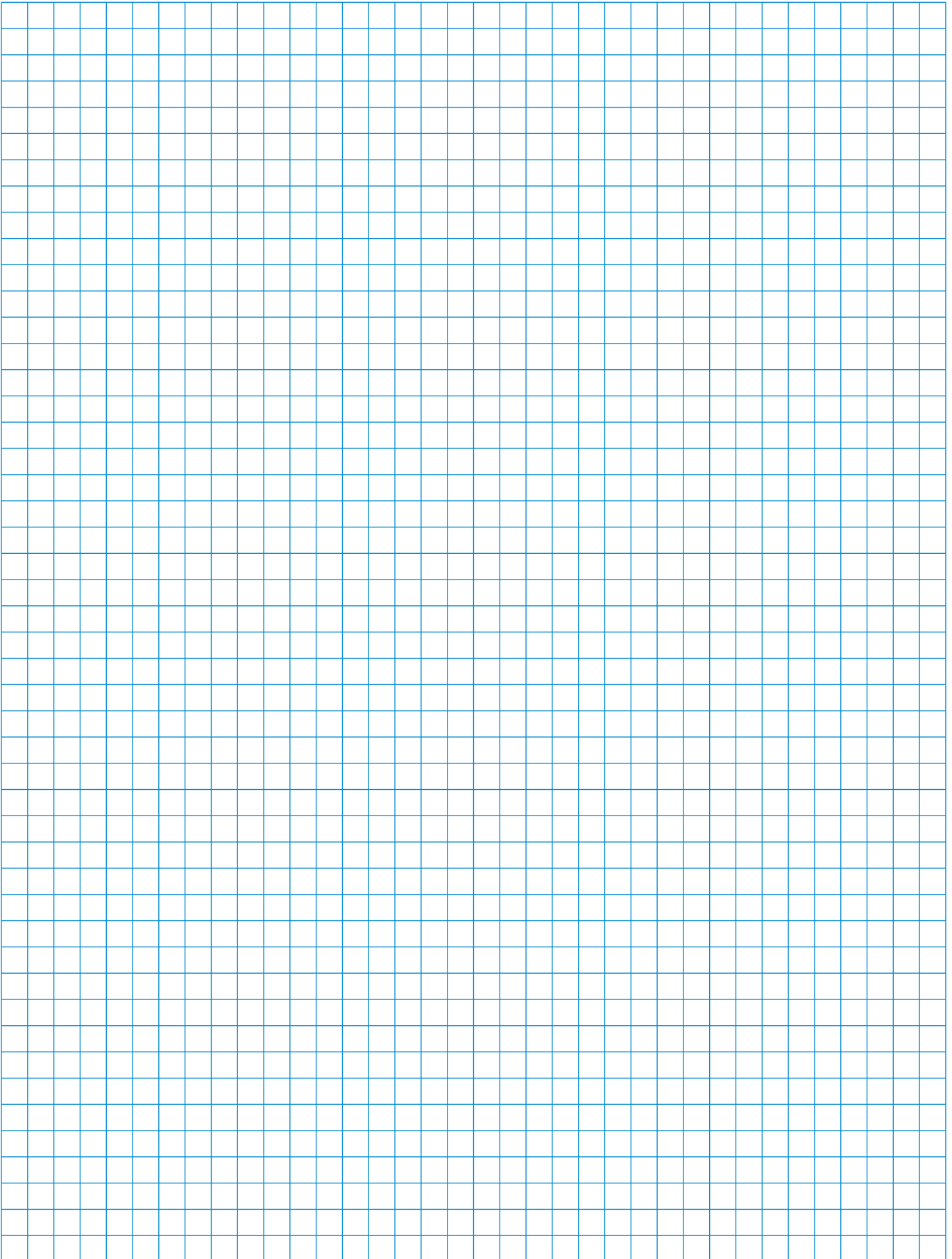

NOTES

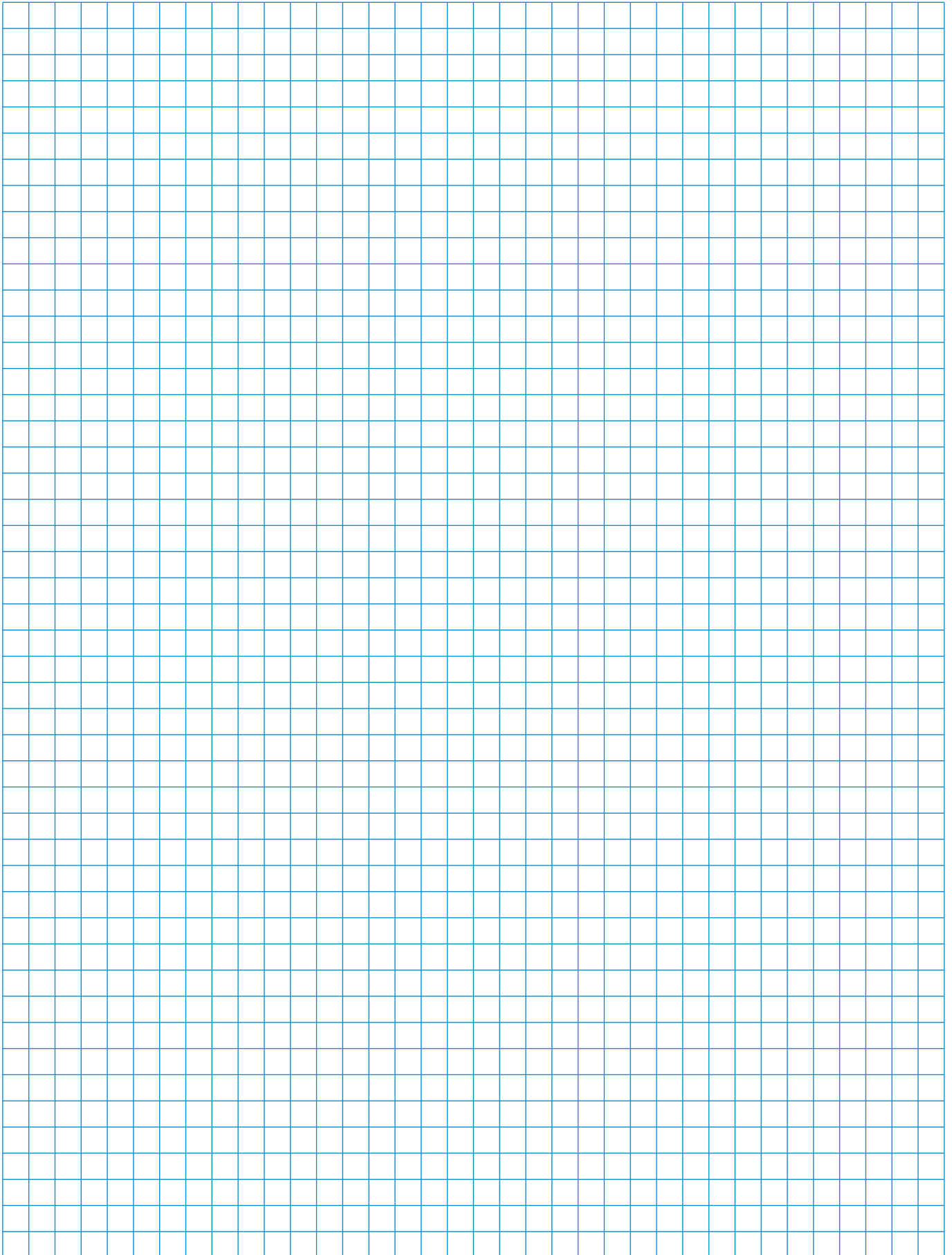

The Range of “Blue Line” Switchgear

Technical literature covering the following products is available on request.

	Catalog Number
Main Switches and Main Switches with Emergency Function 16 A-315 A Maintenance Switches 20 A-315 A Switch Disconnectors 20 A-315 A According to IEC 60947-3, EN 60947-3, VDE 0660 part 107, IEC 60204, EN 60204 and VDE 0113	500
CL Switches 10 A-20 A C, CA and CAD Switches 10 A-315 A and L Switches 350 A-2400 A C, CA and CAD switches are designed for universal application. They are recommended for instrument, isolator, double-throw and motor control. L switches are designed for load and off-load applications. They are used to switch resistive or low inductive loads.	100
Optional Extras and Enclosures The complete product line, a large number of optional extras is available, including door interlocks, push-pull devices, cylinder and padlock attachments, control and indicator devices, AC motor drives, as well as enclosures, both insulated and metal.	101
A and AD Switches 6 A-25 A A and AD switches have 4 contacts in each switching stage. These switches provide an extensive range of switch functions and require a minimum mounting depth. Up to 36 switching positions are possible, with availability of 48 contacts per 12 stage switch column.	110
CG, CH and CHR Switches 10 A-25 A Ultra compact CG, CH and CHR switches are ideally suited for control and instrumentation applications. CG switch terminals are “finger-proof”, according to VDE 0106. Terminals are conveniently accessible for wiring and are delivered open. All CG4 switches offer specially designed gold plated contacts or H-bridges with “cross-wire” contact systems, which facilitates their use in electronic circuitry and chemically aggressive environments.	120
DH, DHR, DK and DKR Switches 6 A-16 A DH, DHR, DK and DKR switches incorporate unique corrosion resistant contacts that permit operation on system voltage as low as 1 V. They have fully enclosed and protected contacts which can be operated either by rotary and/or lateral handle movement. D switches are used in calibration and semiconductor circuits. They are also used for relay and contactor control.	130
X Switches 80 A-630 A X switches can be applied for load, tap and gang switching duties. They incorporate 6 contacts in each switching stage. Their compact design provides a minimum length dimension for mounting purposes.	140
KG Switches 20 A-315 A and KH and KHR Switches 16 A-80 A KG, KH and KHR switches are excellent circuit interruptors. They have high through fault and fault making capacities and are especially designed for use as isolators and safety switches for machine tools, distribution panels and switchboards. KG ON/OFF switches offer unusually high dimensioned air and creepage distances between terminals which are designed for time saving “straight-line” wiring. ON/OFF switches are available with up to 8 poles and double-throw switches are available with up to 4 poles.	150
Contactors 16 A-115 A and Motor Starters 1,1 kW-55 kW These include control relays, motor contactors, two and four pole output contactors, heating contactors, thermal overload relays.	200
Push Buttons and Pilot Lights, 22,5 mm Ø A complete range of state-of-the-art push buttons and pilot lights represent an ideal combination of functional security and economical efficiency in a modular design.	302

SALES AND SERVICE ORGANIZATION

Australia

australian solenoid Φ co. pty. ltd.

379 Liverpool Road, ASHFIELD, N.S.W. 2131
P. O. Box 1093, ASHFIELD, N.S.W. 1800
Tel: +61 2 9797-7333, Fax: 0092
e-mail: sales@austrasol.com.au

Austria

austro solenoid Φ ges.m.b.h.

Schumanngasse 35, Postfach 431
A-1181 WIEN
Tel: +43 1 404 06, Fax: 404 06-190
e-mail: aso@krausnaimer.com

Belgium, Luxembourg

solenoid benelux Φ b. v.

Stationstraat 34
B-3070 KORTENBERG
Tel: +32 2 757-0141, Fax: 1640
e-mail: info@solenoid.be

Brazil

solenoid do brasil Φ ltda.

Avenida Berna 230
04774-020 SAO PAULO
Tel: +55 11 5524-1288, Fax: 5521-4659/9633
e-mail: knbrasil@krausnaimer.com.br

Canada

canadian solenoid Φ inc.

219 Connie Crescent, Unit 13A
CONCORD, Ontario, L4K 1L4
Tel: +1 905 738-1666, Fax: 9327
e-mail: cdnsolenoid@cansol.on.ca

Chile

ASEA BROWN BOVERI S. A.
Vicuña Mackenna 1602, Casilla 3555
SANTIAGO DE CHILE
Tel: +56 2 544-7411, Fax: 7418

Cyprus

ELECTROMATIC CONSTRUCTIONS LTD.
72, Evagoras Pallikarides Str., CY-2235 LATSIA-Nicosia
P. O. Box 12630, CY-2251 LATSIA-Nicosia
Tel: +357 2 48 41 41, Fax: 48 57 47

Czech Republic

OBZOR, výrobní družstvo Zlín
Louky-Slanica 378
CZ-76413 ZLÍN
Tel: +420 57 7195-111/153 (Techn. Supp.)
Fax: +420 57 7195-152/138
e-mail: ots@obzor.cz

Denmark

C. THIIIM A/S Ingeniørfirma
Transformervej 31
DK-2730 HERLEV
Tel: +45 44 85 80 00, Fax: 80 05
e-mail: thiim@thiim.com

Finland

suomen solenoid Φ oy

Karitie 7
FIN-01530 VANTAA
Tel: +358 9 825-4240, Fax: 42410
e-mail: etunimi.sukunimi@finsol.fi

France

solenoid france Φ s. a.

33, rue Bobillot
F-75013 PARIS
Tél: +33 1 58 40 80 80, Fax: 45 80 91 19
e-mail: sales@solfrance.fr

Germany

deutsche solenoid Φ vertriebs-gmbh

Wikingerstraße 20-28, D-76189 KARLSRUHE
Postfach 10 01 24, D-76231 KARLSRUHE
Tel: +49 721 59 88-0, Fax: 59 28 28
e-mail: desol@krausnaimer.com

Great Britain

u. k. solenoid Φ ltd.

115 London Road
NEWBURY/BERKSHIRE RG14 2AH
Tel: +44 1635 45991, Fax: 37807
e-mail: sales@uksol.co.uk

Greece

KALAMARAKIS-SAPOUNAS S. A.
Ionias & Neromilou Str., P. O. Box 46566
GR-13671 ACHARNES/ATHENS
Tel: +30 2 10 240-6000-6, Fax: 240-6007
e-mail: ksa@ksa.gr

Hungary

GANZ, Schalter- u. Gerätefabrik
X. Kőbányai út 41/c, Postfach 87
H-1475 BUDAPEST
Tel: +36 1 261-5479, Fax: 4685
e-mail: ganzkk@ganzkk.hu

Iceland

BRAEDURNIR ORMSSON EHF
Lágmúli 6-9, P. O. Box 8670
REYKJAVIK
Tel: +354 530-28 00, Fax: 28 10
e-mail: skuli@ormsson.is

Iran

RBS technische und kommerzielle
Beratungsgesellschaft mbH
Kohlriege 14
D-33758 SCHLOSS HOLTE
Tel: +49 5207 9111-0, Fax: 9111-19
e-mail: kontakt@rbs-gmbh.de

Republic of Ireland

irish solenoid Φ ltd.

Bay 145, Shannon Free Zone
SHANNON, Co. Clare
Tel: +353 61 704700, Fax: 471084
e-mail: salesirs@krausnaimer.ie

Italy

solenoid italia Φ s.r.l.

Via Terracini, 9
I-24047 TREVIGLIO (BG)
Tel: +39 0363-30 11 12, Fax: 30 21 13

Japan

solenoid japan Φ co. ltd.

Yoshiwada Building 2F
1-11-6 Hamamatsucho
Minato-Ku, TOKYO 105-0013
Tel: +81 3 3436-6151, Fax: 6325

Kuwait

AMMAR & PARTNERS ELECTRICAL CO.
P. O. Box 1871
13019 SAFAT
Tel: +965 483-0122/483-0133
Fax: +965 484-1818

Malaysia

INDUSTRIAL AUTOMATION (M) Sdn Bhd
30-3 & 30-4 Loke New Road
55200 KUALA LUMPUR
Tel: +60 3-9-2210511, Fax: 2222299
e-mail: inquiry@iasb.com.my

Mexico

ING. JAVIER CABALLERO B.
A. Gaviño 30, Satélite,
53100, Edo. de Mexico, MEXICO
Tel: +52 5555 62-7577, Fax: 0434
e-mail: j_caballero_b@infosol.net.mx

Netherlands

solenoid benelux Φ b. v.

Wegtersweg 38, Postbus 199
NL-7556 BR HENGEL (Ov.)
Tel: +31 74 291-9441, Fax: 8380
e-mail: info@solenoid.nl

New Zealand

new zealand solenoid Φ co. ltd.

42 Miramar Avenue, P. O. Box 15-009
WELLINGTON
Tel: +64 4 380-9888, Fax: 9877
e-mail: sales@nzsolenoid.co.nz

Norway

norsk solenoid Φ a/s

Hjalmar Brantings vei 8, P. O. Box 21, Økern
N-0508 OSLO
Tel: +47 22 64 44 20, Fax: 65 39 49
e-mail: nos@norsksol.no

Poland

ASTAT sp. z o.o.
ul. Dąbrowskiego 461
PL-60451 POZNAŃ
Tel: +48 61 848-8871/72, Fax: 8276
e-mail: info@astat.com.pl

Portugal

ELECTRICOL-DAMAS, FERREIRA & DAMASCENO, S. A.
Apartado 1083
P-2671-852 SANTO ANTÓNIO DOS CAVALEIROS
Tel: +351 21 989-8939, Fax: 988-6464

Kingdom of Saudi-Arabia

HAWA ELECTRIC PANEL BOARD FACTORY
Industrial Area, P. O. Box 1684
DAMMAM 31441
Tel: +966 3 847-2061, Fax: 2056

Singapore

solenoid singapore Φ pte. ltd.

115A, Commonwealth Drive
03-17/23
SINGAPORE 149 596
Tel: +65 6473-8166, Fax: 8643
e-mail: krausnaimer@singsol.com.sg

Slovenia

SCHRACK Energietechnik d.o.o.
Glavni trg 47
SI-2380 SLOVENJ GRADEC
Tel: +386 2 88 392 00, Fax: 434 71
e-mail: schrack.sg@schrack-energietechnik.si

Republic of South Africa

south african solenoid Φ co. pty. ltd.

7 Village Crescent, Linbro Village
Linbro Business Park, SANDTON 2065
P. O. Box 511, KELVIN 2054
Tel: +27 11 608-6060, Fax: 608-2874
e-mail: sales@sasolenoid.co.za

Spain

HAZEMEYER ESPAÑOLA S. A.
Cta. de Tiana s/n, Esq. N-2
BADALONA-BARCELONA
Tel: +34 93 389-4262, Fax: 384-3586
e-mail: heshaze@catworld.net

Sweden

skandinaviska solenoid Φ ab

Dr. Widerströms Gata 11, FRUÅNGEN
Box 42097, S-126 14 STOCKHOLM
Tel: +46 8 97 00 80, Fax: 97 87 33
e-mail: order@skansol.se

Switzerland

AWAG Elektrotechnik AG
Sandbühlstraße 2, Postfach
CH-8604 VOLKETSCHWIL
Tel: +41 1 908-1919, Fax: 1999
e-mail: info@awag.ch

Taiwan

NUWTEC ENTERPRISE Co Ltd
No. 301, Sec. 1, Nan Kang Road
TAIPEI 115, Taiwan, R. o. C.
Tel: +886 2 265-13279, Fax: 13264
e-mail: nathan.nuwtec@msa.hinet.net

Turkey

ÜNAL KARDEŞ ELEKTRİK GEREÇLERİ A. Ş.
Beşyol, Eski Londra Asfaltı-6
TR-34630 SEFAKÖY-İstanbul
Tel: +90 212 624-9204, Fax: 592-4810
e-mail: info@unalkardes.com.tr

USA

american solenoid Φ co. inc.

760 New Brunswick Road, P. O. Box 430
SOMERSET, NJ 08873
Tel: +1 732 560-1240, Fax: 8823
e-mail: amsol@krausnaimer-us.com

