

Catalog 150

KG Switches 20 A-315 A

KH and KHR Switches 16 A-80 A



KRAUS & NAIMER

The development of the Blue Line rotary switch, contactor and motor starter product ranges is based on more than seventy-five years experience by Kraus & Naimer in the design and manufacture of electrical switchgear. Kraus & Naimer pioneered the introduction of the cam operated rotary switch and continues to be recognized as the world leader in that product field.

BLUE LINE

Blue Line products are protected by numerous patents throughout the industrial world. They are built to national and international standards and designed to withstand adverse temperatures and climates.

Blue Line products are accepted and universally recognized for their quality and workmanship. They are supported by a worldwide sales and service organization.

The Kraus & Naimer Registered Trademark



WORLDWIDE SYMBOL
FOR QUALITY SWITCHGEAR

Disconnectors and Main Switches acc. to IEC 60947-3 see Catalog 500

Contents	KG Switches	KH, KHR Switches
	Page	Page
Construction Data	2	23
Nominal Ratings	3	23
How to order	4, 5	4, 5
Types of Mounting and Enclosures	6-8	24, 25
Switch Function and Configuration	9-11	25
Escutcheon Plates	12	26
Handles	13	27
Optional Extras		
Shaft Extensions	16	29
Auxiliary Contacts	14	28, 29
Protective Covers	14	28
Ground and Neutral Terminals	15	29
Padlock Devices	18	32
Door Clutches	16, 17	30, 31
Additional Main Contacts	15	
Additional Module for Motor Control Center (MCC)	19	
Angular drive	19	
Technical Data	20, 21	34, 35
International Standards and Approvals	22	33
Dimensions		
Types of Mounting and Enclosures	36-40	46, 47, 49
Optional Extras	40-45	48-51
Blue Line Switchgear: Summary		52

Disconnectors and Main Switches according to IEC 60947-3 see Catalog 500

The KG10A through KG317 switch line offers excellent performance characteristics and exceed the requirements of IEC 60947-3 as well as the new VDE 0660 part 107. KG switches are principally used as motor and industrial panel disconnectors, double-throw transfer switches, safety switches, main disconnect switches and distribution system isolation switches. This durable switch line possesses high short-circuit withstand capabilities, with positive contact movement during making and breaking functions. KG switches exhibit excellent AC-3 and AC-23 making and breaking capabilities providing an additional safety advantage.

The safety level of the KG switch series in numerous areas surpasses those of many international standards organizations: Positive contact movement during making and breaking operations. Higher dimensioned air and creepage distances for 690 V or 1000 V. Dead front, finger-proof box terminals according to EN 50274, VDE 0660 part 514 and BGV A2. Switch types KG210, KG250 and KG315 require an option protective cover.







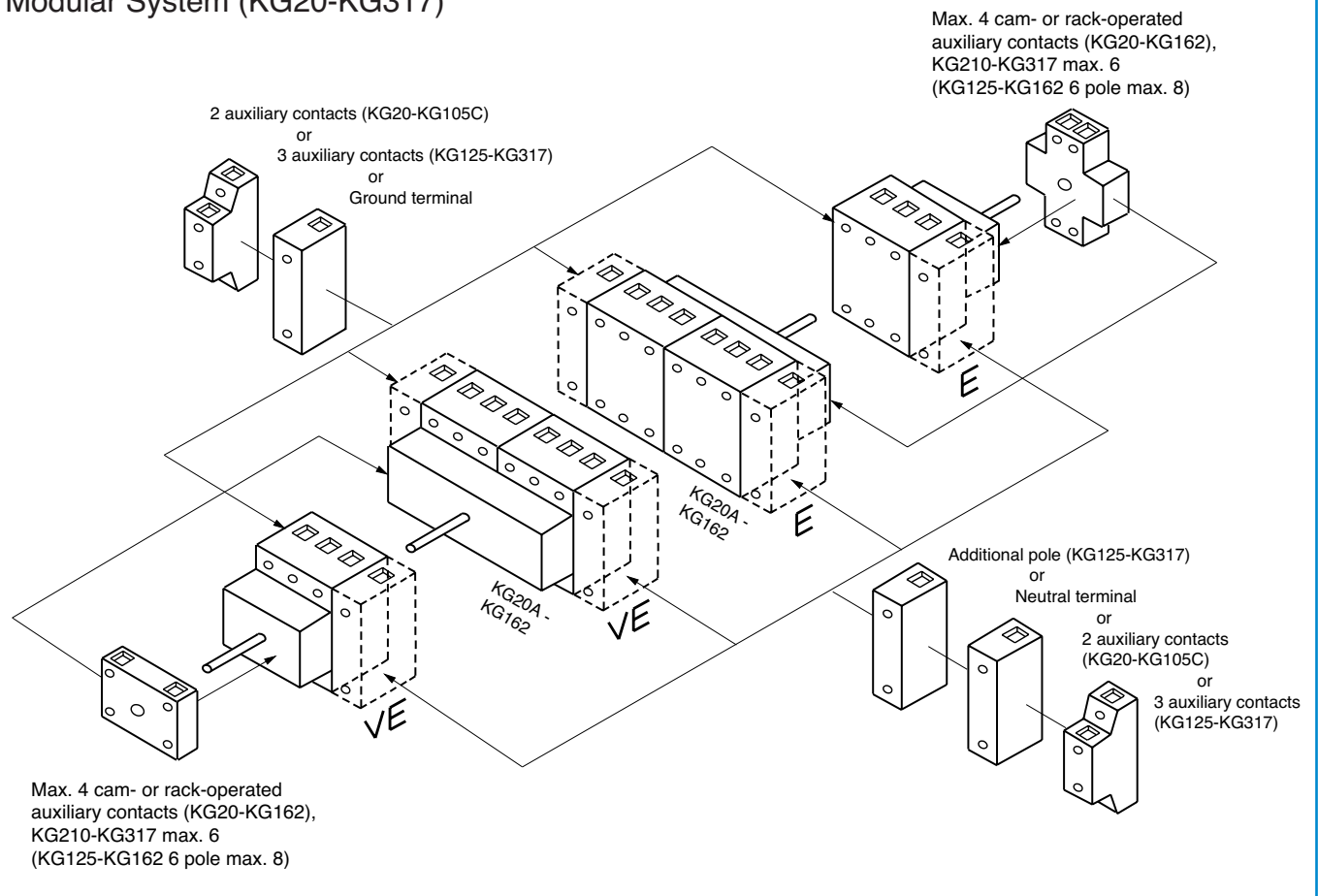





This advanced switch-generation affords significant advantages during mounting and wiring. For ease of installation, switch terminals are on the same plane as the power conductors. The KG10A through KG105C base mounted switches feature a two hole mounting as well as a "quick mount" designed for standard DIN rails according to EN 50022. KG125 through KG317 feature a four hole mounting.

The flexibility of the KG's modular system offers maximum versatility for the modifying of switches in the field. Modules can easily be added to switches which have already been installed in equipment often without having to remove existing wiring. This modular design also minimizes the need for high inventory levels. Other important accessories such as make before break auxiliary contacts, additional box and bolt terminals, shaft extensions, door clutches, terminal covers and padlock devices enhance the flexibility and versatility of this proven line of switches.

Modular System (KG20-KG317)



Nominal Ratings

Escutcheon Plate Frame mm		Typen	IEC 60947-3/VDE 0660 part 107			UL and Canada	
			Rated Values			Standard Motor Load	
			Thermal Current I_u/I_{th} A	Utilization Category AC-23A kW	AC-3 V-440 V A	Ampere-Rating 3 x 600 V A	DOL-Rating 3 x 240 V HP
48 x 48	64 x 64	 KG10A					
		 KG10B					
		KG10A KG10B	20 20	5,5 5,5	3,7 3,7	20 20	2 3
30 x 30	48 x 48	 KG20 KG32					
		 KG20A KG32A					
		 KG20B KG32B					
		KG20 KG20A KG20B	25 25 25	7,5 7,5 7,5	5,5 5,5 5,5	25 25 25	3 3 3
		KG32 KG32A KG32B	32 32 32	11 11 11	7,5 7,5 7,5	30 30 30	5 5 5
48 x 48	64 x 64	 KG41 KG64					
		 KG41B KG64B					
		KG41 KG41B	40 40	15 15	11 11	40 40	7,5 7,5
		KG64 KG64B	63 63	22 22	18,5 18,5	60 60	10 10
64 x 64	88 x 88	 KG80 KG100 KG105					
		 KG80C KG100C KG105C					
		KG80 KG100 KG105	80 80	30 30	22 22	80 ¹ 80 ¹	20 20
		KG80C KG100C KG105C	100 100	37 37	30 30	100 ¹ 100 ¹	25 25
		KG105 KG105C	125 125	45 45	37 37		in preparation
88 x 88	88 x 88	 KG125, KG160 KG210, KG250, KG315 (with box terminals)					
		 KG126, KG161 KG211, KG251, KG316 (with bolt terminals)					
		KG125 KG126 KG127	125 125 125	45 45 45	37 37 37	150 ¹ 150 ¹ 150 ¹	30 30 30
		KG160 KG161 KG162	160 160 160	55 55 55	45 45 45	200 ¹ 200 ¹ 200 ¹	40 40 40
		KG210 KG211 KG212	200 200 200	75 75 75	55 55 55	200 ¹ 200 ¹ 200 ¹	50 50 50
88 x 88		 KG250, KG252 KG315, KG316, KG317 (bolt terminals on top, box terminals at the bottom)					
		KG250 KG251 KG252	250 250 250	90 90 90	55 55 55	250 ¹ 250 ¹ 250 ¹	60 60 60
		KG315 KG316 KG317	315 315 315	110 110 110	75 75 75	300 ¹ 300 ¹ 300 ¹	75 75 75

¹Valid when connected with wire rated for 75 °C.

How to order

Disconnectors and Main Switches according to IEC 60947-3 see Catalog 500

Three or four pieces of data (shown below) are required for ordering Blue Line Switch Disconnectors. Code numbers for ordering are shown in this catalog.

1. Type of Switch

The type of switch required may be easily selected by referring to the tables on pages 3 and 23 which show the thermal current and power rating of each switch. For further technical details, refer to pages 20/21 and 34/35.

2. Switch Function

The code numbers for the KG switches shown on pages 9-11 and on page 25 for the KH switches indicate the switch function, escutcheon plates and handles. Additional coding to modify the type and color of handle and escutcheon plate is explained below and on page 5.

3. Type of Mounting

Switch types and enclosures for the KG switches are shown on pages 6-8. The KH switches may be selected by referring to the table on page 24.

KG100

**K302-600
M004**

VE

4. Optional Extras

Pages 14-19 list optional extras and their coding for the KG switches. For the KH/KHR switches refer to pages 28-32. A table shows the different switch sizes in which the optional extra is available.

There are some optional extras which are available in a variety of programs. Additional ordering data may, therefore, be required.

Modification of Switches

The part number or switch function and options may be modified in cases where items are required other than standard. The modification may involve the escutcheon plate inscription, color combination of escutcheon plate and handle, type of escutcheon plate and handle, or the optional extra.

Color combination of escutcheon plate and handle for KG and KH/KHR switches

Switch Type	Escutcheon Plate Frame	Handle	Escutcheon Plate Backing	Escutcheon Plate Lettering	Dash-number
KG ¹ , KH/KHR	electro-gray	electro-gray	brushed alu	black	-100
KG ¹ , KH/KHR	electro-gray	electro-gray	black	mat silver	-500
KG, KH/KHR	black	black	brushed alu	black	-600
KG, KH/KHR	black	black	black	mat silver	-700

¹Not available for switch types KG20 and KG32.

How to order

Modification of Switches

Color combinations of escutcheon plate and handle for KG and KH/KHR switches

The standard switch consists of a transparent escutcheon plate with brushed aluminum backing and black inscription. The escutcheon plate frame is black and it has a black handle. Pages 4, 12 and 26 show further combinations which are available. The subcoding shown on this page should be specified when color combinations are required.

Example: The complete coding for switch type KG100 with a 3 pole ON/OFF switch function, electro-gray handle and electro-gray escutcheon plate frame with brushed aluminum backing and black inscription which reads **0-1** is as follows: **KG100 K300-100 E**.

The following is a list of special programs for escutcheon plate and handle combinations. They may be obtained by specifying any one of the corresponding two digit dash-numbers as a part of the dash-number. It is necessary to prefix these two numbers with a digit number which represents the color combination required.

Special programs for plate and handle combinations for KG and KH/KHR switches

- **000** = without escutcheon plate, without handle
- **.01** = without escutcheon plate
- **.02** = without handle
- **.03** = with square escutcheon plate without lettering
- **.04** = with rectangular escutcheon plate without lettering
- **.05** = with square escutcheon plate without lettering and without handle
- **.06** = with rectangular escutcheon plate without lettering and without handle
- **.07** = standard escutcheon plate, without lettering on rectangular section
- **.08** = with F-handle
- **.09** = with P-handle
- **.10** = escutcheon plate with frame and fixation ring only (if using switches with single hole mounting: - **.16**)
- **.11** = without escutcheon plate, but with handle bearing plate
- **.12** = with yellow escutcheon plate backing and red handle
- **.14** = with B-handle
- **.16** = escutcheon plate with frame and fixation ring only if using switches with single hole mounting

Example: The complete coding for switch type KG100C with a 3 pole ON/OFF switch function with electro-gray escutcheon plate frame, square escutcheon plate without lettering, brushed aluminum plate backing and electro-gray handle reads as follows: **KG100C K300-103 VE**.

Handles, Escutcheon Plates and Optional Extras

Various standards for the KG switches are listed in the table on pages 6-8 and for the KH/KHR switches on page 24.

When a handle, escutcheon plate or optional extra is required but not covered by the dash-number, the code number for the selected component should be entered separately. A complete range of standard escutcheon plates are illustrated on pages 12/13 and 26/27. Non standard or special escutcheon plate engravings are available at extra cost.





Ordering of Special Escutcheon Plates

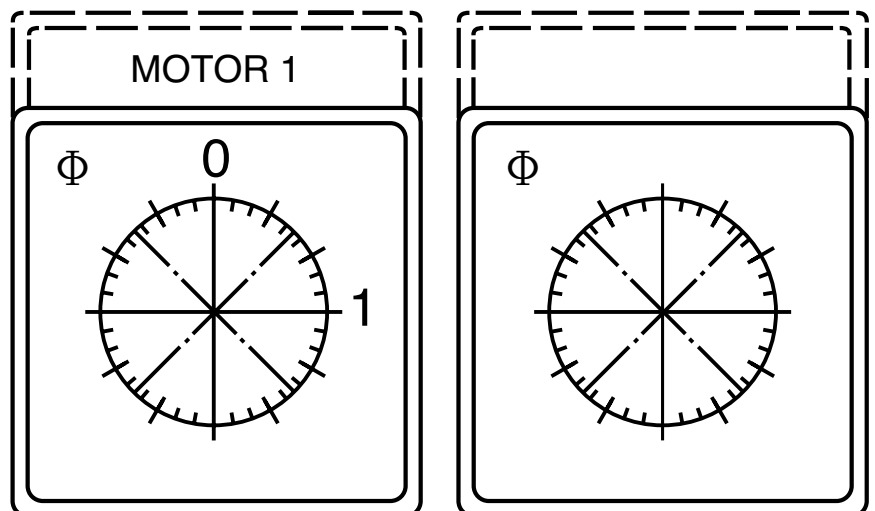

When ordering special escutcheon plates it is advisable to use our order form, as illustrated.

Example: Customer's requirements are shown beside.

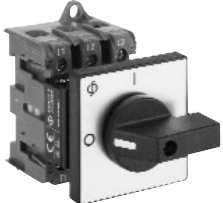

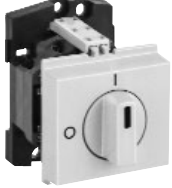



Order forms are available upon request.

Mounting	Type	Code
	<p>Front mounting protection IP 65</p> <p>Two hole panel mounting</p> <p>Four hole panel mounting</p>	<p>KG20 KG32</p> <p>KG10A- KG317</p> <p>E</p> <p>E</p>
	<p>Single hole mounting 22 mm Protection IP 65</p> <p>Without escutcheon plate</p>	<p>KG10A KG20A KG32A</p> <p>FT1</p>
	<p>With square escutcheon plate</p>	<p>KG10A KG20A KG32A</p> <p>FT2</p>
	<p>Base mounting</p> <p>Screw/Snap-on base mounting for track EN 50022, protection IP 40</p> <p>Snap-on base mounting for track EN 50022, protection IP 40</p>	<p>KG10A- KG317</p> <p>KG125- KG162</p> <p>VE</p> <p>VE1</p>
	<p>Screw/Snap-on base mounting for track EN 50022. Escutcheon plate for 45 mm knock-out.</p>	<p>KG20A KG32A KG41- KG64B KG80- KG105 KG125- KG162</p> <p>VE2</p>
	<p>Snap-on base mounting for track EN 50022. Both the escutcheon plate for 45 mm standard knock-out and the handle are adjustable in height.</p>	<p>KG10A</p> <p>VE21</p>

Plastic Enclosure Protection IP 66/67	Type	Code
	<p>The KL and CL enclosures are available in 3 sizes allowing for installation of 3, 4 and 6 pole KG switches. The KL-series is made of strong durable plastic and offers high UV-resistance. The CL-series is especially designed for applications in an aggressive environment, such as oil, chemical substances and grease. Each enclosure has 2 knock-outs on top and bottom for metric thread according to EN 50262. Included in each enclosure is a ground and neutral terminal. One of these terminals must be eliminated if a 3 pole switch with lateral mounted auxiliary contacts or a 4 pole switch is installed.</p> <p>All enclosures can be supplied with a cover coupling for additional safety. Increased wiring space and mounting holes with slots are featured in this new line. These enclosures are also available for conduit entries for PG-thread.</p>	<p>KG20 KG32 KG20B KG32B KG41 KG64 KG41B KG64B KG80 KG100 KG105</p>
	<p>Without cover interlock</p>	<p>KL.0 CL.0</p>
	<p>With cover interlock (The enclosure can only be opened at 9 o'clock position)</p>	<p>KL.1 CL.1</p>
	<p>With cover interlock (The enclosure can only be opened at 12 o'clock position)</p>	<p>KL.2 CL.2</p>
	<p>KS and CS enclosures have a compact size which allows for the installation of a 3, 4 or 6 pole KG10 ON/OFF switch or a 3 pole KG20 ON/OFF switch. The design, options and mounting are the same as those of the KL and CL enclosures.</p>	<p>KG10 KG20</p>
	<p>Without cover interlock</p>	<p>KS50 CS50</p>
	<p>With cover interlock (The enclosure can only be opened at 9 o'clock position)</p>	<p>KS51 CS51</p>
	<p>With cover interlock (The enclosure can only be opened at 12 o'clock position)</p>	<p>KS52 CS52</p>

Plastic Enclosure with Ground Terminal Protection IP 65 resp. IP 54	Threads	Type	Code
---	---------	------	------















 <p>KG20A, KG32A, KG41, KG64 3 and 4 pole (ON/OFF Switches) Protection IP 65</p>	Conduit entries with NPT-thread		KG20A KG32A KG41 KG64	
	Without cover coupling	1/2" 3/4"		PFA4 PFA
	And for switches with cam-operated auxiliary contacts	1/2" 3/4"		PFD4 PFD
	With cover coupling	1/2" 3/4"		PFB4 PFB
 <p>KG80, KG100 3 and 4 pole¹ (ON/OFF Switches) KG20B, KG32B, KG41B, KG64B 6 pole (ON/OFF Switches) 3 and 4 pole (Double-throw Switches) Protection IP 54 On top and at the bottom an additional conduit entry .63"</p>	And for switches with cam-operated auxiliary contacts	1/2" 3/4"		PFE4 PFE
	Without cover coupling, combined with padlock device V840A	1/2" 3/4"		PFC4 PFC
	And for switches with cam-operated auxiliary contacts	1/2" 3/4"		PFF4 PFF
			KG20B KG32B KG41B KG64B KG80 KG100	
 <p>KG80, KG100 3 and 4 pole¹ (ON/OFF Switches) KG20B, KG32B, KG41B, KG64B 6 pole (ON/OFF Switches) 3 and 4 pole (Double-throw Switches) Protection IP 54 On top and at the bottom an additional conduit entry .63"</p>	Without cover coupling	3/4" 1"		PFA5 PFA
	And for switches with cam-operated auxiliary contacts	3/4" 1"		PFD5 PFD
	With cover coupling	3/4" 1"		PFB5 PFB
	And for switches with cam-operated auxiliary contacts	3/4" 1"		PFE5 PFE
 <p>KG80, KG100 3 and 4 pole¹ (ON/OFF Switches) KG20B, KG32B, KG41B, KG64B 6 pole (ON/OFF Switches) 3 and 4 pole (Double-throw Switches) Protection IP 54 On top and at the bottom an additional conduit entry .63"</p>	Without cover coupling, combined with padlock device V840A	3/4" 1"		PFC5 PFC
	And for switches with cam-operated auxiliary contacts	3/4" 1"		PFF5 PFF
	These enclosures are also available with PG-, BSI- or metric ISO-thread on request.			

¹For switches with cam-operated auxiliary contacts only 3 pole.

Function	KG10A	KG10B	KG20 KG32	KG20A KG32A	KG20B KG32B	KG41 KG64	KG41B KG64B	KG80 KG100 KG105	KG80C KG100C KG105C	KG125- KG317	Escutch. Plate	Code
----------	-------	-------	--------------	----------------	----------------	--------------	----------------	------------------------	---------------------------	-----------------	-------------------	------

ON/OFF Switches 3 pole

Types of Mounting









Without auxiliary contacts	E	E	E	E	E	E	E	E	E	E		K300-600
	FT1 FT2 VE VE21 KS. ²	VE	VE	FT1 FT2 VE VE2 PF..	VE	VE VE2 KL. PF..	VE VE2 KL. PF..	VE VE2 KL. PF.. ⁴	VE	VE VE1 ³ VE2 ³		K300-620
With cam/rack-operated auxiliary contact 1 NO	E	E	E	E	E		E	E	E	E		K301-600
	FT1 FT2 VE VE21 KS. ²	VE	VE	FT1 FT2 VE VE2 PF..	VE	KL. PF..	KL. PF.. ⁴	VE VE1 ³		K301-620		
With cam/rack-operated auxiliary contacts 1 NO and 1 NC	E	E	E	E	E		E	E	E	E		K302-600
	FT1 FT2 VE VE21 KS. ²	VE	VE	FT1 FT2 VE VE2 PF..	VE	KL. PF..	KL. PF.. ⁴	VE VE1 ³		K302-620		
With cam/rack-operated auxiliary contacts 2 NO			E	E	E		E	E	E	E		K312-600
			VE KL. PF..	FT1 FT2 VE VE2 PF..	VE	KL. PF..	KL. PF.. ⁴	VE VE1 ³		K312-620		
With lateral mounted auxiliary contacts 1 NO and 1 NC			E	E	E	E	E	E	E			K304-600
			VE KL. PF..	FT1 FT2 VE VE2 PF..	VE	KL. PF..	KL. PF.. ⁴	VE			K304-620	
With GRD-terminal			E	E	E	E	E	E	E	E		K305-600
			VE	FT1 FT2 VE VE2	VE	VE VE2	VE VE2	VE VE2	VE	VE VE1 ³ VE2 ³		K305-620
With GRD- and N-terminal			E	E	E	E	E	E	E	E		K307-600
			VE	FT1 FT2 VE VE2	VE	VE VE2	VE VE2	VE VE2	VE	VE VE1 ³ VE2 ³		K307-620

¹Only for switch type KG20. ²When using KS. the switch type changes to KG10. ³Only for switch types KG125-KG162. ⁴Only for switch types KG80 and KG100.

Function	KG10A	KG10B	KG20 KG32	KG20A KG32A	KG20B KG32B	KG41 KG64	KG41B KG64B	KG80 KG100 KG105	KG80C KG100C KG105C	KG125- KG317	Escutch. Plate	Code
----------	-------	-------	--------------	----------------	----------------	--------------	----------------	------------------------	---------------------------	-----------------	-------------------	------

ON/OFF Switches 4 pole

Types of Mounting







Without auxiliary contacts	E	E	E	E	E	E	E	E	E	E		K400-600
	FT1 FT2 VE VE21 KS. ¹	VE	VE	FT1 FT2 VE VE2 PF..	VE	VE VE2 KL. PF..	VE VE2 KL. PF..	VE VE2 KL. PF.. ³	VE VE2 KL.	VE VE1 ² VE2 ²		K400-620
With cam-operated auxiliary contact 1 NO			E	E	E		E	E	E	E		K401-600
			VE KL.	FT1 FT2 VE VE2 PF..	VE	VE VE2 KL. PF..	VE KL.	VE KL.	VE VE1 ²			K401-620
With cam-operated auxiliary contacts 1 NO and 1 NC	E	E	E	E	E		E	E	E	E		K402-600
	FT1 FT2 VE VE21 KS. ¹	VE	VE	FT1 FT2 VE VE2 PF..	VE	VE VE2 KL. PF..	VE KL.	VE KL.	VE VE1 ²			K402-620
With lateral mounted auxiliary contacts 1 NO and 1 NC			E	E	E	E	E	E	E			K404-600
			VE	FT1 FT2 VE VE2 PF..	VE	VE VE2	VE VE2 PF.. ³	VE				K404-620

¹When using KS. the switch type changes to KG10. ²Only for switch types KG125-KG162. ³Only for switch types KG80 and KG100.



Function	KG10A	KG10B	KG20A KG32A	KG20B KG32B	KG41B KG64B	KG80 KG100 KG105	KG80C KG100C KG105C	KG125- KG162	Escutch. Plate	Code
----------	-------	-------	----------------	----------------	----------------	------------------------	---------------------------	-----------------	-------------------	------

ON/OFF Switches 6 pole



Types of Mounting

Without auxiliary contacts	E FT1 FT2 VE VE21	E VE	E VE VE2	E VE KL. PF..	E VE VE2 KL. PF..	E VE VE2	E VE	E VE VE1		K600-600
	KS. ¹									K600-620
With cam-operated auxiliary contact 1 NO			E VE VE2	E VE KL. PF..	E VE VE2 KL. PF..	E VE	E VE	E VE VE1		K601-600
										K601-620
With cam-operated auxiliary contacts 1 NO and 1 NC	E FT1 FT2 VE VE21	E VE	E VE VE2	E VE KL. PF..	E VE VE2 KL. PF..	E VE VE2	E VE	E VE VE1		K602-600
	KS. ¹									K602-620

Double-throw Switches 3 pole

Without auxiliary contacts			E VE VE2	E VE KL. PF..	E VE VE2 KL. PF..	E VE VE2	E VE	E VE VE1		K900-600
										K900-620

Double-throw Switches 4 pole

Without auxiliary contacts			E VE VE2	E VE KL. PF..	E VE VE2 KL. PF..	E VE VE2	E VE	E VE VE1		K950-600
										K950-620

Connection Diagrams

ON/OFF Switches 3 pole (with cam-operated auxiliary contacts)

With lateral mounted auxiliary contacts

Mounting E, FT1, FT2 VE, VE2, KL., PF..

With GRD-terminal

With GRD- and N-terminal

ON/OFF Switches 4 pole (with cam-operated auxiliary contacts)

With lateral mounted auxiliary contacts

Mounting E, FT1, FT2 VE, VE2

ON/OFF Switches 6 pole (with cam-operated auxiliary contacts)

Double-throw Switches 3 pole

Double-throw Switches 4 pole

¹When using KS. the switch type changes to KG10.

Square and rectangular escutcheon plates are available for each size of switch. The escutcheon plate consists of a frame and a faceplate having the switch position which is than embossed with hot-foil backing. The escutcheon plate frame is an essential part of the switch and serves as a bearing surface for the handle. If the switch is to be mounted without an escutcheon plate we would recommend the handle bearing plate T100-04, which is available for switch types KG10B, KG20B, KG32B, KG41B, KG80, KG100, KG105, KG80C, KG100C, KG105C and KG125-KG317. Escutcheon plates with special lettering are also available upon request.

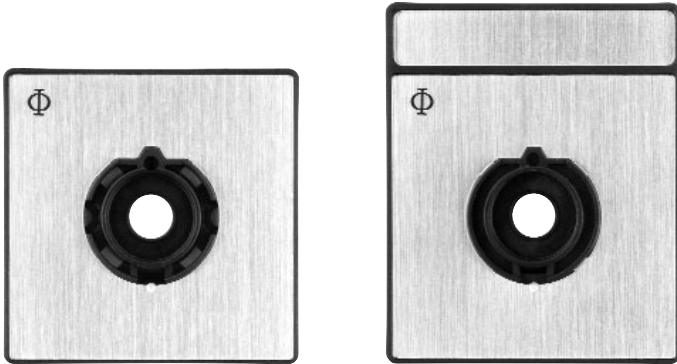

Escutcheon plate frame and faceplate can be obtained in different colors as listed below and defined in the first digit of the dash-number (1, 5, 6, 7):

Switch Type	Escutcheon Plate Frame	Handle	Escutcheon Plate Backing	Escutcheon Plate Lettering	Dash-number
KG10A ¹ -KG317	electro-gray	electro-gray	brushed alu	black	-100
KG10A ¹ -KG317	electro-gray	electro-gray	black	mat silver	-500
KG10A-KG317	black	black	brushed alu	black	-600
KG10A-KG317	black	black	black	mat silver	-700



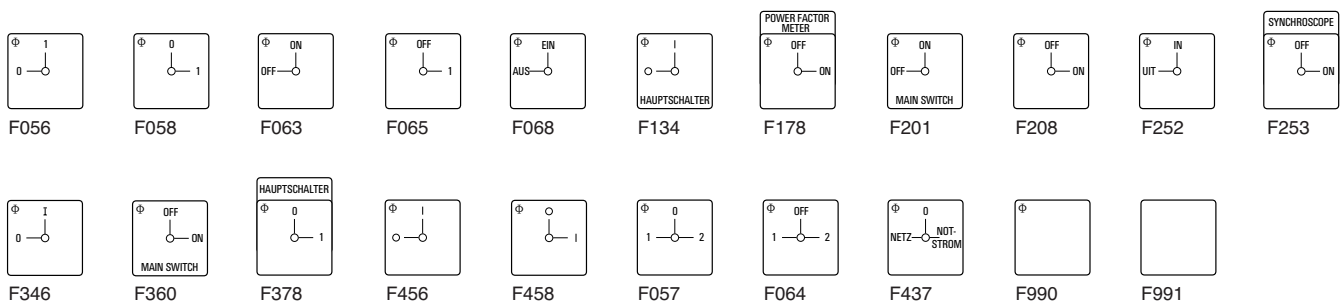



Standard Escutcheon Plates



¹Not available for switch types KG20 and KG32.

Handles

KG Switches



Type	Color	Code	KG20 KG32	KG10A- KG64	KG10B- KG105	KG80C- KG105C	KG125- KG162	KG210- KG317
I-Handle 	black red white electro gray	G251 G252 G253 G257	● ● ● ●	● ● ● ●	● ● ● ●	● ● ● ●	● ● ● ●	— — — —
B-Handle 	black red white electro-gray	G521 G522 G523 G527	— — — —	● ● ● ●	● ● ● ●	— — — —	— — — —	— — — —
R-Handle 	black red white electro-gray	G001 G002 G003 G007	— — — —	● ● ● ●	● ● ● ●	● ● ● ●	● ● ● ●	— — — —
F-Handle 	black red white electro-gray	G221 G222 G223 G227	● ● — —	● ● ● ●	● ● ● ●	● ● ● ●	● ● ● ●	— — — —
L-Handle 	black red white electro-gray	G501 G502 G503 G507	— — — —	— — — —	● ● ● ●	— — — —	— — — —	— — — —
P-Handle  KG10A-KG64 KG10B-KG317	black red white electro-gray	G211 G212 G213 G217	— — — —	● ● ● ●	● ● ● ●	● ● ● ●	● ● ● ●	● ● ● ●
K-Handle 	black red white electro-gray	G411 G412 G413 G417	— — — —	— — — —	● ● ● ●	● ● ● ●	● ● ● ●	● ● ● ●

Protective Covers, Auxiliary Contacts	Type	Code
--	------	------

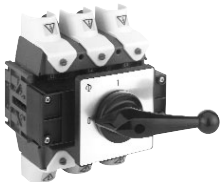

Protective Covers

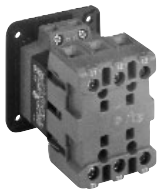



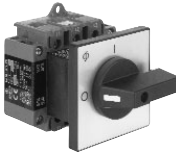

	For 3 resp. 4 main contacts	KG10A	M160/A12 K2
	For 3 main contacts with box terminal	KG10B	
	with bolt terminal	KG20- KG315	M160/3.
		KG126	M160/33
		KG161	M160/31
		KG211	M160/31
		KG251	M160/31
		KG316	M160/31
	For 4 main contacts with box terminal	KG20- KG315	M160/4.
	with bolt terminal	KG126	M160/43
		KG161	M160/41
		KG211	M160/41
		KG251	M160/41
		KG316	M160/41

Cam- and rack-operated Auxiliary Contacts (mounting only at factory)

	Cam-operated auxiliary contacts Up to 4 cam-operated auxiliary contacts can be added to all switches.	KG20- KG105C	M510A
	Select between a contact system with a rigid contact bridge for excellent AC-15 making and breaking capabilities or a H-bridge design with "cross-wire" contacts for low voltages and currents (mounting E from KG41 and mounting VE from KG80). The contact systems with gold contacts or gold-plated contacts allow for use in aggressive environments also. Special programs are also available upon request.		
	Rack-operated auxiliary contacts Switch types KG125-KG162 can be supplied with up to 4 auxiliary contacts, KG210-KG317 with up to 6 auxiliary contacts.	KG125- KG317	M510B
	Ordering data:	Quantity and operation of the auxiliary contacts and type of the contact system.	

Lateral mounted Auxiliary Contacts

	Lateral mounted auxiliary contacts with 1 NO and 1 NC.	KG20- KG105C	H010/A11-E H010/A11-VE	
	Standard contacts (nonoverlapping)	Terminal numbers Attachment		
	For mounting E, FT1 and FT2	left (33-34, 41-42) right (53-54, 61-62)		
	For mounting VE, VE2, KL. and PF..	(31-32, 43-44) (51-52, 63-64)		
	Overlapping contacts		H010/B11-E H010/B11-VE	
	For mounting E, FT1 and FT2	(33-34, 41-42) (53-54, 61-62)		
	For mounting VE, VE2, KL. and PF..	(31-32, 43-44) (51-52, 63-64)		
	Lateral mounted auxiliary contacts with 2 NO and 1 NC.	KG125- KG317		H010/A21-E H010/A21-VE
	Standard contacts (nonoverlapping)	Terminal numbers Attachment		
	For mounting E	left (013-014, 023-024, 031-032) right (043-044, 053-054, 061-062)		
	For mounting VE	(011-012, 023-024, 033-034) (041-042, 053-054, 063-064)		
	Overlapping of 1 NO and 1 NC			
For mounting E	(013-014, 023-024, 031-032) (043-044, 053-054, 061-062)			
For mounting VE	(011-012, 023-024, 033-034) (041-042, 053-054, 063-064)			

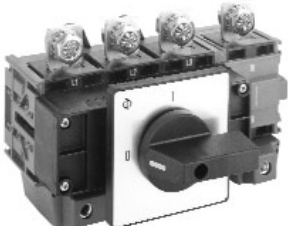
Ground and Neutral Terminals	Type	Code	Additional Main Contacts	Type	Code																
<p>Ground terminal</p>  	KG20- KG32B	K0 H052/A	 <p>Terminals for Control Circuit</p>  <p>Max. Permissible Wire Gage Single-core or Flexible wire stranded wire</p> <table border="1"> <tr> <td>2,5 mm² AWG12</td> <td>2,5 mm² AWG14</td> <td>KG41- KG64B</td> <td>K1B D220 KS</td> </tr> <tr> <td>2,5 mm² AWG12</td> <td>2,5 mm² AWG14</td> <td>KG80- KG105C</td> <td>K2B D520 KSA</td> </tr> <tr> <td>4 mm² AWG10</td> <td>4 mm² AWG12</td> <td>KG125- KG162</td> <td>K3A D720 KS</td> </tr> <tr> <td>4 mm² AWG10</td> <td>4 mm² AWG12</td> <td>KG210- KG317</td> <td>K3B D520 KS</td> </tr> </table> <p>Wiring Aid</p>  <p>Ordering data: Switch mounting.</p>	2,5 mm ² AWG12	2,5 mm ² AWG14	KG41- KG64B	K1B D220 KS	2,5 mm ² AWG12	2,5 mm ² AWG14	KG80- KG105C	K2B D520 KSA	4 mm ² AWG10	4 mm ² AWG12	KG125- KG162	K3A D720 KS	4 mm ² AWG10	4 mm ² AWG12	KG210- KG317	K3B D520 KS	KG125 KG126 KG127	K3 H050/P K3 H050/Q K3 H050/R
	2,5 mm ² AWG12	2,5 mm ² AWG14		KG41- KG64B	K1B D220 KS																
	2,5 mm ² AWG12	2,5 mm ² AWG14		KG80- KG105C	K2B D520 KSA																
	4 mm ² AWG10	4 mm ² AWG12		KG125- KG162	K3A D720 KS																
	4 mm ² AWG10	4 mm ² AWG12		KG210- KG317	K3B D520 KS																
	KG41- KG64B	K1 H052/B		KG160 KG161	K3 H050/S K3 H050/T K3 H050/U																
	KG80- KG105C	K2 H052/C		KG210 KG250 KG315	K3 H050/G K3 H050/H K3 H050/J																
	KG125 KG160	K3 H052/H		KG211 KG251																	
	KG126 KG161	K3 H052/J		KG212 KG252																	
	KG127 KG162	K3 H052/K		KG316 KG317	K3 H050/K K3 H050/L K3 H050/M																
	KG210 KG250 KG315	K3 H052/D																			
	KG211 KG251	K3 H052/E																			
	KG212 KG252	K3 H052/F																			
	KG316 KG317	K3 H052/L K3 H052/M																			
<p>Neutral terminal</p>  	KG20- KG32B	K0 H053/A																			
	KG41- KG64B	K1 H053/B																			
	KG80- KG105C	K2 H053/C																			
	KG125 KG160	K3 H053/H																			
	KG126 KG161	K3 H053/J																			
	KG127 KG162	K3 H053/K																			
	KG210 KG250 KG315	K3 H053/D																			
	KG211 KG251	K3 H053/E																			
	KG212 KG252	K3 H053/F																			
	KG316 KG317	K3 H053/L K3 H053/M																			

Shaft Extensions, Simplified Door Clutch	Type	Code
--	------	------





Shaft Extensions

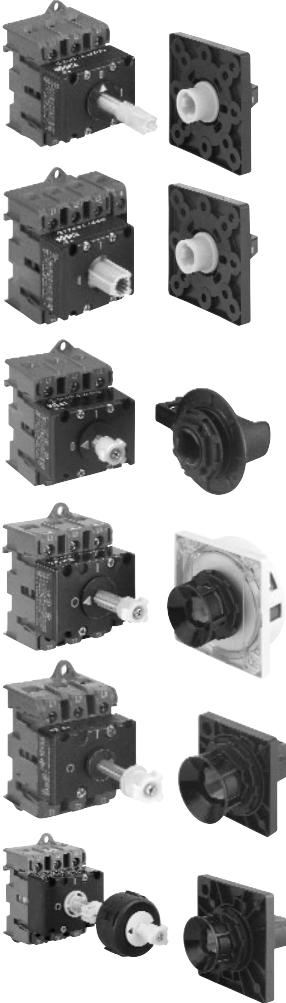

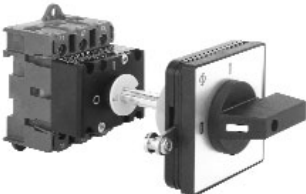
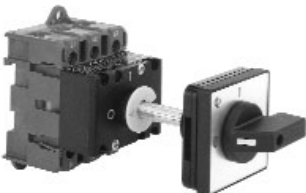

	<p>With asymmetric profile Shaft length not adjustable</p> <p>Shaft with adjustable length with set screw with shear ring</p> <p>With square profile Shaft length not adjustable</p> <p>Shaft with adjustable length with set screw with clamping bushing</p>	<p>KG10B KG20B, KG32B KG41B-KG105C</p> <p>KG10A KG20A, KG32A KG41-KG317</p> <p>KG10B KG20B, KG32B KG41B-KG105C</p> <p>KG41B-KG317 KG125-KG317</p>	<p>L100</p> <p>M004D M004</p> <p>L100A</p> <p>M004E M004A</p>
<p>Ordering data:</p>	<p>Free shaft length or dimension from mounting surface to cover.</p>		

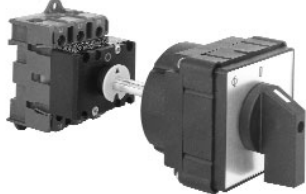



Simplified Door Clutch

	<p>The simplified door clutches are utilized primarily when the switch is mounted to the bottom of the enclosure and the handle and escutcheon plate are mounted on the cover.</p> <p>With shaft extension Front protection IP 40 Front protection IP 65</p> <p>With profile extension parts Front protection IP 65</p> <p>With padlock device, single hole mounting 22 mm, protection IP 65. An additional aluminum shaft extension is required.</p> <p>The cover disc is available in black, yellow and electro-gray. The handle may be supplied in black, red and electro-gray.</p> <p>Operation of the locking bar from the front. Available in black, red and electro-gray.</p> <p>Centering device for simplified door clutches with single hole mounting and shaft extension Misalignment between the shaft and mounting are compensated in all 4 directions.</p>	<p>KG10A KG20A, KG32A KG41B-KG105</p> <p>KG41B-KG105</p> <p>KG10B KG20B, KG32B KG41B-KG105, KG125-KG317²</p> <p>KG10B KG20B, KG32B KG41B-KG105</p> <p>KG10A KG20A, KG32A KG41, KG64 KG10B KG20B, KG32B KG41B-KG105</p> <p>KG10B KG20B, KG32B KG41B-KG105</p>	<p>M290/A3 M290/A3.EF¹</p> <p>M290/A1.EF</p> <p>V840E</p> <p>V840G V840F</p> <p>V845</p> <p>M600</p>
<p>Ordering data:</p>	<p>Free shaft length or dimension from face of the switch to the cover and color selection.</p>		

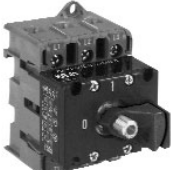
¹Available for switch types KG10A, KG20A and KG32A. ²Only for ON/OFF switches 3 and 4 pole.

Door Clutches	Type	Code																								
    	<p>The M280 door clutch has an adjustable shaft and can be supplied with an interlock device. The following interlock programs are available: A = Without interlock by door clutch B = With interlock by door clutch C = With interlock by rods D = With interlock by door clutch and rods</p> <p>With protected profile shaft fixation with set screw Front protection IP 40 Front protection IP 66/67 (KG10A-KG32A: IP 65) shaft fixation with shear ring Front protection IP 40 Front protection IP 66/67 (KG10A-KG32A: IP 65)</p> <p>Without protected profile Front protection IP 40 Front protection IP 65</p> <p>The M700 is a padlockable door clutch and a mechanical interlocking safety device. Using the device the electrical panel may be opened only when the switch is in the "OFF" position. NOTE: Knowledgeable personnel using a simple tool are able to defeat the interlock. The M700's flexibility allows for successful installation with as much as + or - 5 mm of misalignment between shaft and door.</p> <p>Handle lockable with padlocks Protection IP 65 Selection of escutcheon plate and handle color required:</p> <table border="1" data-bbox="550 1406 1161 1644"> <thead> <tr> <th>Escutcheon Plate</th> <th>Frame Plate</th> <th>Handle</th> <th>Lock Bar</th> </tr> </thead> <tbody> <tr> <td>A = brushed alu</td> <td>black</td> <td>black</td> <td>red</td> </tr> <tr> <td>B = brushed alu</td> <td>black</td> <td>red</td> <td>yellow</td> </tr> <tr> <td>C = brushed black</td> <td>black</td> <td>black</td> <td>red</td> </tr> <tr> <td>D = brushed black</td> <td>black</td> <td>red</td> <td>yellow</td> </tr> <tr> <td>E = yellow</td> <td>black</td> <td>red</td> <td>yellow</td> </tr> </tbody> </table> <p>Standard handle and standard escutcheon plate Protection IP 65</p> <p>Unlock insert for the M700 to open the door in ON position. (After the locking has been made inactive, it is necessary to take effective precautions against an opening of the door by unauthorized persons.)</p>	Escutcheon Plate	Frame Plate	Handle	Lock Bar	A = brushed alu	black	black	red	B = brushed alu	black	red	yellow	C = brushed black	black	black	red	D = brushed black	black	red	yellow	E = yellow	black	red	yellow	<p>KG10A KG20A KG32A KG41B KG64B KG80 KG100 KG105 KG125- KG317</p> <p>M280E M280E/.EF</p> <p>M280D M280D/.EF</p> <p>KG41 KG64</p> <p>M280B/. M280B/.EF</p> <p>KG10B KG20B KG32B KG41B KG64B KG80 KG100 KG105 KG125- KG317</p> <p>M700/.</p> <p>M701</p> <p>S1D M700 29</p>
Escutcheon Plate	Frame Plate	Handle	Lock Bar																							
A = brushed alu	black	black	red																							
B = brushed alu	black	red	yellow																							
C = brushed black	black	black	red																							
D = brushed black	black	red	yellow																							
E = yellow	black	red	yellow																							
<p>Ordering data:</p>	<p>Dimension from face of the switch to the cover or dimension from mounting surface to cover, the interlock program and the color selection.</p>																									

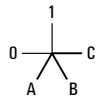
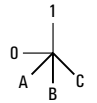
Padlock Devices	Type	Code
 <p>The padlock device is an integral part of the switch.</p> <p>For 2 padlocks Operation of the locking bar from the bottom. Available in black, red and electro-gray.</p>	<p>KG10A KG20A, KG32A KG10B KG20B, KG32B KG41-KG105</p>	<p>V840A</p>
 <p>For 4 padlocks Operation of the locking bar from the front. Available in black, red and electro-gray.</p>	<p>KG10A KG20A, KG32A KG41, KG64 KG10B KG20B, KG32B KG41B, KG64B KG80-KG105 KG80C-KG105C KG125-KG317</p>	<p>V845</p>
 <p>For mounting VE2 Operation of the locking bar from the front.</p>	<p>KG10A KG20A, KG32A KG41, KG64 KG80-KG105</p>	<p>V840B</p>
 <p>For distribution box with 70 mm depth.</p>	<p>KG20A, KG32A KG41, KG64</p>	<p>V840H../E</p>
 <p>Padlock device with integrated F- or B-handle. The cover disc is available in black, yellow and electro-gray. The handle may be supplied in black, red and electro-gray.</p>		
<p>For 2 padlocks with F-handle</p>	<p>KG10A KG20A, KG32A KG41, KG64</p>	<p>V840D</p>
<p>For 3 padlocks with F-handle</p>	<p>KG80C-KG105C KG125-KG162</p>	
<p>For 3 padlocks with F-handle with B-handle</p>	<p>KG10B KG20B, KG32B KG41B, KG64B KG80-KG105</p>	<p>V840G V840G/B</p>
<p>For 4 padlocks with F-handle with B-handle</p>		<p>V840F/F V840F/B</p>
 <p>Padlock device for switches with base mounting for locking when control cabinet is opened.</p> <p>Padlock devices with simplified door clutch and single hole mounting see page 16.</p>	<p>KG20B, KG32B KG41B, KG64B KG80-KG105 KG125-KG317</p>	<p>V840VE</p>
<p>Ordering data:</p>	<p>For V840 and V845 color selection required.</p>	

Additional Module for Motor Control Center (MCC), Angular drive	Type	Code
 <p>This additional module is for use in Motor Control Center (MCC). It allows for testing and unlocking, with up to 3 additional positions. The module is used in connection with the padlock device V840F and cam-operated auxiliary contacts. Interlock has to be assembled by the customer.</p> <p>ON-position: All circuits on, module interlocked, i. e. cannot be withdrawn.</p> <p>OFF-position: All circuits off, module interlocked, padlocks can be applied.</p> <p>Test position: Main incoming off, control circuits on, module interlocked.</p> <p>Isolated position: All circuits off, module can be withdrawn.</p> <p>Removed position: All circuits off, module can be removed.</p> <p>With 2 additional positions A = Test position B = Removed position</p>  <p>With 3 additional positions A = Test position B = Isolated position C = Removed position</p>  <p>With 3 additional positions A = Test position B = Isolated position C = Removed position</p>  <p>With 1 additional position A = Removed position</p> 	<p>KG20B KG32B KG41B KG64B</p> <p>KG20B KG32B KG41B KG64B</p> <p>KG20B KG32B KG41B KG64B</p> <p>KG20B KG32B KG41B KG64B</p>	<p>V500/1</p> <p>V500/2</p> <p>V500/3</p> <p>V500/4</p>
<p>Angular drive</p> 	<p>KG125- KG317¹</p>	<p>M330</p>

¹Only for ON/OFF switches 3 and 4 pole.

Selection Data	KG10	KG20	KG32	KG41	KG64	KG80	KG100	KG105	KG125	KG160	KG210	KG250	KG315
	KG10A	KG20A	KG32A	KG41B	KG64B	KG80C	KG100C	KG105C	KG126	KG161	KG211	KG251	KG316
	KG10B	KG20B	KG32B						KG127	KG162	KG212	KG252	KG317

Rated Insulation Voltage U_i IEC/VDE ¹ UL/Canada CEE/NEMKO	V	690	690	690	690	690	690	690	690	1000 ²	1000 ²	1000 ²	1000 ²	1000 ²	
	V	300	600	600	600	600	600	600	600	- ⁶	600	600	600	600	
	V	400	500	500	500	500	500	500	500	- ⁶	-	-	-	-	
Rated Impulse Withstand Voltage U_{imp} ¹	kV	4	6	6	6	6	6	6	6	8	8	8	8	8	
Rated Thermal Current IEC/VDE $I_{u, open} = I_{th}$ $I_{the, enclosed}$ UL/Canada ON/OFF function UL/Canada Double-throw function	A	20	25	32	40	63	80	100	125	125	160	200	250	315	
	A	20	25	32	40	63	80	100	125	125	160	200	250	315	
	A	20	25	30	40	60	80 ³	100 ³	- ⁶	150 ³	200 ³	200 ³	250 ³	300 ³	
	A	20	25	30	40	60	80 ³	100 ³	- ⁶	125 ³	160 ³	-	-	-	
Rated Operational Current I_e AC-21A Switching of resistive loads, including moderate overloads AC-22A Switching of combined resistive or low inductive loads, including moderate overloads Ampere-Rating ON/OFF function Double-throw function Resistive or low inductive loads	A	20	25	32	40	63	80	100	125	125	160	200	250	315	
	A	20	20	32	40	63	80	100	125	125	160	200	200	250	
	A	16	20	32	40	55	65	85	90	100	100	125	125	140	
	A	20	25	30	40	60	80 ³	100 ³	- ⁶	150 ³	200 ³	200 ³	250 ³	300 ³	
A	20	25	30	40	60	80 ³	100 ³	- ⁶	125 ³	160 ³	-	-	-		
Rated Utilization Category IEC/VDE AC-3 Direct-on-line starting 3 phase 3 pole 220 V-240 V 380 V-440 V 500 V 690 V AC-23A Frequent switching of motors or other high inductive loads 3 phase 3 pole 220 V-240 V 380 V-440 V 500 V 690 V DOL-Rating Standard motor load (similar AC-3) 3 phase 3 pole 120 V 240 V 480 V 600 V	kW	2,2	4	5,5	7,5	11	15	18,5	22	22	30	37	37	45	
	kW	3,7	5,5	7,5	11	18,5	22	30	37	37	45	55	55	75	
	kW	3,7	5,5	7,5	15	22	30	37	45	45	55	75	75	90	
	kW	3,7	5,5	7,5	11	15	18,5	22	22	30	37	40	45	45	
	kW	3	5,5	5,5	7,5	11	18,5	22	25	30	30	37	37	55	
	kW	5,5	7,5	11	15	22	30	37	45	45	55	75	90	110	
	kW	5,5	7,5	11	18,5	30	37	45	55	55	75	90	110	132	
	kW	5,5	7,5	11	15	18,5	22	30	30	37	37	45	45	45	
	HP	1	1,5	2	3	5	7,5	10	- ⁶	15	20	25	30	40	
	HP	2	3	5	7,5	10	20	25	- ⁶	30	40	50	60	75	
	HP	-	5	10	15	20	40	50	- ⁶	60	60	75	75	100	
	HP	-	5	10	15	20	50	50	- ⁶	60	60	75	75	100	
Short Circuit Protection Max. fuse size (gL-characteristic) Rated short-time withstand current (1 s-current)	A	20	35	35	50	63	80	100	125	125	160	200	250	315	
	A	130	350	430	500	580	1600	1850	2000	2500	3000	4000	4600	5800	
Max. Permissible Wire Gage - Use copper wire only For box terminal Single-core or stranded wire Flexible wire sleeving in accordance with DIN 46228 Flexible wire without sleeve Cable lug or track must accept connection screw Max. width Max. width with protective cover	mm ²	2,5	6	6	16	16	35(50) ⁵	35(50) ⁵	50	95	95	185	185	185	
	AWG	12	10	10	6	6	2(1/0)	2(1/0)	1/0	3/0	3/0	-	-	-	
	MCM	-	-	-	-	-	-	-	-	-	-	350	350	350	
	mm ²	2,5	4	4	10	10	25(35) ⁵	25(35) ⁵	35	70	70	120	120	120	
	mm ²	2,5	4	4	10	10	25(35) ⁵	25(35) ⁵	35	70	70	150	150	150	
	AWG	12	10	10	6	6	3(2)	3(2)	2	2/0	2/0	-	-	-	
	MCM	-	-	-	-	-	-	-	-	-	-	300	300	300	
	mm	-	-	-	-	-	-	-	-	M10 x 20	M10 x 20	M12 x 20	M12 x 20	M12 x 20	
	mm	-	-	-	-	-	-	-	-	20	20	25	25	25	
	mm	-	-	-	-	-	-	-	-	25	25	34	34	34	
	Ambient Temperature open at 100 % I_u/I_{th} enclosed at 100 % I_{the}		50 °C during 24 hours with peaks up to 55 °C												
			35 °C during 24 hours with peaks up to 40 °C												

20 ¹Valid for lines with common neutral termination, overvoltage category III, pollution degree 3. Values for other supply systems on request. ²Suitable for no load switching applications (AC-20A) above 690 V. ³Valid when connected with wire rated for 75 °C. ⁴International Standards and Approvals, refer to page 22. ⁵The values in brackets are valid for switches 4 pole. ⁶Ratings in preparation.















Technical Data

Auxiliary Contacts for KG Switches

Selection Data	KG10	KG20	Auxiliary contacts for:			
	KG10A	KG20B-	KG41-	KG125-	KG210-	
	KG10B	KG32B	KG105C	KG162	KG317	

Rated Insulation Voltage U_i		IEC/VDE UL/Canada	V	690	500	690	690	690
			V	300	600	600	600	600
Rated Thermal Current I_u/I_{th}		IEC/VDE/BS UL/Canada	A	10	-	16	16	16
			A	20	10	10	10	10
Rated Operational Current I_e								
AC-21A	Switching of resistive loads, including moderate overloads	IEC/VDE	A	20	10	16	16	16
AC-15	Switching of control devices, contactors, valves etc.	110 V-240 V 380 V-440 V 500 V	A	6	2,5	6	6	6
			A	4	1,5	3	3	3
			A	-	1	1,5	1,5	1,5
Pilot Duty	Heavy	UL/Canada		A300	A600	A600	A600	A600
Ampere-Rating	Resistive or low inductive loads	UL/Canada	A	20	10	10	10	10
Short Circuit Protection								
	Max. fuse size	(gL-characteristic)	A	20	10	16	16	16
Max. Permissible Wire Gage - Use copper wire only								
	Single-core or stranded wire	mm ² AWG		2,5	1,5	2,5	2,5	2,5
				12	14	12	12	12
	Flexible wire sleeving in accordance with DIN 46228	mm ²		2,5	1,5	2,5	2,5	2,5
	Flexible wire without sleeve	mm ² AWG		2,5	1,5	2,5	2,5	2,5
					12	16	14	14

Country	Authority	Mark or Standard	KG10	KG20	KG32	KG41	KG64	KG80	KG100	KG105	KG125	KG160	KG210	KG250	KG315
			KG10A	KG20A	KG32A	KG41B	KG64B	KG80C	KG100C	KG105C	KG126	KG161	KG211	KG251	KG316
			KG10B	KG20B	KG32B						KG127	KG162	KG212	KG252	KG317

USA	Underwriters Laboratories	 ¹ or 	●	●	●	●	●	●	●	— ⁷	●	●	●	●	●		
			●	●	●	●	●	●	●	●	— ⁷	●	●	●	●	●	
			●	●	●								●	●	●	●	●
Canada	Canadian Standards Association	 ² or 	●	●	●	●	●	●	●	— ⁷	●	●	●	●	●		
			●	●	●	●	●	●	●	●	— ⁷	●	●	●	●	●	
			●	●	●								●	●	●	●	●
Switzerland	Schweizerischer Elektrotechnischer Verein		+	+	+	+	+	+	+	+	+	+	+	+	+		
Danmark	Danmarks Elektriske Materieilkontrol		+	+	+	+	+	+	+	+	+	+	+	+	+		
Norway	Norges Elektriske Materieilkontrol		+	+	+	+	+	+	+	+	+	+	+	+	+		
Sweden	Svenska Elektriska Materieilkontrollanstalten		+	+	+	+	+	+	+	+	+	+	+	+	+		
Finland	Sähkötar-kastuskeskus		+	+	+	+	+	+	+	+	+	+	+	+	+		
Austria	Österreichischer Verband für Elektrotechnik		+	+	+	+	+	+	+	+	+	+	+	+	+		
Federal Republic of Germany	Verband Deutscher Elektrotechniker	VDE 0660 ³ VDE 0113 ³	+	+	+	+	+	+	+	+	+	+	+	+	+		
			+	+	+	+	+	+	+	+	+	+	+	+	+	+	
			+	+	+								+	+	+	+	+
Great Britain	British Standards Institution	BS EN 60947 ³	+	+	+	+	+	+	+	+	+	+	+	+	+		
			+	+	+	+	+	+	+	+	+	+	+	+	+	+	
			+	+	+								+	+	+	+	+
International Electrical Commission (IEC) Recommendation		IEC 60204-1 ⁴ IEC 60947-3 ⁴	+	+	+	+	+	+	+	+	+	+	+	+	+	+	
			+	+	+	+	+	+	+	+	+	+	+	+	+	+	+
			+	+	+								+	+	+	+	+
China	China Quality Certification Centre	 ⁶ GB14048.3		●	●	●	●										
				●	●	●	●										
				●	●												
Russian Federation	GOST	 ⁶ CH01	●	●	●	●	●	●	●	+	●	●	●	●	●		
			●	●	●	●	●	●	●	+	●	●	●	●	●	●	
			●	●	●								●	●	●	●	●
Germanischer Lloyd			+	+	+	+	+	+	+	+	+	+	+	+	+	+	
			+	+	+	+	+	+	+	+	+	+	+	+	+	+	+
			+	+	+								+	+	+	+	+
Lloyds Register of Shipping			+	+	+	+	+	+	+	+	+	+	+	+	+	+	
			+	+	+	+	+	+	+	+	+	+	+	+	+	+	+
			+	+	+								+	+	+	+	+

● Switch approved + Switch conforms to requirements

¹ Devices provided with terminals suitable to connect unprepared wires are approved under the "Listing Program" (File No. E35541, Guide No. NLRV). Devices with bolt terminals are approved under the "Recognized Component Program" (File No. E35541, Guide No. NLRV2).

² Approved by use of "UL Certification Services for Canada" (File No. E35541, Guide No. NLRV7 or NLRV8 respectively).

³ Industrial switchgear is not required to bear a symbol but must conform to requirements. By referring to the specific specification on the product the manufacturer implies that these requirements have been met.

⁴ IEC does not operate an approval program.

⁵ File No. 13002, Class No. 3211-05 resp. 4652-04.

⁶ If this approval is required, please request when ordering.

⁷ Ratings in preparation.

KG switches are approved by UL and CSA as „disconnect switches for use in motor circuits“. Switches using ring type terminations (KG127, KG162, KG212, KG252, KG317) it is necessary to make connections to separate terminals.

The switches described in this catalog exceed the requirements of IEC 60947-3 and VDE 0660 part 107 and meet the standard on main switches and maintenance switches.

The new series offers a 4 pole switch body and symmetrically placed contacts. The adjustable length through shaft offers increased stability and permits interlocking devices to be added at the end of the switch. While reduced forces of the latching mechanism allows for easier operation.

The safety level of the KH- and KHR-series in numerous areas surpasses those of many international standard organizations: Positive contact movement during making and breaking operations. Higher air and creepage distances as well as for 800 V or 1000 V and finger-proof terminals according to EN 50274, VDE 0660 part 514 and BGV A2 (protection IP 20 up to KHR40). Excellent AC-3 and AC-23A making and breaking capabilities providing

an additional safety advantage. For connecting with ring type terminals the KHR-series were designed. The terminal screw is held in place by a clamp allowing the ring type wire lug to be easily inserted in the terminal and tightened.

The KH- and KHR-series affords significant advantages during mounting and wiring. For ease of installation, switch terminations are on the same plane as the power conductors. Captive plus-minus screws and integrated screwdriver guides reduce wiring time. All base mounted switches feature a two hole mounting as well as "quick mount" designed for standard DIN rails according to EN 50022.

A large range of optional extras such as lateral mounted auxiliary contacts, ground terminals, auxiliary contacts (installed only at factory) also with contact systems for special programs, door clutches, shaft extensions and padlock devices enhance the flexibility of this proven line.

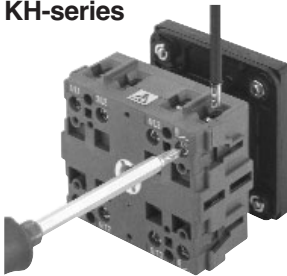

KH-series



KHR-series



Nominal Ratings

Escutcheon Plate Frame mm	Type	IEC 60947-3/VDE 0660 part 107		UL and Canada			
		Rated Values	Thermal Current	Utilization Category	Ampere-Rating	Standard Motor Load DOL-Rating	
		I_n/I_{th}	AC-23A	AC-3	3 x 600 V	3 x 240 V	3 x 480 V
		A	kW		A	HP	HP
48 x 48 	KH16	16	7,5	5,5	16	2	5
	KH20	20	10	6,5	20	2	5
	KH25	25	12	7,5	25	3	7,5
	KHR16	16	7,5	5,5	16	2	5
	KHR20	20	10	6,5	20	2	5
	KHR25	20	10	7,5	20	3	7,5
64 x 64 	KH16B	16	7,5	5,5	16	2	5
	KH20B	20	10	6,5	20	2	5
	KH25B	25	12	7,5	25	3	7,5
	KHR16B	16	7,5	5,5	16	2	5
	KHR20B	20	10	6,5	20	2	5
	KHR25B	20	10	7,5	20	3	7,5
	KH32	32	16	11	30	5	10
	KH40	40	20	15	40	7,5	15
	KHR32	32	16	11	30	5	10
KHR40	32	16	15	30	7,5	15	
64 x 64 	KH63	63	30	22	60	20	40
	KH80	80	40	30	80	25	50
	KHR63	63	30	22	60	20	40
	KHR80	80	40	30	80	25	50

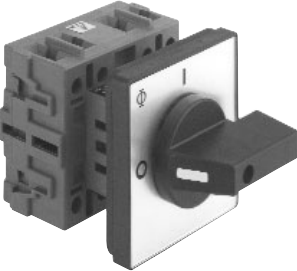
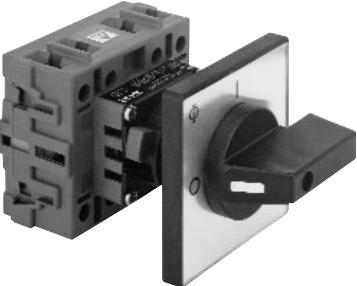
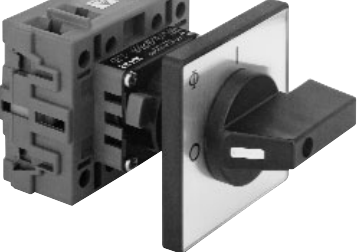
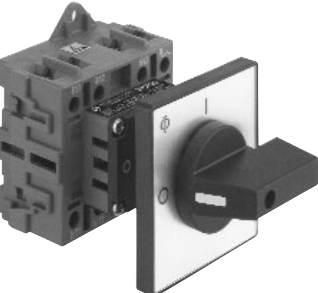
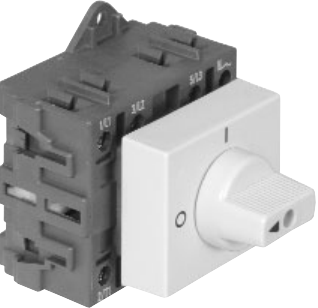
Mounting	Type	Code
 <p>Panel mounting protection IP 65 Four hole panel mounting</p>	KH16-KHR80	E
 <p>Single hole mounting 22 mm Protection IP 65 With square escutcheon plate 48 x 48 mm</p>	KH16-KHR25	FT2
 <p>With square escutcheon plate 64 x 64 mm</p>	KH16-KHR80	FH3¹
 <p>Base mounting Screw/Snap-on base mounting for track EN 50022 Protection IP 40</p>	KH16-KHR80	VE
 <p>Screw/Snap-on base mounting for track EN 50022. Escutcheon plate for 45 mm knock-out.</p>	KH16-KHR80	VE2

¹For KH63-KHR80 use flexible wire only in order to avoid excessive pressure on single hole mounting.







Plastic Enclosure Protection IP 66/67	Type	Code
---------------------------------------	------	------

	<p>The KL and CL enclosures are available in 3 sizes allowing for installation of 3, 4 and 6 pole KG switches. The KL-series is made of strong durable plastic and offers high UV-resistance. The CL-series is especially designed for applications in an aggressive environment, such as oil, chemical substances and grease. Each enclosure has 2 knock-outs on top and bottom for metric thread according to EN 50262. Included in each enclosure is a ground terminal.</p> <p>All enclosures can be supplied with a cover coupling for additional safety. Increased wiring space and mounting holes with slots are featured in this new line. These enclosures are also available for conduit entries for PG-thread.</p> <p>KS and CS enclosures have a compact size which allows for the installation of a 4 pole KH16/KHR16 ON/OFF switch or a KH20/KHR20 ON/OFF switch. The design, options and mounting are the same as those of the KL and CL enclosures.</p>	<p>KH16-KHR80</p> <p>KL. CL. KS. CS.</p>	
	Without cover interlock		0
	With cover interlock (The enclosure can only be opened at 9 o'clock position)		1
With cover interlock (The enclosure can only be opened at 12 o'clock position)	2		

Switch Function and Configuration

Function	KH16 KH20 KH25	KHR16 KHR20 KHR25	KH16B KH20B KH25B	KHR16B KHR20B KHR25B	KH32 KH40	KHR32 KHR40	KH63 KH80	KHR63 KHR80	Escutch. Plate	Code
----------	----------------------	-------------------------	-------------------------	----------------------------	--------------	----------------	--------------	----------------	-------------------	------

Types of Mounting

ON/OFF Switches 4 pole	E	E	E	E	E	E	E	E		K400-600
	FT2 FH3 VE VE2 KS./KL.	FT2 FH3 VE VE2 KS./KL.	KL.	KL.	FH3 VE VE2 KL.	FH3 VE VE2 KL.	FH3 VE VE2 KL.	FH3 VE VE2 KL.		K400-620
ON/OFF Switches 8 pole					E VE VE2	E VE VE2				K800-600
										K800-620
Double-throw Switches 4 pole					E VE VE2					K950-600
										K950-620

Connection Diagrams

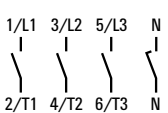
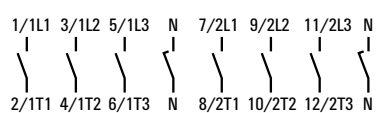
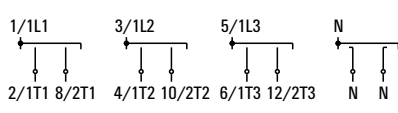
<p>ON/OFF Switches 4 pole</p> 	<p>ON/OFF Switches 8 pole</p> 	<p>Double-throw Switches 4 pole</p> 
--	--	--

Square and rectangular escutcheon plates are available for each size of switch. The escutcheon plate consists of a frame and a faceplate having the switch position which is then embossed with hot-foil backing. The escutcheon plate frame is an essential part of the switch and serves as a bearing surface for the handle. If the switch is to be mounted without an escutcheon plate we would recommend the handle bearing plate T100-04 which is available for switch types KH16B-KHR25B, KH32-KHR40 and KH63-KHR80. Escutcheon plates with special lettering are also available upon request.

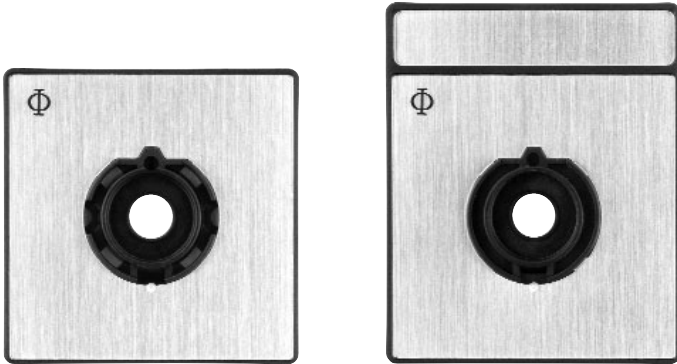

Escutcheon plate frame and faceplate can be obtained in different colors as listed below and defined in the first digit of the dash-number (1, 5, 6, 7):





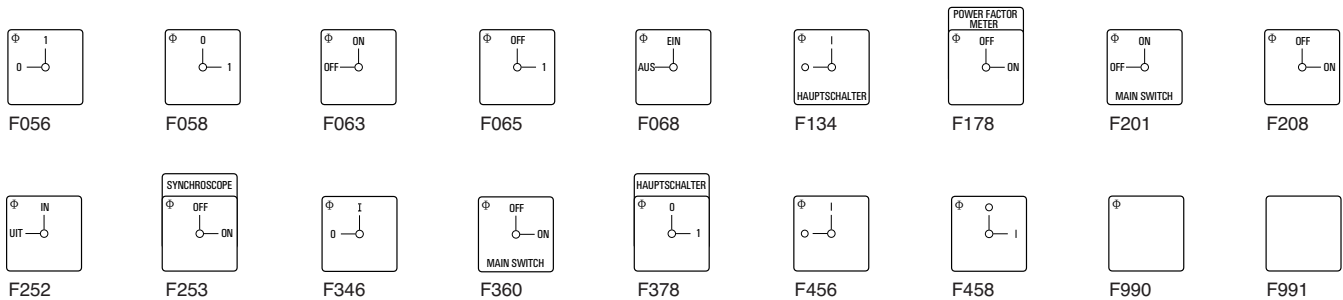

Switch Type	Escutcheon Plate Frame	Handle	Escutcheon Plate Backing	Escutcheon Plate Lettering	Dash-number
KH/KHR	electro-gray	electro-gray	brushed alu	black	-100
KH/KHR	electro-gray	electro-gray	black	mat silver	-500
KH/KHR	black	black	brushed alu	black	-600
KH/KHR	black	black	black	mat silver	-700

Standard Escutcheon Plates



Handles

KH, KHR Switches



Type	Color	Code	KH16- KH25	KHR16- KHR25	KH16B- KH25B	KHR16B- KHR25B	KH32- KHR40	KH63- KHR80
I-Handle 	black red white electro-gray	G251 G252 G253 G257	●	●	●	●	●	●
B-Handle 	black red white electro-gray	G521 G522 G523 G527	●	●	●	●	●	●
R-Handle 	black red white electro-gray	G001 G002 G003 G007	●	●	●	●	●	●
F-Handle 	black red white electro-gray	G221 G222 G223 G227	●	●	●	●	●	●
L-Handle 	black red white electro-gray	G501 G502 G503 G507	—	—	●	●	●	●
P-Handle  KH16-KHR25 KH16B-KHR80	black red white electro-gray	G211 G212 G213 G217	●	●	●	●	●	●
K-Handle 	black red white electro-gray	G411 G412 G413 G417	—	—	●	●	●	●

Protective Covers and Auxiliary Contacts	Type	Code
--	------	------

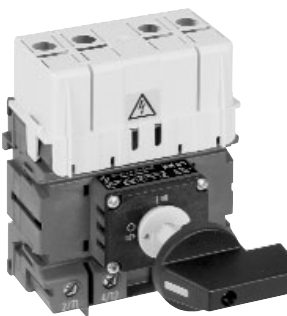
Protective Covers

	For mounting E	KH32-KHR40	K1 M160/45-E
	For mounting VE		K1 M160/45-VE
	For mounting E	KH63-KHR80	K1 M160/44-E
	For mounting VE		K1 M160/44-VE

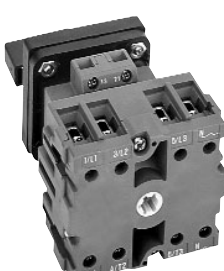
Cam-operated Auxiliary Contacts (mounting only at factory)

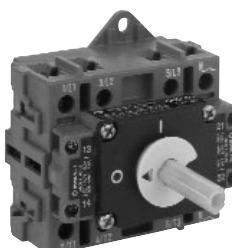
<p>For mounting E</p>  <p>KH16-KHR25B</p>	<p>Up to 4 cam-operated auxiliary contacts can be added to all switches.</p>	KH16-KHR80	M510A
 <p>KH32-KHR80</p>	<p>Select between a contact system with a rigid contact bridge for excellent AC-15 making and breaking capabilities or a H-bridge design with "cross-wire" contacts for low voltages and currents. The contact system with gold contacts or gold-plated contacts allow for use in aggressive environments also.</p>		
<p>For mounting VE</p> 			
<p>Ordering data:</p>	<p>Quantity and operation of the auxiliary contacts and type of the contact system.</p>		

Auxiliary Contacts, Ground Terminal and Shaft Extensions	Type	Code
--	------	------

Lateral mounted Auxiliary Contacts

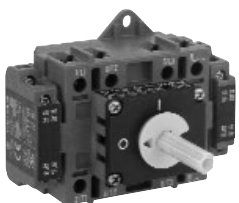
	Lateral mounted auxiliary contacts with 1 NO and 1 NC.		KH16-KHR25B	H010/A11-E H010/A11-VE			
	Standard contacts (nonoverlapping)	Terminal numbers					
		Attachment					
	For mounting E	left			right	KH32-KHR80	H010/11A-E H010/11A-VE
		For mounting VE			(33-34, 41-42)		
	For mounting E	(31-32, 43-44)			(51-52, 63-64)	KH16-KHR25B	H010/B11-E H010/B11-VE
		For mounting VE			(33-34, 41-42)		
	For mounting E	(31-32, 43-44)			(51-52, 63-64)	KH32-KHR80	H010/11B-E H010/11B-VE
		For mounting VE			(33-34, 41-42)		
	Overlapping contacts	(31-32, 43-44)			(51-52, 63-64)	KH16-KHR25B	H010/B11-E H010/B11-VE
For mounting E		(33-34, 41-42)	(53-54, 61-62)				
For mounting VE	(31-32, 43-44)	(51-52, 63-64)	KH32-KHR80	H010/11B-E H010/11B-VE			
For mounting E	(33-34, 41-42)	(53-54, 61-62)					
For mounting VE	(31-32, 43-44)	(51-52, 63-64)					

Ground Terminal

		KH16-KHR80	H052
--	--	------------	------



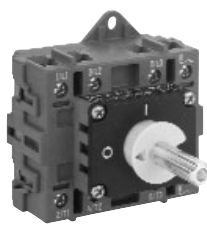
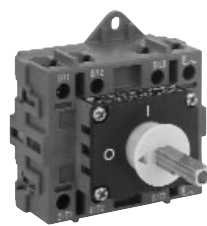

Shaft Extensions

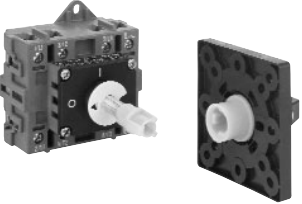
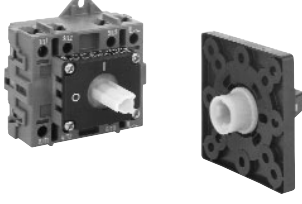
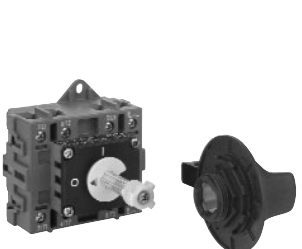
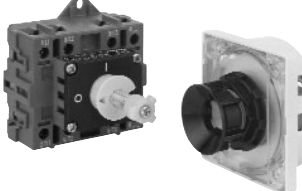
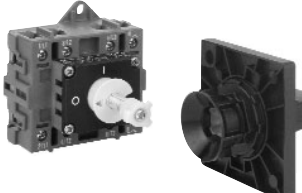
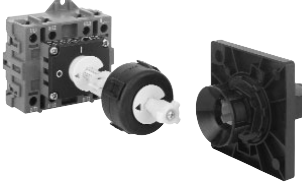

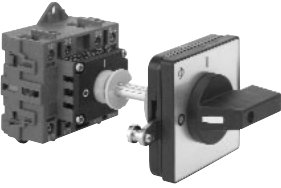

	With asymmetric profile	KH16-KHR80	L100 ¹
	Shaft length not adjustable		
	Shaft with adjustable length with set screw with shear ring		M004D ³ M004 ³
	With square profile		L100A ¹
	Shaft length not adjustable		
	Shaft with adjustable length with set screw		M004E ²
Ordering data:		Free shaft length or dimension from mounting surface to cover.	

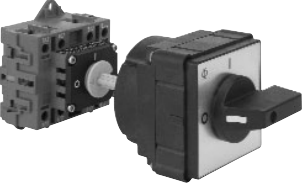
¹Available for switch types from KH16B. ²Available for switch types from KH32. ³Not available for KH..B.







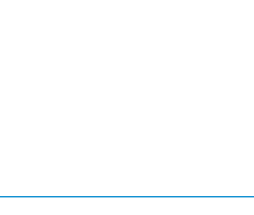

Simplified Door Clutch	Type	Code	
	KH16-KHR80	M290/A3	
<p>The simplified door clutches are utilized primarily when the switch is mounted to the bottom of the enclosure and the handle and escutcheon plate are mounted on the cover.</p> <p>With shaft extension Front protection IP 40</p>			
			M290/A1.EF ²
<p>With profile extension parts Front protection IP 65</p>			
			V840E ¹
<p>With padlock device, single hole mounting 22 mm, protection IP 65. An additional aluminum shaft extension is required.</p>			
			V840G ¹ V840F ¹
<p>The cover disc is available in black, yellow and electro-gray. The handle may be supplied in black, red and electro-gray.</p>			
	V845		
<p>Operation of the locking bar from the front. Available in black, red and electro-gray.</p>			
	M600 ¹		
<p>Centering device for simplified door clutches with single hole mounting and shaft extension Misalignment between the shaft and mounting are compensated in all 4 directions.</p>			
<p>Ordering data:</p>	<p>Free shaft length or dimension from face of the switch to the cover and color selection.</p>		

¹Available for switch types from KH16B. ²Available for switch types from KH32.

Door Clutches	Type	Code																								
 <p>The M280 door clutch has an adjustable shaft and can be supplied with an interlock device.</p> <p>The following interlock programs are available:</p> <p>A = Without interlock by door clutch B = With interlock by door clutch C = With interlock by rods D = With interlock by door clutch and rods</p> <p>With protected profile</p> <p>shaft fixation with set screw Front protection IP 40 Front protection IP 66/67 (KG10A-KG32A: IP 65)</p> <p>shaft fixation with shear ring Front protection IP 40 Front protection IP 66/67 (KG10A-KG32A: IP 65)</p> <p>The M700 is a padlockable door clutch and a mechanical interlocking safety device. Using the device the electrical panel may be opened only when the switch is in the "OFF" position.</p> <p>NOTE: Knowledgeable personnel using a simple tool are able to defeat the interlock.</p> <p>The M700's flexibility allows for successful installation with as much as + or - 5 mm of misalignment between shaft and door.</p>  <p>Handle lockable with padlocks Protection IP 65</p> <p>Selection of escutcheon plate and handle color required:</p> <table border="1" data-bbox="529 1415 1161 1653"> <thead> <tr> <th>Escutcheon Plate</th> <th>Frame Plate</th> <th>Handle</th> <th>Lock Bar</th> </tr> </thead> <tbody> <tr> <td>A = brushed alu</td> <td>black</td> <td>black</td> <td>red</td> </tr> <tr> <td>B = brushed alu</td> <td>black</td> <td>red</td> <td>yellow</td> </tr> <tr> <td>C = brushed black</td> <td>black</td> <td>black</td> <td>red</td> </tr> <tr> <td>D = brushed black</td> <td>black</td> <td>red</td> <td>yellow</td> </tr> <tr> <td>E = yellow</td> <td>black</td> <td>red</td> <td>yellow</td> </tr> </tbody> </table>  <p>Standard handle and standard escutcheon plate Protection IP 65</p>  <p>Unlock insert for the M700 to open the door in ON position. (After the locking has been made inactive, it is necessary to take effective precautions against an opening of the door by unauthorized persons.)</p>	Escutcheon Plate	Frame Plate	Handle	Lock Bar	A = brushed alu	black	black	red	B = brushed alu	black	red	yellow	C = brushed black	black	black	red	D = brushed black	black	red	yellow	E = yellow	black	red	yellow	<p>KH16-KHR80</p> <p>KH16B-KHR80</p>	<p>M280E M280E/.EF</p> <p>M280D M280D/.EF</p> <p>M700/.</p> <p>M701</p> <p>S1D M700 29</p>
Escutcheon Plate	Frame Plate	Handle	Lock Bar																							
A = brushed alu	black	black	red																							
B = brushed alu	black	red	yellow																							
C = brushed black	black	black	red																							
D = brushed black	black	red	yellow																							
E = yellow	black	red	yellow																							
<p>Ordering data:</p>	<p>Dimension from face of the switch to the cover or dimension from mounting surface to cover, the interlock program and the color selection.</p>																									

Padlock Devices	Type	Code
<p>The padlock device is an integral part of the switch.</p>  <p>For 2 padlocks Operation of the locking bar from the bottom. Available in black, red and electro-gray.</p>  <p>For 4 padlocks Operation of the locking bar from the front. Available in black, red and electro-gray.</p> <p>Padlock device with integrated F- or B-handle. The cover disc is available in black, yellow and electro-gray. The handle may be supplied in black, red and electro-gray.</p>  <p>For 2 padlocks with F-handle</p>  <p>For 3 padlocks with F-handle with B-handle</p>  <p>For 4 padlocks with F-handle with B-handle</p> <p>Padlock devices with simplified door clutch and single hole mounting see page 30.</p>	<p>KH16-KHR80</p> <p>KH16-KHR25</p> <p>KH16B-KHR80</p>	<p>V840A</p> <p>V845</p> <p>V840D</p> <p>V840G V840G/B</p> <p>V840F/F V840F/B</p>
<p>Ordering data:</p>	<p>For V840 and V845 color selection required.</p>	

Country	Authority	Mark or Standard	KH16 KH16B	KHR16 KHR16B	KH20 KH20B	KHR20 KHR20B	KH25 KH25B	KHR25 KHR25B	KH32 KHR32	KH40 KHR40	KH63 KHR63	KH80 KHR80
---------	-----------	------------------	---------------	-----------------	---------------	-----------------	---------------	-----------------	---------------	---------------	---------------	---------------

USA	Underwriters Laboratories		●	●	●	●	●	●	●	●	●	●
Canada	Canadian Standards Association		●	●	●	●	●	●	●	●	●	●
Switzerland	Schweizerischer Elektrotechnischer Verein		+	+	+	+	+	+	+	+	+	+
Danmark	Danmarks Elektriske Materielkontrol		+	+	+	+	+	+	+	+	+	+
Norway	Norges Elektriske Materielkontrol		+	+	+	+	+	+	+	+	+	+
Sweden	Svenska Elektriska Materielkontrollanstalten		+	+	+	+	+	+	+	+	+	+
Finland	Sähkötar-kastuskeskus		+	+	+	+	+	+	+	+	+	+
Austria	Österreichischer Verband für Elektrotechnik		+	+	+	+	+	+	+	+	+	+
Federal Republic of Germany	Verband Deutscher Elektrotechniker	VDE 0660 ¹ VDE 0113 ¹	+	+	+	+	+	+	+	+	+	+
Great Britain	British Standards Institution	BS EN 60947 ¹	+	+	+	+	+	+	+	+	+	+
International Electrical Commission (IEC) Recommendation		IEC 60204-1 ² IEC 60947-3 ²	+	+	+	+	+	+	+	+	+	+
Russian Federation	GOST	 CH01 ⁴	●	+	●	+	●	+	●	●	●	●

- Switch approved
- + Switch conforms to requirements

¹Industrial switchgear is not required to bear a symbol but must conform to requirements. By referring to the specific specification on the product the manufacturer implies that these requirements have been met.

²IEC does not operate an approval program.

³File No. 13002, Class No. 3211-05 resp. 4652-04.

⁴If this approval is required, please request when ordering.

The switches of the KH/KHR-series are approved by UL and CSA as „disconnect switches for use in motor circuits“. UL approved terminals are required when making connection to switches having ring type terminations (KHR).

Selection Data	KH16	KHR16	KH20	KHR20	KH25	KHR25	KH32		KH63	KH80
	KH16B	KHR16B	KH20B	KHR20B	KH25B	KHR25B	KHR32	KH40	KHR40	KHR63

Rated Insulation Voltage U_i	IEC/EN/VDE ¹	V	800 ²	800 ²	800 ²	800 ²	800 ²	800 ²	800 ²	800 ²	800 ²	1000 ²	1000 ²		
	UL/Canada	V	600	600	600	600	600	600	600	600	600	600	600		
Rated Impulse Withstand Voltage U_{imp}¹		kV	6	6	6	6	6	6	6	6	6	8	8		
Rated Thermal Current	IEC/EN/VDE	I_u open = I_{th}	A	16	16	20	20	25	20	32	40	32	63	80	
		I_{the} enclosed	A	16	16	20	20	25	20	32	40	32	63	80	
	UL/Canada	A	16	16	20	20	25	20	30	40	30	60	80		
Rated Operational Current I_e															
AC-21A	Switching of resistive loads, including moderate overloads	IEC/EN/VDE	A	16	16	20	20	25	20	32	40	32	63	80	
AC-22A	Switching of combined resistive or low inductive loads, including moderate overloads	IEC/EN/VDE	A	16	16	20	20	25	20	32	40	32	63	80	
Ampere-Rating	Resistive or low inductive loads	UL/Canada	A	16	16	20	20	25	20	30	40	30	60	80	
Rated Utilization Category	IEC/EN/VDE														
AC-3	Direct-on-line starting	3 phase	220 V-240 V	kW	3	3	3,5	3,5	4	4	5,5	7,5	7,5	11	15
			3 pole	380 V-440 V	kW	5,5	5,5	6,5	6,5	7,5	7,5	11	15	15	22
		500 V	660 V-690 V	kW	5,5	5,5	6,5	6,5	7,5	7,5	11	15	15	30	37
			660 V-690 V	kW	5,5	5,5	6,5	6,5	7,5	7,5	11	15	15	18,5	22
AC-23A	Frequent switching of motors or other high inductive loads	3 phase	220 V-240 V	kW	4,5	4,5	5,5	5,5	7	5,5	9	11	9	18,5	23
			3 pole	380 V-440 V	kW	7,5	7,5	10	10	12	10	16	20	16	30
		500 V	660 V-690 V	kW	10	10	12	12	15	13	20	25	20	40	55
			660 V-690 V	kW	13	13	15	15	17	17	22	25	25	30	37
DOL-Rating	Standard motor load (similar AC-3)	UL/Canada	110 V-120 V	HP	1	1	1	1	1,5	1,5	2	3	3	7,5	10
			3 phase	220 V-240 V	HP	2	2	2	2	3	3	5	7,5	7,5	20
		3 pole	440 V-480 V	HP	5	5	5	5	7,5	7,5	10	15	15	30	40
			550 V-600 V	HP	5	5	5	5	7,5	7,5	10	15	15	40	50
Short Circuit Protection															
	Max. fuse size (gL-characteristic)	A	25	25	35	35	35	35	35	35	50	50	80	100	
	Rated short-time withstand current (1s-current)	A	400	400	450	450	500	500	850	950	950	1200	1600		
Max. Permissible Wire Gage - Use copper wire only															
KH	For box terminal	Single-core or stranded wire	mm ²	6	-	6	-	6	-	10	10	-	35	35	
			AWG	10	-	10	-	10	-	8	8	-	2	2	
		Flexible wire sleeving in accordance with DIN46228	mm ²	4	-	4	-	4	-	6	6	-	25	25	
			AWG	12	-	12	-	12	-	10	10	-	4	4	
KHR	Connection with insulated ring and fork type terminals	Internal diameter ≥ External diameter ≤	mm	-	3,2	-	3,2	-	3,2	3,7	-	3,7	5,2	5,2	
			mm	-	7,4	-	7,4	-	7,4	8,8	-	8,8	12,7	12,7	
Ambient Temperature	open at 100 % I_u/I_{th} enclosed at 100 % I_{the}		50 °C during 24 hours with peaks up to 55 °C 35 °C during 24 hours with peaks up to 40 °C												

¹Valid for lines with grounded common neutral termination, overvoltage category III, pollution degree 3. Values for other supply systems on request.

²Suitable for no load switching applications (AC-20A) above 690 V.

Technical Data

Auxiliary Contacts for KH, KHR Switches

Selection Data	Auxiliary contacts for: KH16-KHR80
-----------------------	---------------------------------------

Rated Insulation Voltage U_i	IEC/EN/VDE	V	440			
	UL/Canada	V	300			
Rated Thermal Current I_{θ}/I_{th}	IEC/EN/VDE	A	10			
	UL/Canada	A	10			
Rated Operational Current I_e	AC-21A	Switching of resistive loads, including moderate overloads	IEC/EN/VDE	A	10	
	AC-15	Switching of control devices, contactors, valves etc.	110 V-240 V 380 V-440 V	A	2,5	
				A	1,5	
	Pilot Duty	Heavy	UL/Canada			A300
	Ampere-Rating	Resistive or low inductive loads	UL/Canada	A		10
Short Circuit Protection						
	Max. fuse size	(gL-characteristic)		A		10
Max. Permissible Wire Gage - Use copper wire only						
	Single-core or stranded wire			mm ²	1,5	
				AWG	14	
	Flexible wire sleeving in accordance with DIN46228			mm ²	1,5	
				AWG	16	

Mounting

(Additional length for auxiliary contacts see page 40)

ON/OFF Switches 3 and 4 pole

E		A	B	C	D1	D2	D3	E	F	G	G1 ¹	H	L
	KG10A	48	36	4	11-15	5	-	-	48	48	-	50	48,2
		1.89	1.42	.16	.43-.59	.20	-	-	1.89	1.65	-	1.97	1.90
	KG10B	64	48	4	11-15	5	-	-	64	48	-	50	57,2
		2.52	1.89	.16	.43-.59	.20	-	-	2.52	1.65	-	1.97	2.25
	KG20, KG32	30	-	4	8-11	-	3,2	20	-	42	13,5	54	50,8
		1.18	-	.16	.31-.43	-	.13	.79	-	1.65	.53	2.13	2.00
	KG20A, KG32A	48	36	4	10-15	5	-	-	48	42	13,5	54	53,8
		1.89	1.42	.16	.39-.59	.20	-	-	1.89	1.65	.53	2.13	2.12
	KG20B, KG32B	64	48	4	10-15	5	-	-	64	42	13,5	54	53,8
		2.52	1.89	.16	.39-.59	.20	-	-	2.52	1.65	.53	2.13	2.12
	KG41, KG64	48	36	4	10-15	5	-	-	64	50	16	64	60,5
		1.89	1.42	.16	.39-.59	.20	-	-	2.52	1.97	.63	2.52	2.38
	KG41B, KG64B	64	48	4	10-15	5	-	-	64	50	16	64	60,5
		2.52	1.89	.16	.39-.59	.20	-	-	2.52	1.97	.63	2.52	2.38
	KG80, KG100	64	48	4	10-15	5	-	-	88	70	22	80	70,6
		2.52	1.89	.16	.39-.59	.20	-	-	3.46	2.76	.87	3.15	2.78
KG80C, KG100C	88	68	4	10-15	6	-	-	88	70	22	80	70,6	
	3.46	2.68	.16	.39-.59	.24	-	-	3.46	2.76	.87	3.15	2.78	
KG105	64	48	4	10-15	5	-	-	88	92	0	80	70,6	
	2.52	1.89	.16	.39-.59	.20	-	-	3.46	3.62	0	3.15	2.78	
KG105C	88	68	4	10-15	6	-	-	88	92	0	80	70,6	
	3.46	2.68	.16	.39-.59	.24	-	-	3.46	3.62	0	3.15	2.78	

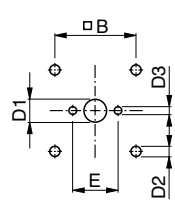

	A	B	C	D1	D2	G	G1 ¹	H	L	N
KG125, KG160	88	68	5,5	13-17	6	112	38	108	96	-
	3.46	2.68	.22	.51-.67	.24	4.41	1.50	4.25	3.78	-
KG210, KG250, KG315	88	68	5,5	13-17	6	145	52,5	126	103	-
	3.46	2.68	.22	.51-.67	.24	5.71	2.07	4.96	4.05	-
KG126, KG161	88	68	5,5	13-17	6	112	38	110	96	45
	3.46	2.68	.22	.51-.67	.24	4.41	1.50	4.33	3.78	1.77
KG211, KG251, KG316	88	68	5,5	13-17	6	145	52,5	126	103	50
	3.46	2.68	.22	.51-.67	.24	5.71	2.07	4.96	4.05	1.97
KG127, KG162	88	68	5,5	13-17	6	112	38	109	96	45
	3.46	2.68	.22	.51-.67	.24	4.41	1.50	4.29	3.78	1.77
KG212, KG252, KG317	88	68	5,5	13-17	6	145	52,5	126	103	50
	3.46	2.68	.22	.51-.67	.24	5.71	2.07	4.96	4.05	1.97

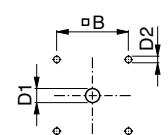
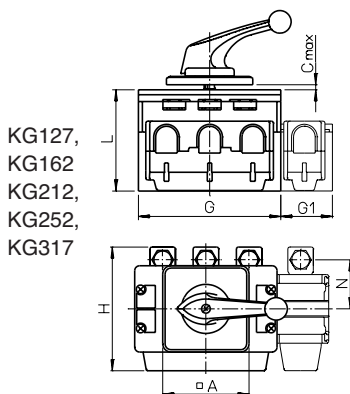
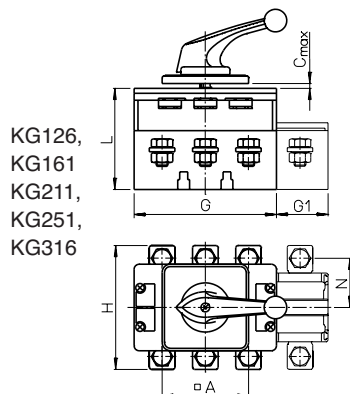
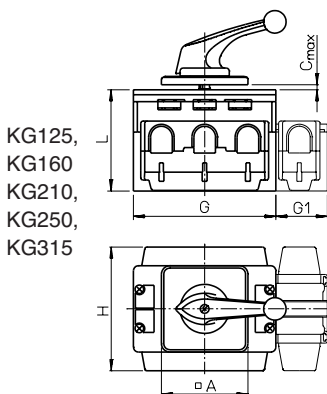

FT1, FT2

KG10A

KG20A, KG32A

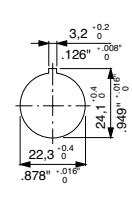
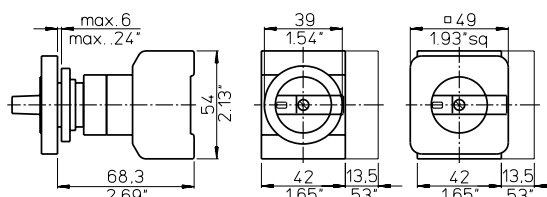
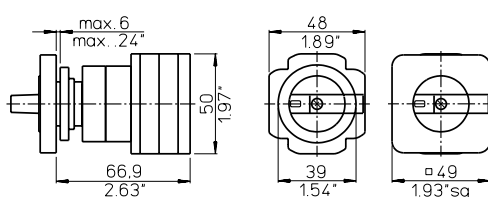

¹For ON/OFF switches 4 pole.

Mounting
(Additional length for auxiliary contacts see page 40)

ON/OFF Switches 3 and 4 pole

VE, VE1	A	B	C	D1	D2	D3	E1 ¹	E2 ¹	E3 ¹	F	G	G1 ²	H	L	M
KG10A	48	36	12	8-15	5	4,2	60	65	50	22	48	-	50	49,2	-
KG10B	64	48	29	10-15	5	4,2	60	65	50	22	48	-	50	56,2	-
KG20, KG32	30	-	12	8-11	3,2	4,1	60	-	-	22	42	13,5	54	50	20
KG20A, KG32A	48	36	12	8-15	5	4,1	60	-	-	22	42	13,5	54	50	-
KG20B, KG32B	64	48	13,5	10-15	5	4,1	60	-	-	22	42	13,5	54	50	-
KG41, KG64	48	36	12	10-15	5	4,1	70	-	-	25	50	16	64	61	-
KG41B, KG64B	64	48	13,5	10-15	5	4,1	70	-	-	25	50	16	64	61	-
KG80, KG100	64	48	13,5	10-15	5	5,2	90	-	-	25	70	22	80	68	-
KG80C, KG100C	88	68	13,5	10-15	6	5,2	90	-	-	25	70	22	80	68	-
KG105	64	48	13,5	10-15	5	5,2	90	-	-	25	92	0	80	68	-
KG105C	88	68	13,5	10-15	6	5,2	90	-	-	25	92	0	80	68	-

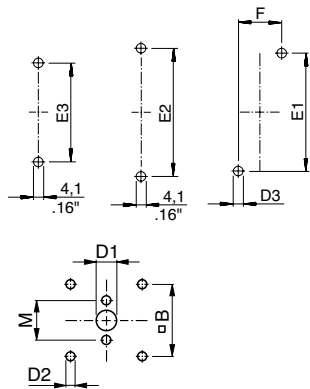
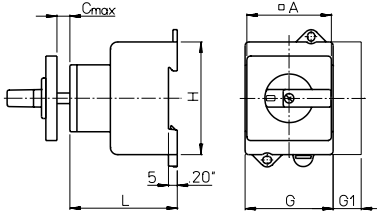

	A	B	C	D1	D2	D3	G	G1 ²	H	L ³	N	P	Q1	Q2
KG125, KG160	88	68	16	13-17	6	6,4	112	38	108	91	-	36	59-61	59-61
KG210, KG250, KG315	88	68	16	13-17	6	6,4	145	52,5	126	98	-	44	70-72	70-72
KG126, KG161	88	68	16	13-17	6	6,4	112	38	110	91	45	36	38-40	38-40
KG211, KG251, KG316	88	68	16	13-17	6	6,4	145	52,5	126	98	50	44	40-42	40-42
KG127, KG162	88	68	16	13-17	6	6,4	112	38	109	91	45	36	38-40	59-61
KG212, KG252, KG317	88	68	16	13-17	6	6,4	145	52,5	126	98	50	44	40-42	70-72

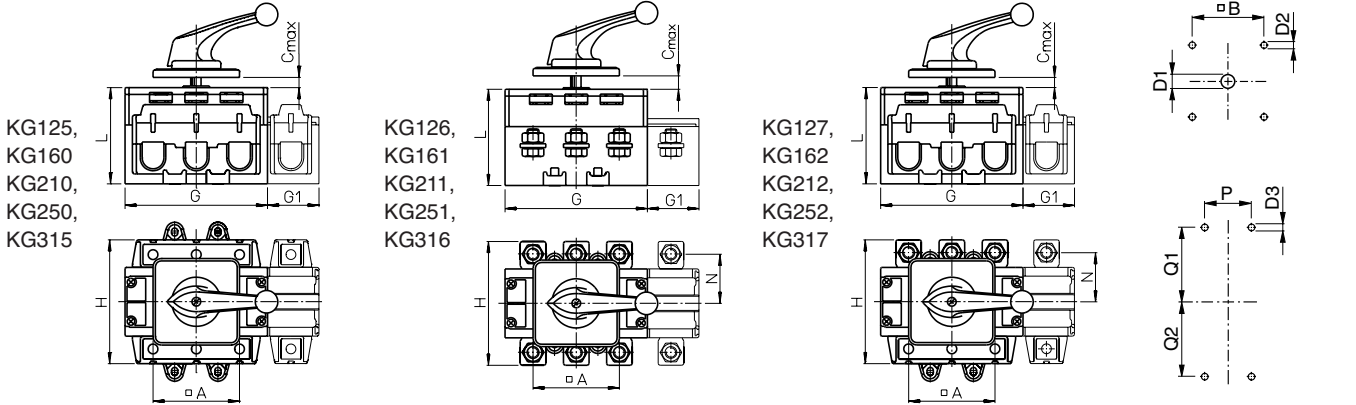

VE2	A	B	G	G1 ²	L	VE21
KG20A, KG32A	43,7	45,4	42	13,5	56,5	
KG41, KG64	52,4	45,4	50	16	56,5	
KG80, KG100	70	45	70	22	65	
KG105	70	45	92	0	65	
KG125-KG162	112	45	112	38	98	
	4,41	1,77	4,41	1,50	3,86	

¹Switches KG10A and KG10B allow use of E1, E2 or E3. ²For ON/OFF switches 4 pole. ³KG125-KG162 additional length for mounting VE1 = 7,5 mm/.30 inch.

Mounting

(Additional length for auxiliary contacts see page 40)

ON/OFF Switches 6 pole and Double-throw Switches

E		A	B	C	D1	D2	F	G	G1 ¹	H	L
	KG10A	48	36	4	11-15	5	48	48	-	50	57,7
		1.89	1.42	.16	.43-.59	.20	1.89	1.89	-	1.97	2.27
	KG10B	64	48	4	11-15	5	64	48	-	50	66,7
		2.52	1.89	.16	.43-.59	.20	2.52	1.89	-	2.13	2.84
	KG20A, KG32A	48	36	4	10-15	5	48	84	13,5	54	61,3
		1.89	1.42	.16	.39-.59	.20	1.89	3.30	.53	2.13	2.41
	KG20B, KG32B	64	48	4	10-15	5	64	84	13,5	54	61,3
		2.52	1.89	.16	.39-.59	.20	2.52	3.31	.53	2.13	2.41
	KG41B, KG64B	64	48	4	10-15	5	64	100	16	64	66,5
		2.52	1.89	.16	.39-.59	.20	2.52	3.94	.63	2.52	2.62
KG80, KG100	64	48	4	10-15	5	88	140	22	80	81,8	
	2.52	1.89	.16	.39-.59	.20	3.46	5.51	.87	3.15	3.22	
KG80C, KG100C	88	68	4	10-15	6	88	140	22	80	81,8	
	3.46	2.68	.16	.39-.59	.24	3.46	5.51	.87	3.15	3.22	
KG105	64	48	4	10-15	5	88	162	0	80	81,8	
	2.52	1.89	.16	.39-.59	.20	3.46	6.38	0	3.15	3.22	
KG105C	88	68	4	10-15	6	88	162	0	80	81,8	
	3.46	2.68	.16	.39-.59	.24	3.46	6.38	0	3.15	3.22	

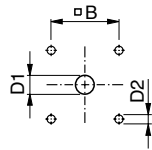

	A	B	C	D1	D2	G	G1 ¹	H	L	N
KG125, KG160	88	68	5,5	13-17	6	224	38	108	98	-
	3.46	2.68	.22	.51-.67	.24	8.82	1.50	4.25	3.86	-
KG126, KG161	88	68	5,5	13-17	6	224	38	110	98	45
	3.46	2.68	.22	.51-.67	.24	8.82	1.50	4.33	3.86	1.77
KG127, KG162	88	68	5,5	13-17	6	224	38	109	98	45
	3.46	2.68	.22	.51-.67	.24	8.82	1.50	4.29	3.86	1.77

KG125, KG160

KG126, KG161

KG127, KG162

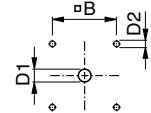
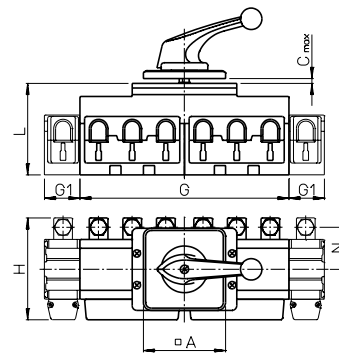
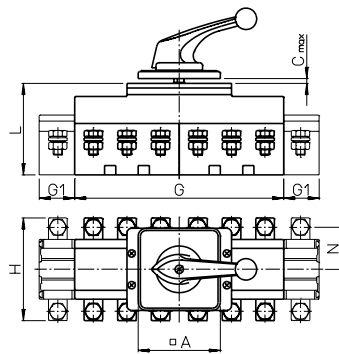
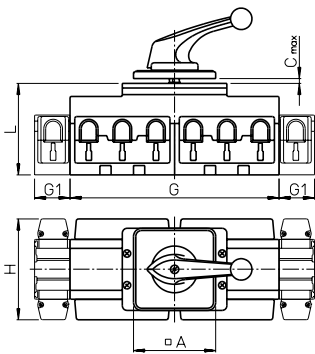

FT1, FT2

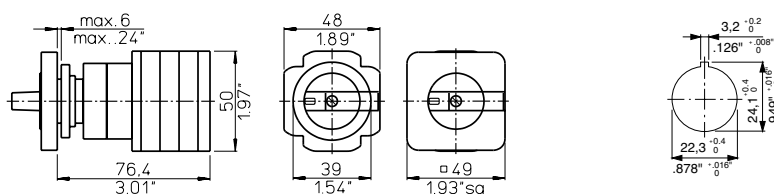

¹For double-throw switches 4 pole.

Mounting

(Additional length for auxiliary contacts see page 40)

ON/OFF Switches 6 pole and Double-throw Switches

VE, VE1

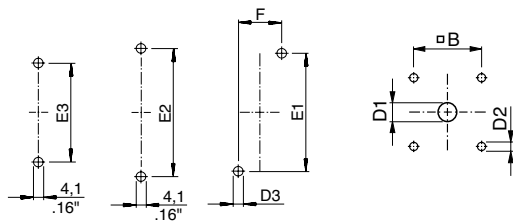
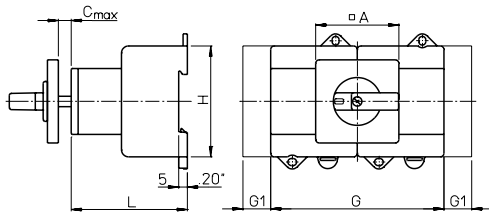

ON/OFF switches 6 pole
double-throw switches 3 pole

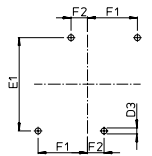

double-throw switches 4 pole

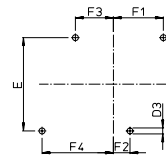

	A	B	C	D1	D2	D3	E1 ¹	E2 ¹	E3 ¹	F	F1
KG10A	48	36	12	8-15	5	4,2	60	65	50	22	-
KG10B	64	48	29	10-15	5	4,2	60	65	50	22	-
KG20A, KG32A	48	36	12	8-15	5	4,1	60	-	-	-	32
KG20B, KG32B	64	48	13,5	10-15	5	4,1	60	-	-	-	32
KG41B, KG64B	64	48	13,5	10-15	5	4,1	70	-	-	-	37,5
KG80, KG100	64	48	13,5	10-15	5	5,2	90	-	-	-	47,5
KG105	2,52	1,89	.53	.39-.59	.20	.21	3,54	-	-	-	1,87
KG80C, KG100C	88	68	13,5	10-15	6	5,2	90	-	-	-	47,5
KG105C	3,46	2,68	.53	.39-.59	.24	.21	3,54	-	-	-	1,87

	F2	F3	F4	G	G1 ²	H	L
KG10A	-	-	-	48	-	50	58,7
KG10B	-	-	-	48	-	50	65,7
KG20A, KG32A	10	23,5	45,5	84	13,5	54	57,5
KG20B, KG32B	10	23,5	45,5	84	13,5	54	57,5
KG41B, KG64B	12,5	28,5	53,5	100	16	64	67
KG80, KG100	22,5	44,5	69,5	140	22	80	79,2
KG80C, KG100C	22,5	44,5	69,5	140	22	80	79,2
KG105, KG105C	22,5	44,5	69,5	162	0	80	79,2
	.89	1,75	2,74	6,38	0	3,15	3,12

	A	B	C	D1	D2	D3	G	G1 ²	H	L ³	N	P	Q1	Q2
KG125, KG160	88	68	16	13-17	6	6,4	224	38	108	93	-	76	59-61	59-61
	3,46	2,68	.63	.51-.67	.24	.25	8,82	1,50	4,25	3,66	-	2,99	2,32-2,40	2,32-2,40
KG126, KG161	88	68	16	13-17	6	6,4	224	38	110	93	45	76	38-40	38-40
	3,46	2,68	.63	.51-.67	.24	.25	8,82	1,50	4,33	3,66	1,77	2,99	1,50-1,57	1,50-1,57
KG127, KG162	88	68	16	13-17	6	6,4	224	38	109	93	45	76	38-40	59-61
	3,46	2,68	.63	.51-.67	.24	.25	8,82	1,50	4,29	3,66	1,77	2,99	1,50-1,57	2,32-2,40

KG125, KG160

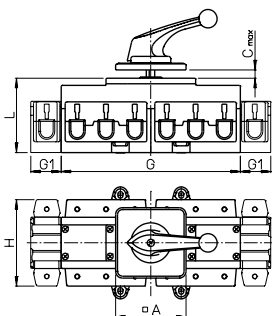

KG126, KG161

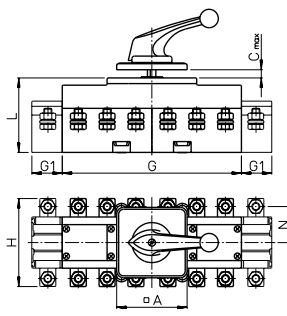

KG127, KG162

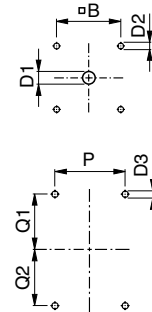
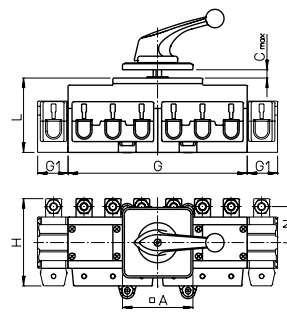

VE2

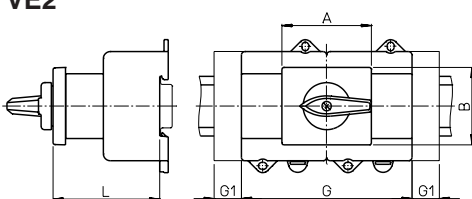

	A	B	G	G1 ²	L
KG20A, KG32A	43,7	45,4	84	13,5	64
	1,72	1,79	3,31	.53	2,52
KG41B, KG64B	52,4	45,4	100	16	62,5
	2,06	1,79	3,94	.63	2,46
KG80, KG100	70	45	140	22	76,2
	2,76	1,77	5,51	.87	3,00
KG105	70	45	162	0	76,2
	2,76	1,77	6,38	0	3,00

VE21

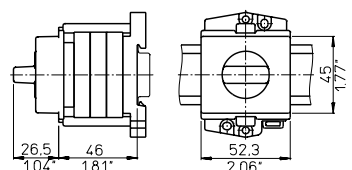

¹Switches KG10A and KG10B allow use of E1, E2 or E3. ²For double-throw switches 4 pole. ³Additional length for mounting VE1 = 7,5 mm/.30 inch.

Plastic Enclosures and Optional Extras

Switches in Plastic Enclosure

KL..., CL..., KS5., CS5.

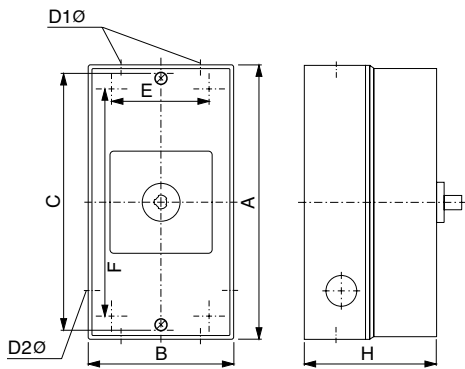

	3 and 4 pole	6 pole	A	B	C	D1	D2	E	F	H
KG10 ¹	x	x	120	85	110	2x20	20	-	-	80
			4.72	3.35	4.33	2x.79	.79	-	-	3.15
KG20 ¹	x		120	85	110	2x20	20	-	-	80
			4.72	3.35	4.33	2x.79	.79	-	-	3.15
KG20, KG32	x		160	85	150	2x20	20	-	-	80
			6.30	3.35	5.91	2x.79	.79	-	-	3.15
KG20B, KG32B		x	190	100	178	2x25	25	-	-	91
			7.48	3.94	7.01	2x.98	.98	-	-	3.58
KG41, KG64	x		190	100	178	2x25	25	-	-	91
			7.48	3.94	7.01	2x.98	.98	-	-	3.58
KG41B, KG64B		x	250	145	-	2x40	25	124	229	107
			9.84	5.71	-	2x1.57	.98	4.88	9.02	4.21
KG80, KG100	x		250	145	-	2x40	25	124	229	107
			9.84	5.71	-	2x1.57	.98	4.88	9.02	4.21
KG105										

PFA-PFF5

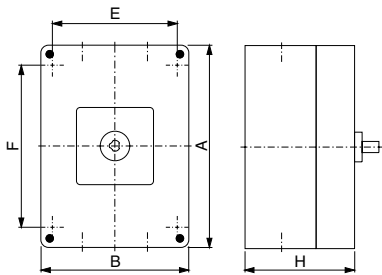

	3 and 4 pole	6 pole	A	B	E	F	H
KG20A, KG32A, KG41, KG64	x		135	92	78	110	91
			5.31	3.62	3.07	4.33	3.58
KG20B, KG32B KG41B, KG64B		x	180	140	128	150	98
			7.09	5.51	5.04	5.91	3.86
KG80, KG100	x		180	140	128	150	98
			7.09	5.51	5.04	5.91	3.86

Cam/rack-operated Auxiliary Contacts

E	VE	Mount- ing	A	M	
				allows use of 1 or 2 contacts	allows use of 3 or 4 contacts
KG20-KG105C	KG20-KG105C	KG20, KG32	E/VE	9	25,8
				.35	1.02
		KG41, KG64	E/VE	10	30
				.39	1.18
		KG80, KG100 KG105	E	10	30
	.39		1.18		
KG125-KG317	KG125-KG317	VE	47,2	30	
			1.86	1.18	
			.39	1.18	
		Mounting	M		
		KG125-KG317	E	21	.83

Lateral mounted Auxiliary Contacts

	M
KG20, KG20A, KG20B, KG32, KG32A, KG32B	10
	.39
KG41, KG41B, KG64, KG64B	11
	.43
KG80, KG80C, KG100, KG100C, KG105, KG105C	11
	.43
KG125-KG317	14
	.55

Optional Extras

Ground and Neutral Terminal, Additional Main Contact

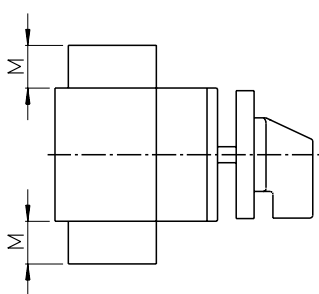

	<u>M</u>
KG20, KG20A, KG20B, KG32, KG32A, KG32B	13,5
	.53
KG41, KG41B, KG64, KG64B	16
	.63
KG80, KG80C, KG100, KG100C, KG105, KG105C	22
	.87
KG125, KG126, KG127, KG160, KG161, KG162	38
	1.50
KG210, KG211, KG212, KG250, KG251, KG252, KG315, KG316, KG317	52,5
	2.07

Protective Cover

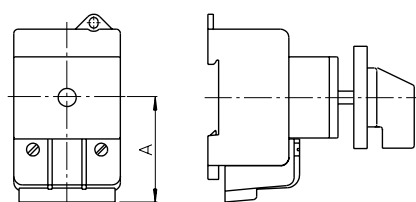

	<u>A</u>
KG10A, KG10B	30
	1.18
KG20, KG20A, KG20B, KG32, KG32A, KG32B	47
	1.85
KG41, KG41B, KG64, KG64B	49
	1.93
KG80, KG80C, KG100, KG100C, KG105, KG105C	66
	2.60

With box terminal

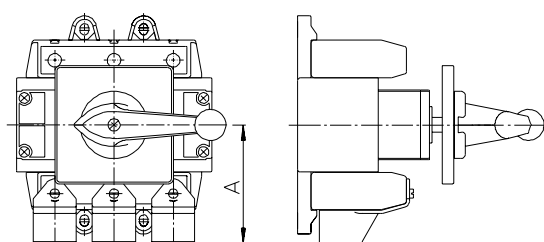

	<u>A</u>
KG125-KG162 with box terminal	76,2
	3.00
with bolt terminal	112
	4.41
KG210-KG317 with box terminal	88
	3.46
with bolt terminal	109,5
	4.29

With bolt terminal

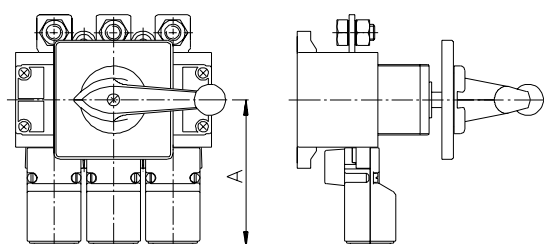

Optional Extras

Shaft Extension

L100, L100A

L1 = Free shaft length

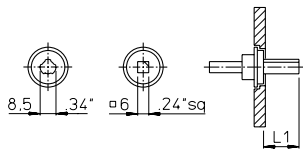

	Mounting	L1								
		L1	L1	L1	L1	L1	L1	L1	L1	L1
KG10B	E	19	23	27	32	37	42	47	52	57
	VE	.75	.91	1.06	1.26	1.46	1.65	1.85	2.05	2.24
KG20B, KG32B	E	11,5	16,5	20,5	24,5	29,5	34,5	39,5	44,5	49,5
	VE	.45	.65	.81	.96	1.16	1.36	1.56	1.75	1.95
KG41B, KG64B	E	13,5	17,5	21,5	26,5	31,5	36,5	41,5	46,5	51,5
	VE	.53	.69	.85	1.04	1.24	1.44	1.63	1.83	2.03
KG80, KG80C	E	13,5	17,5	21,5	26,5	31,5	36,5	41,5	46,5	51,5
	VE	.53	.69	.85	1.04	1.24	1.44	1.63	1.83	2.03
KG100, KG100C	E	16,5	20,5	24,5	29,5	34,5	39,5	44,5	49,5	54,5
	VE	.65	.81	.96	1.16	1.36	1.56	1.75	1.95	2.15

	Mounting	L1								
		L1	L1	L1	L1	L1	L1	L1	L1	L1
KG10B	E	62	67	72	77	82	87	92	97	102
	VE	2.44	2.64	2.83	3.03	3.23	3.43	3.62	3.82	4.02
KG20B, KG32B	E	61	66	71	76	81	86	91	96	101
	VE	2.40	2.60	2.80	2.99	3.19	3.39	3.58	3.78	3.98
KG41B, KG64B	E	54,5	59,5	64,5	69,5	74,5	79,5	84,5	89,5	94,5
	VE	2.15	2.34	2.54	2.74	2.93	3.13	3.33	3.52	3.72
KG80, KG80C	E	61	66	71	77	81	86	91	96	101
	VE	2.40	2.60	2.80	3.03	3.19	3.39	3.58	3.78	3.98
KG100, KG100C	E	56,5	61,5	66,5	71,5	76,5	81,5	86,5	91,5	96,5
	VE	2.22	2.42	2.62	2.81	3.01	3.21	3.41	3.60	3.80
KG105, KG105C	E	58,8	63,8	68,8	73,8	78,8	83,8	88,8	93,8	98,8
	VE	2.31	2.51	2.71	2.91	3.10	3.30	3.50	3.69	3.89
KG80, KG80C	E	56,5	61,5	66,5	71,5	76,5	81,5	86,5	91,5	96,5
	VE	2.22	2.42	2.62	2.81	3.01	3.21	3.41	3.60	3.80
KG100, KG100C	E	59,5	64,5	69,5	74,5	79,5	84,5	89,5	94,5	99,5
	VE	2.34	2.54	2.74	2.93	3.23	3.33	3.52	3.72	3.92

M004, M004A, M004D, M004E

L1 = Free shaft length

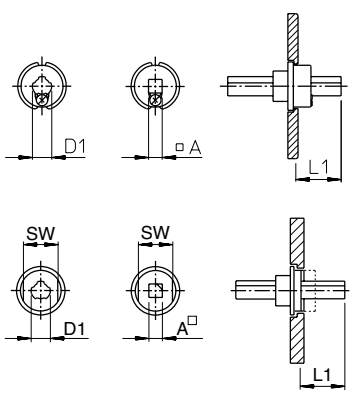

	Mounting	L1					D1	A	SW
		L1 ¹	L1	L1	L1	L1			
KG10A	E, VE	-	21-41	41-61	61-81	81-101	6	-	12
		-	.83-1.61	1.61-2.40	2.40-3.19	3.19-3.98	.24	-	.47
KG20A, KG32A	E	-	34,5-38	54,5-58	74,5-78	94,5-98	6	-	12
	VE	-	1.36-1.50	2.15-2.28	2.93-3.07	3.72-3.86	.24	-	.47
KG41B, KG64B	E	29,5-35,5	43-49	63-69	83-89	103-109	8,5	6	16
	VE	1.16-1.40	1.69-1.93	2.48-2.72	3.27-3.50	4.06-4.29	.33	.24	.63
KG80, KG80C	E	32,5-38,5	46-52	66-72	86-92	106-112	8,5	6	16
	VE	1.28-1.52	1.81-2.05	2.60-2.83	3.39-3.62	4.17-4.41	.33	.24	.63
KG100, KG100C	E	25,5-31,5	39-45	59-65	79-85	99-105	8,5	6	16
	VE	1.00-1.24	1.54-1.77	2.32-2.56	3.11-3.35	3.90-4.13	.33	.24	.63
KG105, KG105C	E	30,5-36,5	44-50	64-70	84-90	104-110	8,5	6	16
	VE	1.20-1.44	1.73-1.97	2.52-2.76	3.31-3.54	4.09-4.33	.33	.24	.63
KG125, KG126	E	39-53	69-83	99-113	129-143	159-173	11,2	8	22
	VE	1.54-2.09	2.72-3.27	3.90-4.45	5.08-5.63	6.26-6.81	.44	.32	.87
KG161, KG162	E	44-58	74-88	104-118	134-148	164-178	11,2	8	22
	VE	1.73-2.28	2.91-3.46	4.09-4.65	5.28-5.83	6.46-7.01	.44	.32	.87
KG210, KG211	E	38-52	68-82	98-112	128-142	158-172	11,2	8	22
	VE	1.50-2.03	2.68-3.23	3.86-4.41	5.04-5.59	6.22-6.77	.44	.32	.87
KG251, KG252	E	43-57	73-87	103-117	133-147	163-177	11,2	8	22
	VE	1.69-2.24	2.87-3.43	4.06-4.61	5.24-5.78	6.42-6.97	.44	.32	.87
KG315, KG316									
KG317									

¹Only for square shaft

Optional Extras

Simplified Door Clutches

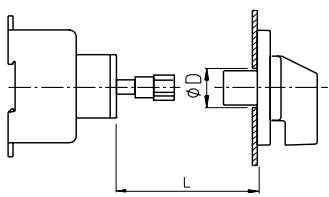

M290/A3, M290/A3.EF L = Standard length for switches of mounting VE

	L	L	L	L	L	D ¹
KG10A	37-57	57-77	77-97	97-117	-	18
	1.46-2.24	2.24-3.03	3.03-3.82	3.82-4.61	-	.71
KG20A, KG32A	55-68	75-88	95-108	115-128	-	18
	2.17-2.68	2.95-3.46	3.74-4.25	4.53-5.04	-	.71
KG41B, KG64B	60-70	80-90	100-110	120-130	-	18
	2.36-2.76	3.15-3.54	3.94-4.33	4.72-5.12	-	.71
KG80, KG100	56-68	76-88	96-108	116-128	-	18
KG105	2.20-2.68	2.99-3.46	3.78-4.25	4.57-5.04	-	.71

¹For KG10A with M290/A3.EF: 22/87

M290/A1.EF L = Standard length for switches of mounting VE

	L	L	L	L	L	D
KG41B, KG64B	27-31	27-38	32-45	41-54	47-60	56-69
	1.06-1.22	1.06-1.50	1.26-1.77	1.61-2.13	1.85-2.36	1.97-2.72
KG80, KG100	27-32	27-40	33-47	42-55	48-62	57-70
KG105	1.06-1.26	1.06-1.57	1.30-1.85	1.65-2.17	1.89-2.44	2.24-2.76

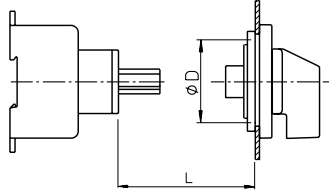

V840E

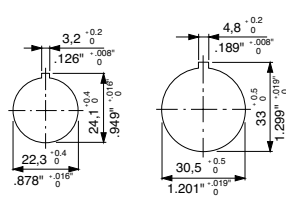
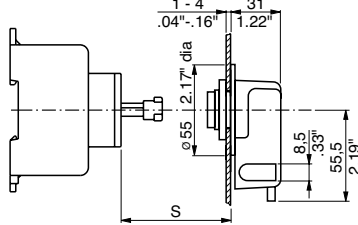

	S	
	min.	max.
KG10B	23	106
	.91	4.17
KG20B, KG32B	24,5	110
	.96	4.33
KG41B, KG64B	20	108
	.79	4.25
KG80, KG100	23	109
KG105	.91	4.29
KG125-KG317	21	110
	.83	4.33

V840G/V840F

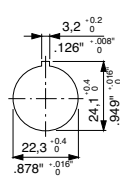
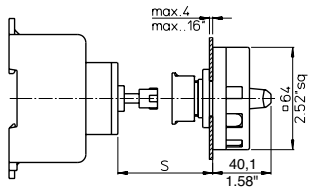

	S	
	min.	max.
KG10B	30	115
	1.02	4.49
KG20B, KG32B	27,5	113
	1.08	4.45
KG41B, KG64B	39,5	124
	1.56	4.88
KG80, KG100	27,5	122
KG105	1.08	4.80

V845

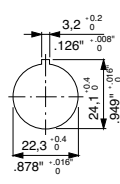
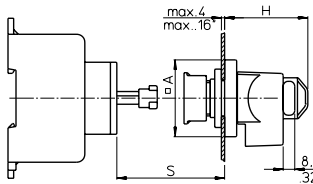

	A		H		S	
	min.	max.	min.	max.	min.	max.
KG10A	48	52	30	115		
	1.89	2.05	1.18	4.53		
KG10B	64	58	26	114		
	2.52	2.28	1.02	4.49		
KG20A, KG32A	48	52	50,5	119		
	1.89	2.05	1.99	4.69		
KG20B, KG32B	64	58	27,5	113		
	2.52	2.28	1.08	4.45		
KG41B, KG64B	64	58	39,5	124		
	2.52	2.28	1.56	4.88		
KG80, KG100	64	58	27,5	122		
KG105	2.52	2.28	1.08	4.80		

M600

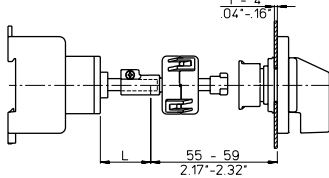

L see L100, M004D, M004, page 42.

Door Clutches

M700/.

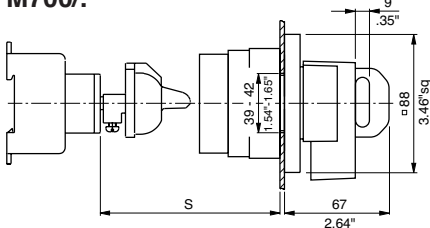

M701

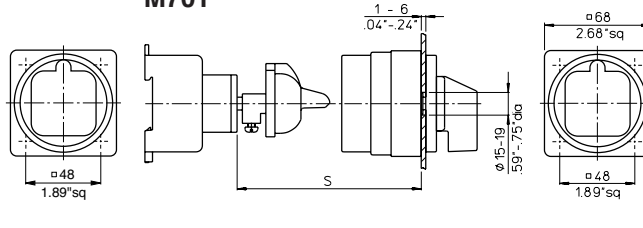

	S
KG10B	80
	3.15
KG20B, KG32B	61,5
	2.42
KG41B, KG64B	61,5
	2.42
KG80, KG100	61,5
KG105	2.42
KG125-KG317	61,5
	2.42

Optional Extras

Door Clutches

KG10A, KG20A, KG32A

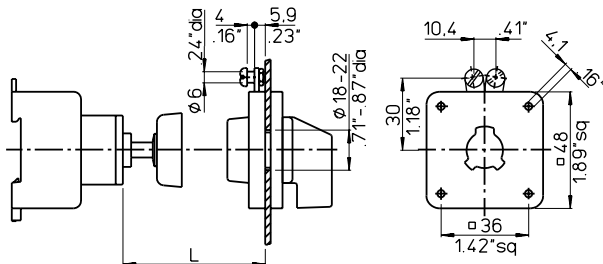

M280D, M280D/.EF, M280E, M280E/.EF

L = Standard length for switches of mounting VE

	L	L	L	L
KG10A	36-55 1.42-2.17	56-75 2.20-2.95	75-95 2.99-3.74	96-116 3.78-4.57
KG20A, KG32A	58,5-66 2.30-2.60	78,5-86 3.09-3.50	98,5-106 3.88-4.17	118,5-126 4.67-4.96

KG10B, KG20B, KG32B, KG41B, KG64B, KG80, KG100, KG105

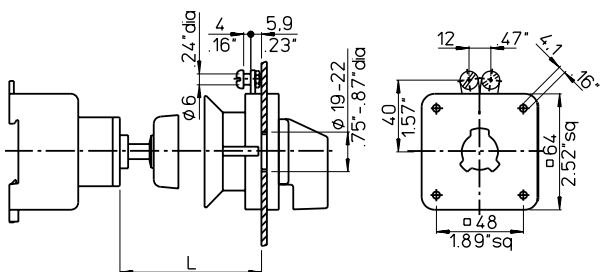

	L	L	L	L
KG10B	32-57 1.26-2.24	58-77 2.28-3.03	78-97 3.07-3.82	98-118 3.86-4.65
KG20B, KG32B	57,5-65 2.26-2.56	77,5-85 3.05-3.35	97,5-105 3.84-4.13	117,5-125 4.63-4.92
KG41B, KG64B	62-72 2.44-2.83	82-92 3.23-3.62	102-112 4.02-4.41	122-132 4.80-5.20
KG80, KG100 KG105	60-70 2.36-2.76	80-90 3.15-3.54	100-110 3.94-4.33	120-130 4.72-5.12

KG125-KG317

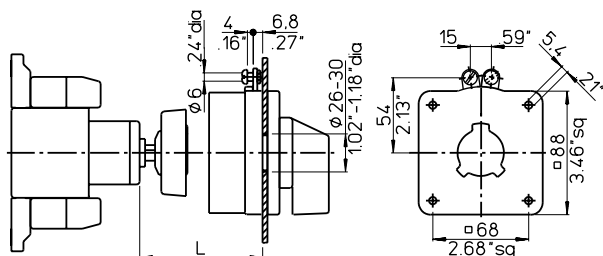

	L	L	L	L
KG125-KG317	93-109 3.66-4.29	123-139 4.84-5.47	153-169 6.02-6.65	183-199 7.20-7.83

KG41, KG64

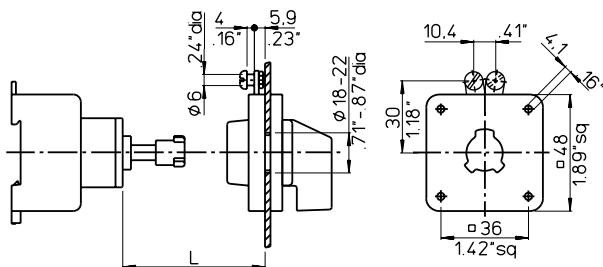

M280B/., M280B/.EF

L = Standard length for switches of mounting VE

	L	L	L	L
KG41, KG64	26-34 1.02-1.34	41-49 1.61-1.93	56-64 2.20-2.52	71-79 2.80-3.11

Optional Extras

Padlock Devices, Additional Module for Motor Control Center (MCC)

V840A

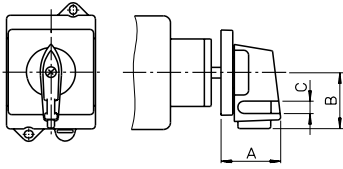

	A	B	C
KG10A, KG20A, KG32A, KG41	32,9	31,5	5
KG64	1.30	1.24	.20
KG10B, KG20B, KG32B, KG41B	41,6	40	7
KG64B, KG80, KG100, KG105	1.64	1.57	.28

V840B

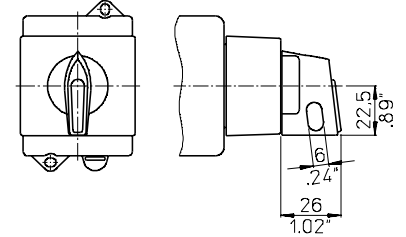

V845

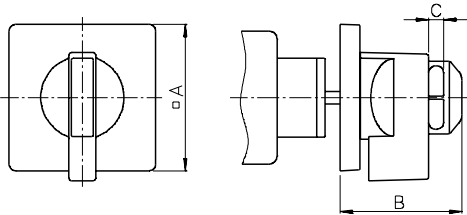

	A	B	C
KG10A, KG20A, KG32A, KG41	48	51	7,2
KG64	1.89	2.01	.28
KG10B, KG20B, KG32B, KG41B	64	58	8,1
KG64B, KG80, KG100, KG105	2.52	2.28	.32
KG80C, KG100C, KG105C	88	73	9
KG125-KG317	3.47	2.87	.35

V840D

KG10A, KG20A, KG32A, KG41, KG64

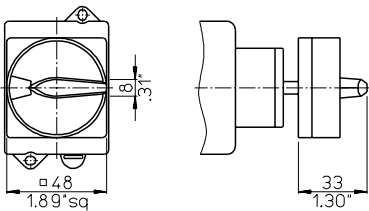

V840D

KG80C, KG100C, KG105C, KG125-KG162

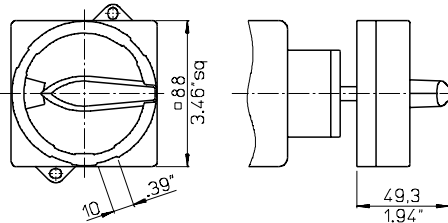

V840G/B, V840F/B

KG10B, KG20B, KG32B, KG41B, KG64B, KG80, KG100, KG105

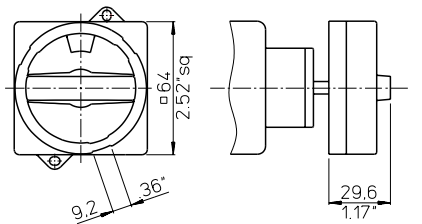

V840G, V840F/F

KG10B, KG20B, KG32B, KG41B, KG64B, KG80, KG100, KG105

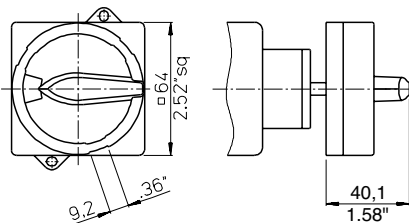

V840H/..E

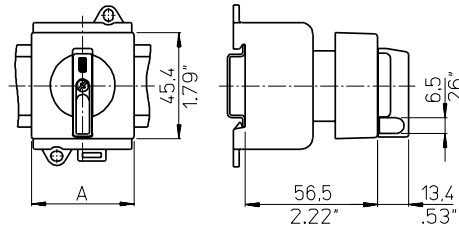

	A
KG20A, KG32A	43,7
	1.72
KG41, KG64	52,4
	2.06

V840VE

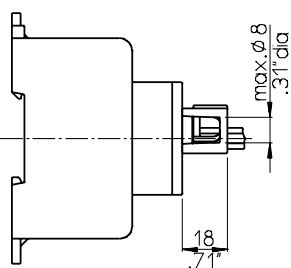

V500

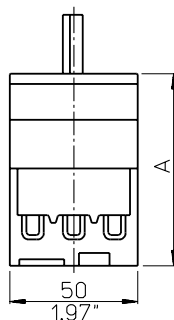

	A
KG20/32B	69,5
	2.74
KG41/64B	75
	2.95

M330

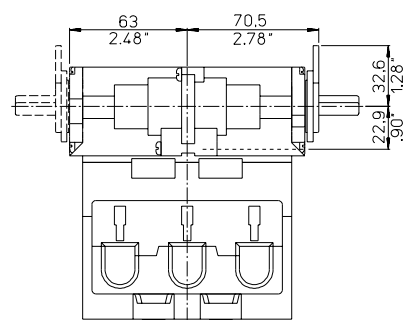

Mounting

(Additional length for auxiliary contacts see page 48)

ON/OFF Switches 4 pole

E

	A	B	C	D1	D2 ¹	E	F	G	H	L
KH16-KHR25	48	36	4	10-15	5/3,5	30	12,2	60	56	49
	1.89	1.42	.16	.39-.59	.20/.14	1.18	.48	2.36	2.20	1.93
KH16B-KHR25B	64	48	4	10-15	5/3,5	30	12,2	60	56	49
	2.52	1.89	.16	.39-.59	.20/.14	1.18	.48	2.36	2.20	1.93
KH32, KHR32, KH40, KHR40	64	48	4	10-15	5/3,5	30	12,2	70	62	54
	2.52	1.89	.16	.39-.59	.20/.14	1.18	.48	2.76	2.44	2.13
KH63, KHR63	64	48	4	10-15	5/3,5	37	14	86	90	62
KH80, KHR80	2.52	1.89	.16	.39-.59	.20/.14	1.46	.55	3.39	3.54	2.44

¹Dimensions after the slash are valid for two hole panel mounting

**FT2
FH3**

	A	G	H	L
KH16-KHR25	49	60	56	63,5
	1.93	2.36	2.20	2.50
KH32, KHR32, KH40, KHR40	64	70	62	68,7
	2.52	2.76	2.44	2.70
KH63, KHR63,	64	86	90	77,1
KH80, KHR80	2.52	3.39	3.54	3.04

VE

	A	B	C	D1	D2	D3	E	F	G	H	L
KH16-KHR25	48	36	12	8-15	5	4,2	60	22	60	56	47
	1.89	1.42	.47	.31-.59	.20	.17	2.36	.86	2.36	2.20	1.85
KH16B-KHR25B	64	48	13,5	10-15	5	4,2	60	22	60	56	47
	2.52	1.89	.53	.39-.59	.20	.17	2.36	.86	2.36	2.20	1.47
KH32, KHR32, KH40, KHR40	64	48	25,5	10-15	5	4,1	70	25	70	62	53,5
	2.52	1.89	1.00	.39-.59	.20	.16	2.76	.98	2.76	2.44	2.11
KH63, KHR63, KH80, KHR80	64	48	25,5	10-15	5	4,1	90	25	86	90	59,5
	2.52	1.89	1.00	.39-.59	.20	.16	3.54	.98	3.39	3.54	2.34

VE2

	A	B	G	L
KH16-KHR25	43,7	45,4	60	53,5
	1.72	1.79	2.36	2.11
KH32, KHR32	70,4	45,4	70	54,7
KH40, KHR40	2.77	1.79	2.76	2.15
KH63, KHR63	70,4	45,4	86	61,7
KH80, KHR80	2.77	1.79	3.39	2.43

Mounting

(Additional length for auxiliary contacts see page 48)

ON/OFF Switches 8 pole and Double-throw Switches

E

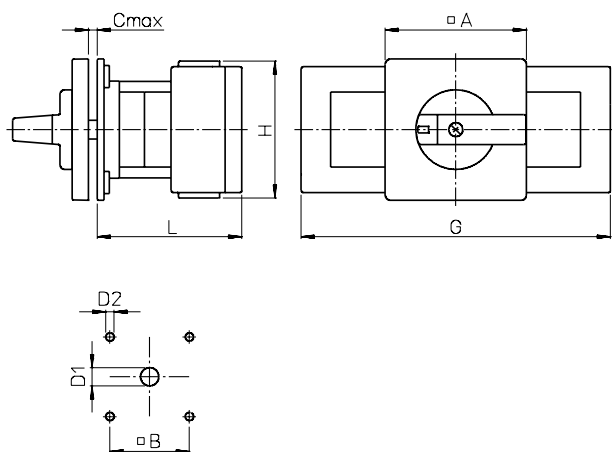

	A	B	C	D1	D2	G	H	L
KH32, KHR32	64	48	4	10-15	5	140,1	62	65,4
KH40, KHR40	2.52	1.89	.16	.39-.59	.20	5.52	2.44	2.57

VE

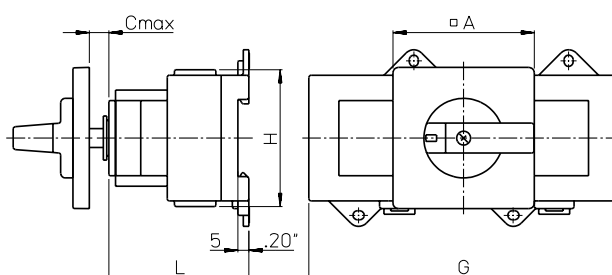

	A	C	G	H	L
KH32, KHR32	64	13,5	140,1	62	63,4
KH40, KHR40	2.52	.53	5.52	2.44	2.50

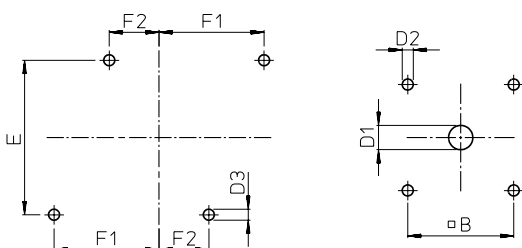

	B	D1	D2	D3	E	F1	F2
KH32, KHR32	64	10-15	5	4,1	70	47,5	22,5
KH40, KHR40	2.52	.39-.59	.20	.16	2.76	1.87	.89

VE2

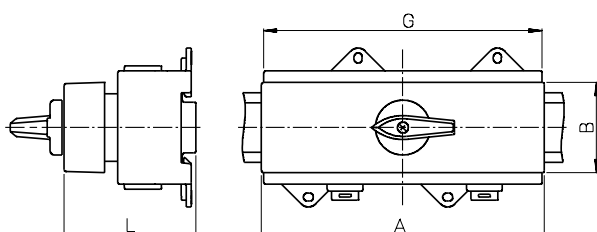

	A	B	G	L
KH32, KHR32	142,4	45,4	140,1	59
KH40, KHR40	5.61	1.79	5.52	2.32

Optional Extras

Protective Cover

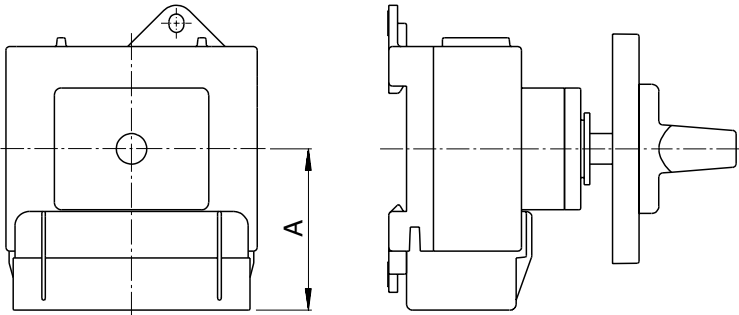

	<u>A</u>
KH32-KHR40	45
	1.77
KH63-KHR80	68,5
	2.70

Cam/rack-operated Auxiliary Contacts

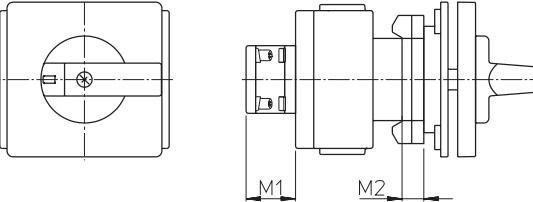
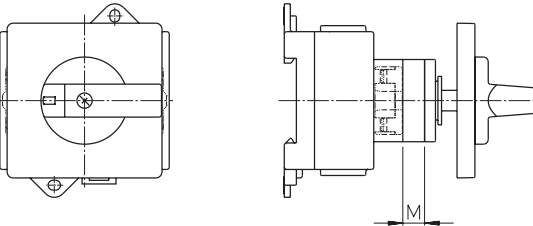
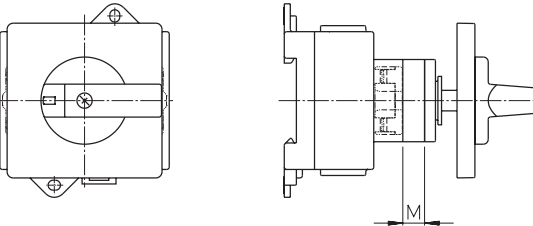
E 	KH16-KHR25B	1 or 2 contacts	<u>M</u>	<u>M1</u>	<u>M2</u>		
			9	-	9		
			.35	-	.35		
		3 or 4 contacts	25,8	-	25,8		
			1.02		1.02		
VE 	KH32, KHR32, KH40, KHR40	1 or 2 contacts	0	20,5	-		
			.81				
		3 or 4 contacts	0	32,5	-		
				1.28			
VE 	KH63, KHR63, KH80, KHR80	1 or 2 contacts	0	18,5	-		
			.73				
		3 or 4 contacts	0	30,5	-		
				1.20			

Lateral mounted Auxiliary Contacts

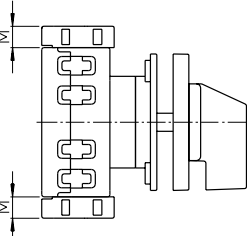
	KH16-KHR25B	<u>M</u>
		10
		.39
	KH32, KHR32, KH40, KHR40	10
		.39
	KH63, KHR63, KH80, KHR80	10
.39		

Ground Terminal

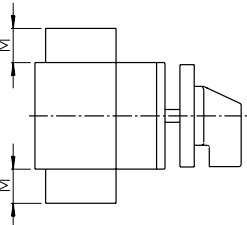
	KH16-KHR25B	<u>M</u>
		13,5
		.53
	KH32, KHR32, KH40, KHR40	13,5
		.53
	KH63, KHR63, KH80, KHR80	20
.79		

Optional Extras

Switches in Plastic Enclosure

KL..., CL..., KS..., CS..

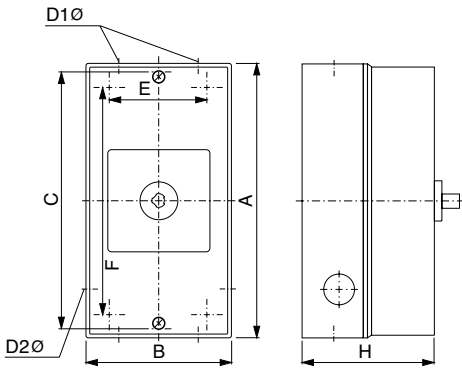

	A	B	C	D1	D2	E	F	H
KH16, KHR16	120	85	110	2x20	20	-	-	80
	4.72	3.35	4.33	2x.79	.79	-	-	3.15
KH20, KHR20	120	85	110	2x25	20	-	-	80
	4.72	3.35	4.33	2x.98	.79	-	-	3.15
KH25, KHR25	160	85	150	2x25	20	-	-	80
	6.30	3.35	5.91	2x.98	.79	-	-	3.15
KH32, KHR32	190	100	178	2x25	25	-	-	91
	7.48	3.94	7.01	2x.98	.98	-	-	3.58
KH40, KHR40	190	100	178	2x25	25	-	-	91
	7.48	3.94	7.01	2x.98	.98	-	-	3.58
KH63, KHR63	250	145	-	2x40	25	124	229	107
	9.84	5.71	-	2x1.57	.98	4.88	9.02	4.21
KH80, KHR80	250	145	-	2x40	25	124	229	107
	9.84	5.71	-	2x1.57	.98	4.88	9.02	4.21

Shaft Extension

L100, L100A

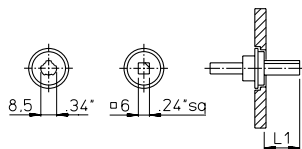

L1 = Free shaft length

	Mounting	L1	L1	L1	L1	L1	L1	L1	L1	L1	L1	L1	L1	L1	L1	L1	L1	L1	
KH16B-KHR25B	E	11,5	16,5	20,5	24,5	29,5	34,5	39,5	44,5	49,5	54,5	59,5	64,5	69,5	74,5	79,5	84,5	89,5	94,5
		.45	.65	.81	.96	1.16	1.36	1.56	1.75	1.95	2.15	2.34	2.54	2.74	2.93	3.13	3.33	3.52	3.72
	VE	18	23	27	31	36	41	46	51	56	61	66	71	77	81	86	91	96	101
		.71	.91	1.06	1.22	1.42	1.61	1.81	2.01	2.20	2.40	2.60	2.80	3.03	3.19	3.39	3.58	3.78	3.98
KH32, KHR32, KH40, KHR40, KH63, KHR63, KH80, KHR80	E	14,3	18,3	22,3	27,3	32,3	37,3	42,3	47,3	52,3	57,3	62,3	67,3	72,3	77,3	82,3	87,3	92,3	97,3
		.56	.72	.88	1.07	1.27	1.47	1.67	1.86	2.06	2.26	2.45	2.65	2.85	3.04	3.24	3.44	3.63	3.83
	VE	19,8	23,8	27,8	32,8	37,8	42,8	47,8	52,8	57,8	62,8	67,8	72,8	77,8	82,8	87,8	92,8	97,8	102,8
		.78	.94	1.09	1.29	1.49	1.69	1.88	2.09	2.28	2.47	2.67	2.87	3.06	3.26	3.46	3.65	3.85	4.05

M004D, M004E

M004, M004A

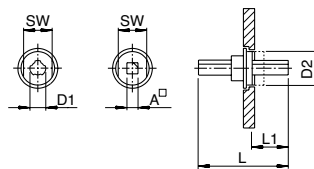
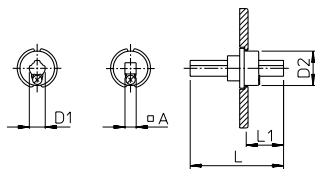

L = Shaft length
L1 = Free shaft length max.
1 = Only for square shaft

	Mounting	L ¹	L ¹	L	L ¹	L	L ¹	L	L ¹	L	L ¹	D1	D2	A	SW
KH16-KHR25	E	-	-	60	11-38	80	31-58	100	51-78	120	71-98	6	13.8	-	12
				2.36	.43-1.50	3.15	1.22-2.28	3.94	2.01-3.07	4.72	2.80-3.86	.24	.54		.47
	VE	-	-	60	18-45	80	38-65	100	58-85	120	78-105	6	13.8	-	12
				2.36	.71-1.77	3.15	1.50-2.56	3.94	2.28-3.35	4.72	3.07-4.13	.24	.54		.47
KH32, KHR32, KH40, KHR40, KH63, KHR63, KH80, KHR80	E	56,5	3-36	70	17-49	90	37-69	110	57-89	130	77-109	8,5	18,5	6	16
		2.22	.12-1.42	2.76	.67-1.93	3.54	1.46-2.72	4.33	2.24-3.50	5.12	3.03-4.29	.34	.73	.24	.63
	VE	56,5	8-41	70	22-55	90	42-75	110	62-95	130	82-115	8,5	18,5	6	16
		2.22	.31-1.61	2.76	.87-2.17	3.54	1.65-2.95	4.33	2.44-3.74	5.12	3.23-4.53	.34	.73	.24	.63

Optional Extras

Simplified Door Clutches

M290/A3, M290/A3.EF

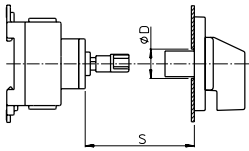

S = Standard length for switches of mounting VE

	S	S	S	S	D
KH16-KHR25	34,5-61,5 1.36-2.42	54,5-81,5 2.15-3.21	74,5-101,5 2.93-4.00	94,5-121,5 3.72-4.78	18 .71
KH32, KHR32, KH40, KHR40, KH63, KHR63, KH80, KHR80	28-55 1.10-2.17	55-75 2.17-2.95	75-95 2.95-3.74	95-115 3.74-4.53	18 .71

M290/A1.EF

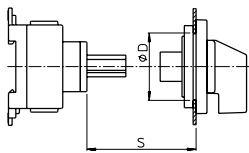

S = Standard length for switches of mounting VE

	S	S	S	S	S	S	D
KH32, KHR32, KH40, KHR40, KH63, KHR63, KH80, KHR80	25-30 .98-1.18	27-37 1.06-1.46	34-44 1.34-1.73	42-52 1.65-2.05	49-59 1.93-2.32	57-67 2.24-2.64	45,6 1.80

V840E

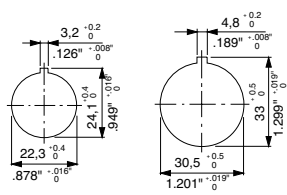
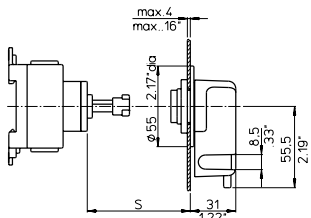

	S _{min.}	S _{max.}
KH16B-KHR25B	24,5 .96	110 4.33
KH32, KHR32, KH40, KHR40, KH63, KHR63, KH80, KHR80	20 .79	120 4.72

V840G/V840F

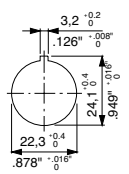
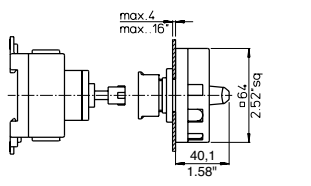

	S _{min.}	S _{max.}
KH16B-KHR25B	27,5 1.08	113 4.45
KH32, KHR32, KH40, KHR40, KH63, KHR63, KH80, KHR80	28 1.10	124 4.88

V845

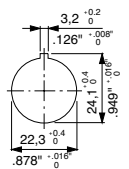
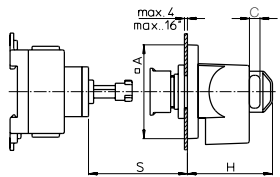

	A	C	H	S _{min.}	S _{max.}
KH16-KHR25	48 1.89	7,2 .28	52 2.05	29,5 1.16	119 4.69
KH16B-KHR25B	64 2.52	8,1 .32	58 2.28	27,5 1.08	113 4.45
KH32, KHR32, KH40, KHR40, KH63, KHR63, KH80, KHR80	64 2.52	8,1 .32	58 2.28	28 1.10	124 4.88

M600

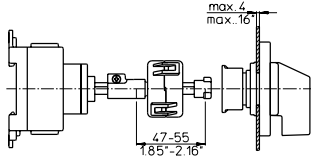

Door Clutches

M700/.

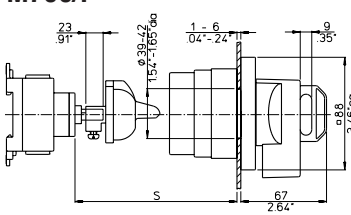

M701

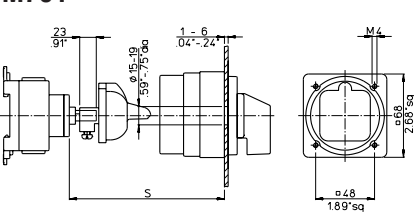

	S _{min.}	
	L100	M004D, M004
KH16B-KHR25B	61,5 2.42	-
KH32, KHR32, KH40, KHR40, KH63, KHR63, KH80, KHR80	61,5 2.42	68 2.68

Optional Extras

Door Clutches

M280D, M280D/.EF, M280E, M280E/.EF

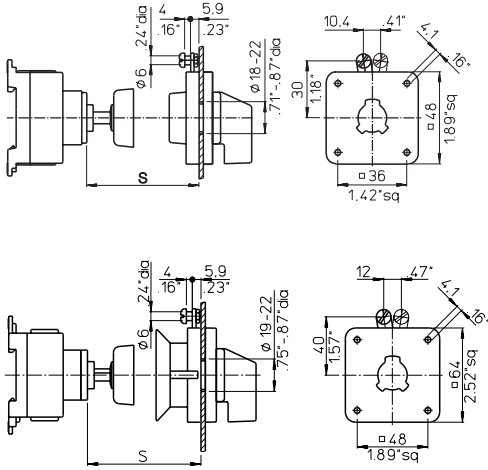

S = Standard length for switches of mounting VE

	S	S	S	S
KH16-KHR25	35-60 1.38-2.36	60-80 2.36-3.15	80-100 3.15-3.94	100-120 3.94-4.72

	S	S	S	S
KH16B-KHR25B	37-64 1.46-2.52	64-84 2.52-3.31	84-104 3.31-4.09	104-124 4.09-4.88
KH32, KHR32, KH40, KHR40, KH63, KHR63, KH80, KHR80	32-57 1.26-2.24	57-77 2.24-3.03	77-97 3.03-3.82	97-117 3.82-4.61

Padlock Devices

V840D

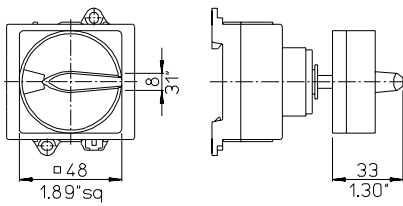

V840G, V840F/F

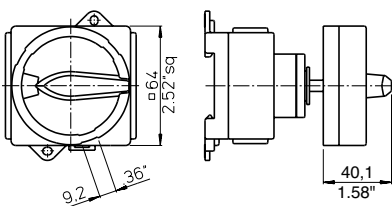

V840G/B, V840F/B

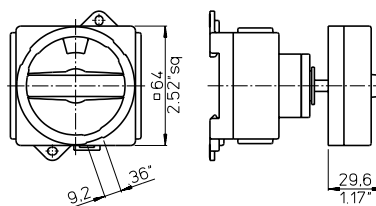

V840A

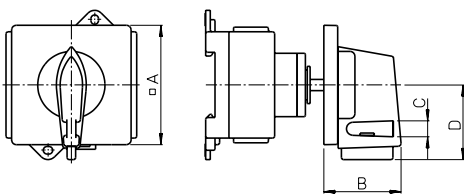

	A	B	C	D
KH16-KHR25	48 1.89	32,9 1.30	5 .20	31,5 1.24
KH16B-KHR25B	64 2.52	41,6 1.64	7 .28	40 1.57
KH32, KHR32, KH40, KHR40, KH63, KHR63, KH80, KHR80	64 2.52	41,6 1.64	7 .28	40 1.57

V845

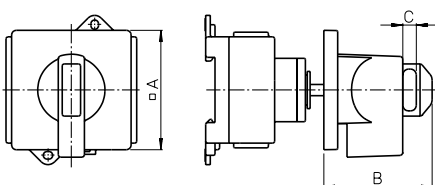

	A	B	C
KH16-KHR25	48 1.89	51 2.01	7,2 .28
KH16B-KHR25B	64 2.52	58 2.28	8,1 .32
KH32, KHR32, KH40, KHR40, KH63, KHR63, KH80, KHR80	64 2.52	58 2.28	7,2 .28

The Range of “Blue Line” Switchgear

Technical literature covering the following products is available on request.

	Catalog Number
Main Switches and Main Switches with Emergency Function 16 A-315 A Maintenance Switches 20 A-315 A Switch Disconnectors 20 A-315 A According to IEC 60947-3, EN 60947-3, VDE 0660 part 107, IEC 60204, EN 60204 and VDE 0113	500
CL Switches 10 A-20 A C, CA and CAD Switches 10 A-315 A and L Switches 350 A-2400 A C, CA and CAD switches are designed for universal application. They are recommended for instrument, isolator, double-throw and motor control. L switches are designed for load and off-load applications. They are used to switch resistive or low inductive loads.	100
Optional Extras and Enclosures The complete product line, a large number of optional extras is available, including door interlocks, push-pull devices, cylinder and padlock attachments, control and indicator devices, AC motor drives, as well as enclosures, both insulated and metal.	101
A and AD Switches 6 A-25 A A and AD switches have 4 contacts in each switching stage. These switches provide an extensive range of switch functions and require a minimum mounting depth. Up to 36 switching positions are possible, with availability of 48 contacts per 12 stage switch column.	110
CG, CH and CHR Switches 10 A-25 A Ultra compact CG, CH and CHR switches are ideally suited for control and instrumentation applications. Terminals are conveniently accessible for wiring and are delivered open. All CG4 switches offer specially designed gold plated contacts or H-bridges with “cross-wire” contact systems, which facilitates their use in electronic circuitry and chemically aggressive environments.	120
DH, DHR, DK and DKR Switches 6 A-16 A DH, DHR, DK and DKR switches incorporate unique corrosion resistant contacts that permit operation on system voltage as low as 1 V. They have fully enclosed and protected contacts which can be operated either by rotary and/or lateral handle movement. D switches are used in calibration and semiconductor circuits. They are also used for relay and contactor control.	130
X Switches 80 A-630 A X switches can be applied for load, tap and gang switching duties. They incorporate 6 contacts in each switching stage. Their compact design provides a minimum length dimension for mounting purposes.	140
KG Switches 20 A-315 A and KH and KHR Switches 16 A-80 A KG, KH and KHR switches are excellent circuit interruptors. They have high through fault and fault making capacities and are especially designed for use as isolators and safety switches for machine tools, distribution panels and switchboards. KG ON/OFF switches offer unusually high dimensioned air and creepage distances between terminals which are designed for time saving “straight-line” wiring. ON/OFF switches are available with up to 8 poles and double-throw switches are available with up to 4 poles.	150
Contactors 16 A-115 A and Motor Starters 1,1 kW-55 kW These include control relays, motor contactors, two and four pole output contactors, heating contactors, thermal overload relays.	200
Push Buttons and Pilot Lights, 22,5 mm Ø A complete range of state-of-the-art push buttons and pilot lights represent an ideal combination of functional security and economical efficiency in a modular design.	302

