













- (H) *Fényforrások***
 - (CZ) *Světelné zdroje***
 - (SK) *Svetelné zdroje***
 - (RO) *Surse de lumină***
 - (YU) *Izvori svetlosti***
 - (MAC) *Светлосни тела***
 - (BG) *Източници на светлина***
 - (EST) *Valgusallikad***
 - (LV) *Gaismas avoti***
 - (LT) *Šviesos šaltiniai***
-

Jelmagyarázat ● Legenda ● Legenda
Legendă ● Legenda ● Легенда ● Легенда
Seletused ● Apzīmējumi ● Апрашумас

<p>Type</p> <p>Típus Typ Typ Тір Тір Вид Тип</p> <p>Nimetus Tips Tipas</p>	<p>Cd</p> <p>Fényerősség (cd) Svítivost (cd) Svietivost' (cd)</p> <p>Intensitate luminoasă (cd) Vršni intenzitet (cd) Светлосна сила (кд) Светлина интензивност (кд)</p> <p>Valgustugevus (cd) Gaismas intensitāte (cd) Šviesos stiprumas (cd)</p>	<p>Fig.</p> <p>Ábraszám Obrázek Obrázok</p> <p>Fig. Sl. Сл. Рис.</p> <p>Joonis Zim. Pav.</p>
<p>W</p> <p>Watt Watt Príkon (W)</p> <p>Wați Watt Ват Ват</p> <p>Võimsus (W) Vati Vatai</p>	<p></p> <p>Sugárzási szög (°) Úhel záření (°) Uhol vyžarovania (°)</p> <p>Unghi de radiație (°) Širina snopa (°) Ширина на снопа (°) Ширина на снопа (°)</p> <p>Valgusjaotuse (°) Gaismas leņķis (°) Spindulys (°)</p>	<p>SKU</p> <p>Termékkód Kód výrobku Kód výrobku</p> <p>Cod produs Šifra proizvoda Ознака на кодот од производител Продукткод</p> <p>Tootekood Produkta kods Gaminio kodas</p>
<p>V</p> <p>Volt Volt Napätie (V)</p> <p>Volți Volt Волт Волт</p> <p>Pinge (V) Volti Voltai</p>	<p>LCL</p> <p>Fénypontmagasság (mm) Výška světelného středu (mm) Výška svetelného stredu (mm)</p> <p>Înălțimea punctului luminos (mm) Visina svetlosne tačke (mm) Висина на светлосната точка (мм) Височина на светлинната точка (мм)</p> <p>Valguspunktaugus (mm) Gaismas centra augstums (mm) Šviesos šaltinio aukštis (mm)</p>	<p>EAN</p> <p>EAN-kód EAN kód EAN kód</p> <p>Cod EAN EAN kod EAN код EAN-код</p> <p>EAN kood EAN kods EAN kodas</p>
<p>A</p> <p>Amper Amper Prúd (A)</p> <p>Amperaj Amper Ампер Ампер</p> <p>Voolutugevus (A) Ampéri Amperai</p>	<p>CCT</p> <p>Színhőmérséklet (K) Náhradní teplota chromatičnosti (K) Teplota chromatičnosti (K)</p> <p>Temperatura de culoare (K) Temp. boje (K) Темп. на светлоста (K) Цветна темп. (K)</p> <p>Várvustemp. (K) Krásas temp. (K) Spalvinė temp. (K)</p>	<p>Égetési helyzet ● Provozní poloha ● Prevádzková poloha Pozíția de funcționare ● Radni položaj sijalice ● Работна положба на сијалицата Работно положение на лампата Tõõsend ● Nostiprināšanas stāvoklis ● Degimo padėtis</p>
<p></p> <p>Fej Patice Pătica</p> <p>Soclu Podnožje Навој Цокъл</p> <p>Sokkel Cokols Cokolis</p>	<p>Ra</p> <p>Színvisszaadási index Index barevného podání Index podania farieb</p> <p>Indice de redare a culorii Indeks prezentacije boja Индекс за претставените бои Индекс на цветоотдавање</p> <p>Vārviedastus indekss Krāsas atveides indekss Spalvų atkūrimo koeficientas</p>	<p>  ± 60°</p> <p>Tetszőleges Libovolná Lubovolná</p> <p>Arbitrară Svaki Било која Произволно</p> <p>Universaalne Jebkurš Bet kuri</p> <p>Vízszintes ± 60° Vodorovná ± 60° Vodorovná ± 60° Orizontală ± 60° Horizontalni ± 60° Хоризонтална ± 60° Хоризонтално ± 60° Horizontaalne ± 60° Horizontalis ± 60° Horizontali ± 60°</p>
<p>L_{max.}</p> <p>A lámpa max. hossza (mm) Maximální délka (mm) Maximálna dl'žka svet. zdroja (mm)</p> <p>Lungime maximă (mm) Maksimalna dužina (mm) Максимална должина (мм) Макс. дължина на лампата (мм)</p> <p>Suurim pikkus (mm) Maksimālais garums (mm) Maksimalus ilgis (mm)</p>	<p>t_(h)</p> <p>Élettartam (óra) Životnost (hod.) Život (hod.)</p> <p>Durată (h) Vek trajanja (h) Времетраење (ч.) Време на живот (ч.)</p> <p>Tõõiga (h) Kalpošanas laiks (h) Tarnavimo laikas (h)</p>	<p> ± 4°  ± 75°</p> <p>Vízszintes ± 4° Vodorovná ± 4° Vodorovná ± 4° Orizontală ± 4° Horizontalni ± 4° Хоризонтална ± 4° Хоризонтално ± 4° Horizontaalne ± 4° Horizontalis ± 4° Horizontali ± 4°</p> <p>Vízszintes ± 75° Vodorovná ± 75° Vodorovná ± 75° Orizontală ± 75° Horizontalni ± 75° Хоризонтална ± 75° Хоризонтално ± 75° Horizontaalne ± 75° Horizontalis ± 75° Horizontali ± 75°</p>
<p>∅</p> <p>Lámpaátmérő (mm) Průměr (mm) Priemer (mm)</p> <p>Diametru (mm) Diametar (mm) Диаметар (мм) Диаметър на лампата (мм)</p> <p>Lābimērots (mm) Diametrs (mm) Skersmuo (mm)</p>	<p></p> <p>Csomagolás (db) Balení (ks) Balenie (ks)</p> <p>Ambalare Pakovanje (kom.) Транспортно пакување Опаковка</p> <p>Pakend (tk) Iepakojums (gab.) Kiekis pakuotėje</p>	<p> ± 20°  ± 45°</p> <p>Vízszintes ± 20° Vodorovná ± 20° Vodorovná ± 20° Orizontală ± 20° Horizontalni ± 20° Хоризонтална ± 20° Хоризонтално ± 20° Horizontaalne ± 20° Horizontalis ± 20° Horizontali ± 20°</p> <p>Függőleges, fej fent ± 45° Svislá, patice nahore ± 45° Zvislá, pătica hore ± 45° Verticală, cu soclu sus ± 45° Vertikalni, sa podnožjem na gore ± 45° Вертикален, со навојот кон горе ± 45° Вертикално, с наклон нагоре ± 45° Vertikaalne, sokkel üleval ± 45° Vertikāls, ar cokolu uz augšu ± 45° Vertikali, cokolis viršuje ± 45°</p>
<p>lm</p> <p>Fényáram (lumen) Světelný tok (lm) Svetelný tok (lm)</p> <p>Flux luminos (lm) Svetlosni fluks (lm) Светлосен сноп (лм) Светлинен поток (лм)</p> <p>Valgusvoog (lm) Gaismas plūsma (lm) Šviesos srautas (lm)</p>	<p>EEC</p> <p>Energiatárhékonysági osztály Třída energetické účinnosti Trieda energetickej účinnosti</p> <p>Clasa de eficiență energetică Klasa energetske efikasnosti Класа на енергетска ефикасност Клас на енергийна ефективност</p> <p>Energiaklass Enerģijas izmantošanas efektivitātes klase Enerģijos efektyvumo klasė</p>	<p> ± 45°  ± 30°</p> <p>Vízszintes ± 45° Vodorovná ± 45° Vodorovná ± 45° Orizontală ± 45° Horizontalni ± 45° Хоризонтална ± 45° Хоризонтално ± 45° Horizontaalne ± 45° Horizontalis ± 45° Horizontali ± 45°</p> <p>Függőleges, fej fent ± 30° Svislá, patice nahore ± 30° Zvislá, pătica hore ± 30° Verticală, cu soclu sus ± 30° Vertikalni, sa podnožjem na gore ± 30° Вертикален, со навојот кон горе ± 30° Вертикално, с наклон нагоре ± 30° Vertikaalne, sokkel üleval ± 30° Vertikāls, ar cokolu uz augšu ± 30° Vertikali, cokolis viršuje ± 30°</p>

Tartalomjegyzék • Obsah • Obsah

Cuprins • Sadržaj • Содржина • Съдържание

Sisukord • Saturs • Turinys

Izzólámpák

Žárovky

Žiarovky

Lămpi cu incandescentă

Inkadescentne sijalice

Сијалици со влакно

Лампи с нажежаема жичка

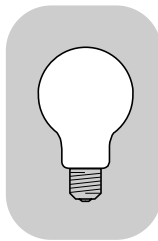

Nagyintenzitású kisülőlámpák

Vysokotlaké výbojky

Vysokotlakové výbojky

Lămpi cu descărcare la înaltă presiune

Sijalice visokog pritiska sa pražnjenjem

Сијалици со висок притисок и со празнење

Газоразрядни лампи с високо налягане

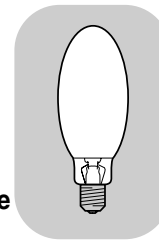

Hőõglambid

Kvêlspuldzes

Kaitrinês lemputês

Lahenduslambid

Augstas intensitātes gāzizlādes spuldzes

Didelio intensyvumo išlydžio lempos

Halogénlámpák

Halogenové žárovky

Halogénové žiarovky

Lămpi halogene

Halogene sijalice

Халогени сијалици

Халогенни лампи

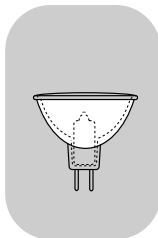

Különleges csomagolások

Speciální balení

Zvláštne balenia

Alte împachetări

Posebna pakovanja

Специјална пакувања

Специјални опаковки

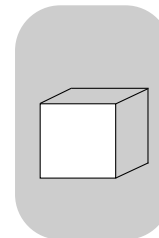

Halogeenlambid

Halogênspludzes

Halogeninês lemputês

Eripakendid

Spuldzes speciālā iepakojumā

Specialios pakuotės

Fénycsövek

Zářivky

Žiarivky

Tuburi fluorescente

Fluorescentne cevi

Флуоресцентни цевки

Луминисцентни тръби

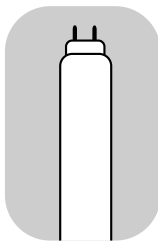

Luminestsentslambid

Fluorescences spuldzes

Fluorescinês lempos

Kompakt fénycsövek

Kompaktní zářivky

Kompaktné žiarivky

Lămpi fluorescente compacte

Kompakt fluorescentne sijalice

Компакт флуоресцентни сијалици

Компактни луминисцентни лампи

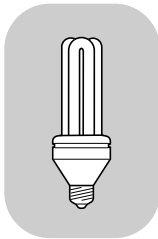

Kompaktluminestsentslambid

Kompaktās fluorescences spuldzes

Компактишкос fluorescencinês lempos

Normállámpák
Žárovky obyčejné
Žiarovky obyčajné

Lámpa normale
Standardne sijalice
Стандартни сијалици
Стандартни лампи

Standardlambid
Parastās kvēlspuldzes
Standartinēs lemputēs

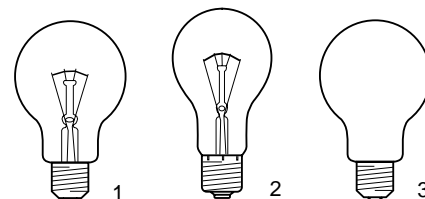

W	V		L _{max.}	Ø	lm	t _(h)		EEC	Fig.	SKU	EAN
---	---	--	-------------------	---	----	------------------	--	-----	------	-----	-----

világos ● čirá ● číra ● clar ● bistra ● просирна ● прозрочна ● klaar ● caurspīdīga ● skaidrus

15	230	E27	105,5	60	90	1000	1/10/100	F	1	508148	9004100025216
	240	E27	105,5	60	90	1000	1/10/100	F	1	510608	9004100025810
25	230	E27	105,5	60	230	1000	1/10/100	E	1	508149	9004100091013
	240	E27	105,5	60	225	1000	1/10/100	E	1	508140	9004100035710
40	230	E27	105,5	60	415	1000	1/10/100	E	1	508150	9004100094717
	240	E27	105,5	60	410	1000	1/10/100	E	1	508141	9004100097718
60	230	E27	105,5	60	710	1000	1/10/100	E	1	508151	9004100152516
	240	E27	105,5	60	700	1000	1/10/100	E	1	508142	9004100155715
75	230	E27	105,5	60	940	1000	1/10/100	E	1	508152	9004100175416
	240	E27	105,5	60	930	1000	1/10/100	E	1	508144	9004100177410
100	230	E27	105,5	60	1340	1000	1/10/100	E	1	508153	9004100188515
	240	E27	105,5	60	1330	1000	1/10/100	E	1	508143	9004100190716
150	230	E27	118	68	2160	1000	1/10/50	E	1	508111	9004100368917
	240	E27	118	68	2140	1000	1/10/50	E	1	508110	9004100369815
200	230	E27	144	80	3040	1000	1/25	E	1	508107	9004100350912
	240	E27	144	80	2990	1000	1/25	E	1	508106	9004100351612
300	230	E27	174	90	4850	1000	1/16	E	1	508104	9004101600818
300	230	E40	188	90	4850	1000	1/16	E	2	508108	9004100337814

belülhomályosított ● matovaná ● matovaná ● mat ● matirana ● матирана ● матова ● matt ● matēta ● matinis

15	230	E27	105,5	60	90	1000	1/10/100	F	3	510609	9004100026817
	240	E27	105,5	60	90	1000	1/10/100	F	3	510610	9004100027418
25	230	E27	105,5	60	230	1000	1/10/100	E	3	508154	9004100037011
	240	E27	105,5	60	225	1000	1/10/100	E	3	510540	9004100091518
40	230	E27	105,5	60	415	1000	1/10/100	E	3	508155	9004100138817
	240	E27	105,5	60	410	1000	1/10/100	E	3	510541	9004100142913
60	230	E27	105,5	60	710	1000	1/10/100	E	3	508156	9004100160115
	240	E27	105,5	60	700	1000	1/10/100	E	3	508145	9004100164311
75	230	E27	105,5	60	940	1000	1/10/100	E	3	508157	9004101601013
	240	E27	105,5	60	930	1000	1/10/100	E	3	508146	9004100182414
100	230	E27	105,5	60	1340	1000	1/10/100	E	3	508158	9004100194219
	240	E27	105,5	60	1330	1000	1/10/100	E	3	508147	9004100196718
150	230	E27	118	68	2160	1000	1/10/50	E	3	508109	9004100370514
	240	E27	118	68	2140	1000	1/10/50	E	3	510439	9004100371412
200	230	E27	144	80	3040	1000	1/25	E	3	508105	9004100352916
	240	E27	144	80	2990	1000	1/25	E	3	510440	9004100353715

TUNGSRASOFT l mp k
 arovky TUNGSRASOFT
 iarovky TUNGSRASOFT

L mpi TUNGSRASOFT
TUNGSRASOFT sijalice
TUNGSRASOFT si alicy
TUNGSRASOFT lampi

TUNGSRASOFT lambid
TUNGSRASOFT spuldzes
TUNGSRASOFT lempu s

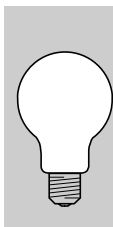
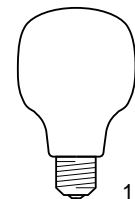

W	V		L _{max.}	�	lm	t _(h)		EEC	Fig.	SKU	EAN
---	---	--	-------------------	---	----	------------------	--	-----	------	-----	-----

op l ● opalizovaná ● opalizovaná ● opal ● mle na ● mle na ● onal ● opaal ● op ls ● opalinis

25	230	E27	105,5	60	200	1000	1/10/100	F	1	509633	9004100264516
40	230	E27	105,5	60	360	1000	1/10/100	F	1	509634	9004100265216
	240	E27	105,5	60	355	1000	1/10/100	F	1	510603	9004100266114
60	230	E27	105,5	60	620	1000	1/10/100	F	1	509638	9004100266411
	240	E27	105,5	60	610	1000	1/10/100	F	1	510602	9004100267210
75	230	E27	105,5	60	820	1000	1/10/100	F	1	509635	9004100267319
	240	E27	105,5	60	810	1000	1/10/100	F	1	510601	9004100267913
100	230	E27	105,5	60	1165	1000	1/10/100	F	1	509636	9004100268118
	240	E27	105,5	60	1155	1000	1/10/100	F	1	510600	9004100268811



ENRICH l mp k
 arovky ENRICH
 iarovky ENRICH

L mpi ENRICH
ENRICH sijalice
ENRICH si alicy
ENRICH lampi

ENRICH lambid
ENRICH spuldzes
ENRICH lempu s

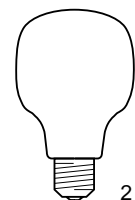

40	230	E27	105,5	60	300	1000	2/20/40	G	2	91752	0043168917520
60	230	E27	105,5	60	510	1000	2/20/40	G	2	91753	0043168917537
100	230	E27	105,5	60	960	1000	2/20/40	G	2	91754	0043168917544



COMPUTER LIGHT l mp k
 arovky COMPUTER LIGHT
 iarovky COMPUTER LIGHT

L mpi COMPUTER LIGHT
COMPUTER LIGHT sijalice
COMPUTER LIGHT si alicy
COMPUTER LIGHT lampi

COMPUTER LIGHT lambid
COMPUTER LIGHT spuldzes
COMPUTER LIGHT lempu s

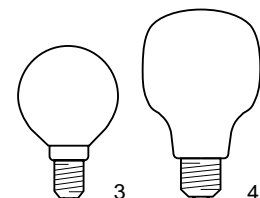

40	230	E14	79	45	360	1000	1/10/50	F	3	91766	0043168917667
40	230	E27	105,5	60	400	1000	1/10/50	E	4	91762	0043168917629
60	230	E27	105,5	60	680	1000	1/10/50	E	2	91763	0043168917636



Színes normállámpák
Žárovky obyčejné barevné
Obyčajné farebné žiarovky

Lámpa normale colorate
Standardne sijalice u boji
Стандартни обоени сијалици
Стандартни цветни лампи

Värvilised standardlambid
Krāsainās kvēlspuldzes
Spalvotos standartinēs lemputēs

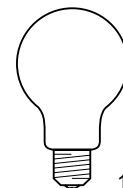
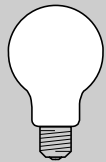

W	V		L _{max.}	Ø	lm	t _(h)		EEC	Fig.	SKU	EAN
piros ● červená ● červená ● rožu ● crvena ● црвена ● червена ● punane ● sarkana ● raudona											
15	230	E27	105,5	60	–	1000	1/10/50	–	1	510467	9004100028910
25	230	E27	105,5	60	–	1000	1/10/100	–	1	508120	9004100041018
40	230	E27	105,5	60	–	1000	1/10/100	–	1	508115	9004100049212
	240	E27	105,5	60	–	1000	1/10/50	–		510472	9004100049519
narancssárga ● oranžová ● oranžová ● portocaliu ● narandžasta ● помаранџеста ● оранџева ● oranz ● orandža ● oranžinė											
25	230	E27	105,5	60	–	1000	1/10/100	–	1	508118	9004100044217
40	230	E27	105,5	60	–	1000	1/10/100	–	1	510468	9004100051611
sárga ● žltá ● žltá ● galben ● žuta ● жолта ● жълта ● kollane ● dzeltena ● geltona											
15	230	E27	105,5	60	–	1000	1/10/50	–	1	510466	9004100030012
25	230	E27	105,5	60	–	1000	1/10/100	–	1	508119	9004100042619
40	230	E27	105,5	60	–	1000	1/10/100	–	1	508114	9004100050614
	240	E27	105,5	60	–	1000	1/10/50	–	1	510471	9004100050911
zöld ● zelená ● zelená ● verde ● zelena ● зелена ● зелена ● roheline ● žala ● žalia											
25	230	E27	105,5	60	–	1000	1/10/100	–	1	508116	9004100047416
40	230	E27	105,5	60	–	1000	1/10/100	–	1	508112	9004100057712
	240	E27	105,5	60	–	1000	1/10/50	–	1	510469	9004100058412
kék ● modrá ● modrá ● albastru ● plava ● плава ● синя ● sinine ● žila ● mėlyna											
15	230	E27	105,5	60	–	1000	1/10/50	–	1	510465	9004100032016
25	230	E27	105,5	60	–	1000	1/10/100	–	1	508117	9004100045610
40	230	E27	105,5	60	–	1000	1/10/100	–	1	508113	9004100056210
	240	E27	105,5	60	–	1000	1/10/50	–	1	510470	9004100056814

Kisfeszültségű normállámpák
Žárovky obyčejné pro malé napětí
Obyčajné žiarovky na malé napätia

Lámpa normale cu funcționare la tensiune redusă
Niskonaponske standardne sijalice
Нисконапонски стандардни сијалици
Стандартни лампи с ниско напрежение

Madalapinge standardlambid
Zemsprieguma standarta spuldzes
Žemos įtampos standartinės lemputės

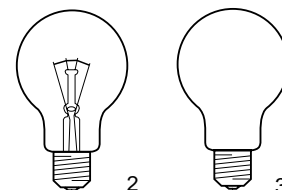

W	V		L _{max.}	Ø	lm	t _(h)		EEC	Fig.	SKU	EAN
világos ● čirá ● čira ● clar ● bistra ● просирна ● прозрaчнa ● klaar ● caurspīdīga ● skaidrus											
25	24	E27	105,5	60	320	1000	1/10/100	C	2	508160	9004100090016
40	24	E27	105,5	60	580	1000	1/10/100	D	2	508161	9004100092317
	42	E27	105,5	60	520	1000	1/10/100	D	2	510613	9004100093017
60	24	E27	105,5	60	930	1000	1/10/100	D	2	508162	9004100149615
	36	E27	105,5	60	880	1000	1/10/100	D	2	510612	9004100150017
	42	E27	105,5	60	860	1000	1/10/100	D	2	508163	9004100150314
75	24	E27	105,5	60	1200	1000	1/10/100	D	2	508164	9004100174112
100	24	E27	105,5	60	1740	1000	1/10/100	D	2	508165	9004100185613
	42	E27	105,5	60	1600	1000	1/10/100	D	2	510611	9004100186214
belülhomályosított ● matovaná ● matovaná ● mat ● matirana ● матирана ● матова ● matt ● matēta ● matinis											
40	24	E27	105,5	60	580	1000	1/10/100	D	3	510616	9004100099019
60	24	E27	105,5	60	930	1000	1/10/100	D	3	510615	9004100157214
100	24	E27	105,5	60	1740	1000	1/10/100	D	3	510614	9004100192116

Nappali fényű NATURLUX lámpák
Žárovky NATURLUX
Žiarovky NATURLUX (vylepšené podanie farieb)

Lámpa NATURLUX
NATURLUX sijalice
NATURLUX сијалици со дневна светлина
NATURLUX лампи с дневна светлина

NATURLUX spulzės
Стандардни сијалицини
NATURLUX lempütés

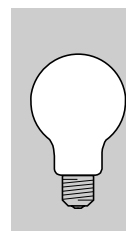
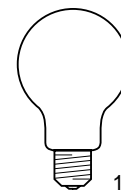

W	V		L _{max.}	∅	lm	t _(h)		EEC	Fig.	SKU	EAN
---	---	--	-------------------	---	----	------------------	--	-----	------	-----	-----

különleges kék színű ● speciální modrá ● speciálna modrá ● de culoare albastră specială ● poseban plavi premaz
 посебно обоена во плаво ● цветна в специално синьо ● erilise sinise värvusega ● speciāli zili krāsota ● specialus mėlynas

60	230	E27	105,5	60	300	1000	1/10/50	G	1	510476	9004100168517
100	230	E27	118	68	500	1000	1/10/50	G	1	510473	9004100364216



WEEK-END (ANTI INSECT) lámpák
Žárovky WEEK-END (proti hmyzu)
Žiarovky WEEK-END (proti hmyzu)

Lámpa WEEK-END (ANTI INSECT)
WEEK-END (ANTI-INSECT) sijalice
WEEK-END (против инсекти) сијалици
WEEK-END (ANTI INSECT) лампи

WEEK-END (putukaid mittemeelitavad) lambid
WEEK-END spulzės (nepiesaista kukaiņus)
WEEK-END (neviliojančios vabzdžių) lempütés

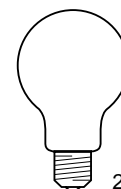

különleges sárga színű ● speciální žlutá ● speciálna žltá ● de culoare galbenă specială ● poseban žuti premaz
 посебно обоена во жолто ● цветна в специално жълто ● erilise kollase värvusega ● speciāli dzeltenī krāsota ● specialus geltonas

60	230	E27	105,5	60	200	1000	1/10/50	G	2	91129	0043168479868
100	230	E27	105,5	60	450	1000	1/10/50	G	2	91727	0043168479844



RESISTA (rázásálló) lámpák
Žárovky otřesuvzdorné RESISTA
Otrasuvzdorné žiarovky RESISTA

Lámpa RESISTA (rezistente la vibrații)
RESISTA sijalice za otežane uslove eksploatacije
RESISTA сијалици за работа во отежнати услови
RESISTA лампи за utežnени условия на експлоатация

RESISTA (põrutuskindlad) lambid
RESISTA spulzės (izturīgas pret vibrācijām)
RESISTA (atsparios smūgiams) lempütés

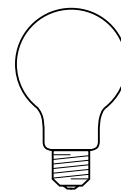
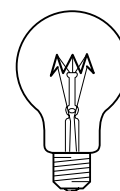

világos ● čirá ● čira ● clar ● bistra ● просирна ● прозрачна ● klaar ● caurspīdīga ● skaidrus

60	230	E27	105,5	60	500	1000	1/100	G	3	508103	9004100440118
	240	E27	105,5	60	500	1000	1/100	G	3	508102	9004100440910
100	230	E27	105,5	60	1000	1000	1/20	G	3	510446	9004100442815
	240	E27	105,5	60	1000	1000	1/10/100	G	3	508101	9004100443218



belülhomályosított ● matovaná ● matovaná ● mat ● matirana ● матирана ● матова ● matt ● matēta ● matinis

60	230	E27	105,5	60	450	2500	1/20	G	4	510447	9004100446417
	240	E27	105,5	60	450	1000	1/20	G	4	510449	9004100442013
100	240	E27	105,5	60	880	1000	1/20	G	4	510448	9004100444512

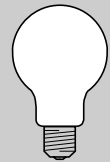

Közlekedési jelzőlámpák

Žárovky pro dopravní signalizaci

Žiarovky pre dopravnú signalizáciu

Lămpi pentru semnalizoare de circulație

Sijalice za saobraćajnu signalizaciju

Сијалици за сообраќајна сигнализација

Лампи за транспортна сигнализација

Valgusfoori lambid

Spuldzes luksoforiem

Šviesoforu lemputės

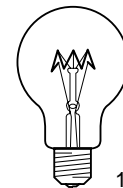

W	V		L _{max.}	∅	lm	t _(h)		EEC	Fig.	SKU	EAN
---	---	--	-------------------	---	----	------------------	--	-----	------	-----	-----

világos ● čirá ● čira ● clara ● bistra ● просирна ● прозрочна ● klaar ● caurspīdīga ● skaidrus

60	240	E27	105,5	60	380	3000	1/10/100	G	1	35239	0043168352390
100	240	E27	118	68	830	3000	1/10/100	G	1	35246	0043168352468



Tetõtükros lămpák

Žárovky se zrcadlovým vrchlíkem

Žiarovky so zrkadlovým vrchlíkom

Lămpi cu calotă oglindată

Sijalice sa posrebrnim ili pozlaćenim vrhom

Сијалици посребрени на врвот

Лампи с посребрен и позлатен върх

Peegeipeaga lambid

Spoguļvirsmas spuldzes

Lempuťės su veidrodiniu kupolu

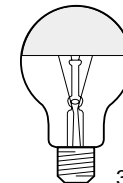

világos, ezüstszínű buratetővel ● čirá, s vrchlíkem stříbrné barvy ● čira, s vrchlíkom striebranej farby

clar, cu calotă de oglindă argintată ● bistra, sa posrebrnim vrhom ● просирна, со посребрен врв ● прозрочна, с посребрен върх

klaar, pealt hõbedase peegliiga ● caurspīdīga, ar sudrabotu spoguļvirsmu ● skaidrus, viršus su sidabrinu veidrodžiu

25		230	E14	79	45	160	1000	1/10/50	G	2	90553	5994102330736
40		230	E14	79	45	260	1000	1/10/50	G	2	90552	5994102330873
40		230	E27	105,5	60	290	1000	1/10/50	G	3	510480	9004100147611
60		230	E27	105,5	60	500	1000	1/10/50	G	3	510479	9004100170411
100		230	E27	105,5	60	1000	1000	1/10/50	G	3	510478	9004100365411

világos, aranyszínű buratetővel ● čirá, s vrchlíkem zlaté barvy ● čira, s vrchlíkom zlatej farby

clar, cu calotă de oglindă aurie ● bistra, sa pozlaćenim vrhom ● просирна, со златен врв ● прозрочна, с позлатен върх

klaar, pealt kuldse peegliiga ● caurspīdīga, ar zeltitu spoguļvirsmu ● skaidrus, viršus su auksiniu veidrodžiu

40		230	E14	79	45	230	1000	1/10/100	G	2	90557	9004102290315
40		230	E27	105,5	60	260	1000	1/10/50	G	3	91135	0043168333290
60		230	E27	105,5	60	450	1000	1/10/50	G	3	91136	0043168479851



Kriptonlámpák
Žárovky kryptonové
Kryptónové žiarovky

Lámpy cu Krypton
Kriptonske sijalice
Криптонски сијалици
Криптонови лампи

Krüpton lambid
Kriptonspuldzes
Kriptoninés lempütés

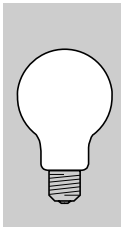
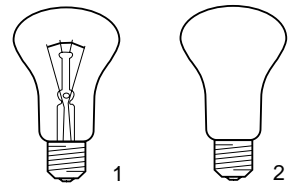

W	V		L _{max.}	Ø	lm	t _(h)		EEC	Fig.	SKU	EAN
---	---	--	-------------------	---	----	------------------	--	-----	------	-----	-----

világos ● čirá ● číra ● clar ● bistra ● просирна ● прозрочна ● klaar ● caurspidiga ● skaidrus											
60	230	E27	92	50	730	1000	1/10/100	E	1	509673	9004100285818
75	230	E27	99	55	965	1000	1/10/100	E	1	509675	9004100292311
100	230	E27	99	55	1380	1000	1/10/100	E	1	509677	9004100297811

belülhomályosított ● matovaná ● matovaná ● mat ● matirana ● матирана ● матова ● matt ● matēta ● matinis											
40	230	E27	92	50	425	1000	1/10/100	E	2	510572	9004100281018
60	230	E27	92	50	730	1000	1/10/100	E	2	509674	9004100286815
75	230	E27	99	55	965	1000	1/10/100	E	2	509676	9004100293219
100	230	E27	99	55	1380	1000	1/10/100	E	2	509678	9004100298610



SUPERBA

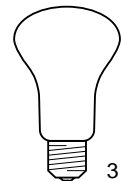

opál ● opalizovaná ● opalizovaná ● opal ● mlečna ● млечна ● опал ● opaal ● opāls ● opalinis											
40	230	E27	92	50	380	1000	1/10/100	F	3	509680	9004100282411
	240	E27	92	50	380	1000	1/10/100	F	3	510571	9004100283012
60	230	E27	92	50	655	1000	1/10/100	E	3	509682	9004100288512
	240	E27	92	50	655	1000	1/10/100	E	3	510570	9004100289212
75	230	E27	99	55	865	1000	1/10/100	E	3	509684	9004100294414
	240	E27	99	55	865	1000	1/10/100	E	3	510569	9004100295015
100	230	E27	99	55	1200	1000	1/10/100	F	3	509686	9004100299815
	240	E27	99	55	1200	1000	1/10/100	F	3	510568	9004100313719



SUPERBALUX

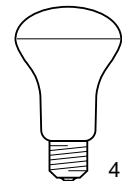

opalizált, szatinírozott buratetővel ● opalizovaná, se satinovaným vrchlíkem ● opalizovaná so satinovaným vrchlíkom opal, sacapul balonului satinat ● mlečna sa satenskim vrhom ● млечна со сатенизиран врв ● опализирана със сатиниран върх opaal, ots matt ● opāls ar satinizētu virsmu ● opalinis, viršus matinis											
25	230	E27	92	50	215	1000	1/10/100	E	4	509679	9004100278810
	240	E27	92	50	215	1000	1/10/100	E	4	510581	9004100279510
40	230	E27	92	50	390	1000	1/10/100	E	4	509681	9004100284415
	240	E27	92	50	390	1000	1/10/100	E	4	510580	9004100285412
60	230	E27	92	50	700	1000	1/10/100	E	4	509683	9004100290812
	240	E27	92	50	700	1000	1/10/100	E	4	510579	9004100291710
75	230	E27	99	55	880	1000	1/10/100	E	4	509685	9004100296418
	240	E27	99	55	880	1000	1/10/100	E	4	510577	9004100297316
100	230	E27	99	55	1320	1000	1/10/100	E	4	509687	9004100315317
	240	E27	99	55	1320	1000	1/10/100	E	4	510576	9004100316116



Dekorációs gömblámpák
Žárovky iluminační
Dekoratívne guľkové žiarovky

Lāmpi decorative sferice
Dekoratívne okrúgle sijalice
Декоративни тркалезни сијалици
Декоративни сферични лампи

Dekoriativlambid
Dekorativās spuldzes
Dekoratyvinės rutulinės lemputės

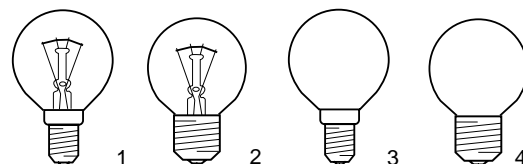
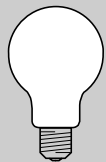

W	V		L _{max.}	∅	lm	t _(h)		EEC	Fig.	SKU	EAN
---	---	--	-------------------	---	----	------------------	--	-----	------	-----	-----

világos ● čirá ● čira ● clar ● bistra ● просирна ● прозрачна ● klaar ● caurspīdīga ● skaidrus

15	230	E14	79	45	90	1000	1/10/100	F	1	508091	9004101613214
25	230	E14	79	45	200	1000	1/10/100	F	1	508084	9004100616315
	240	E14	79	45	200	1000	1/10/100	F	1	510333	9004100617718
40	230	E14	79	45	400	1000	1/10/100	E	1	508086	9004100623511
	240	E14	79	45	400	1000	1/10/100	E	1	508087	9004100625218
60	230	E14	79	45	660	1000	1/10/100	E	1	508089	9004100630717
15	230	E27	74	45	90	1000	1/10/100	F	2	508099	9004100465319
25	230	E27	74	45	200	1000	1/10/100	F	2	508092	9004100634616
	240	E27	74	45	200	1000	1/10/100	F	2	510323	9004100635415
40	230	E27	74	45	400	1000	1/10/100	E	2	508094	9004100641010
	240	E27	74	45	400	1000	1/10/100	E	2	508095	9004100642116
60	230	E27	74	45	660	1000	1/10/100	E	2	508097	9004100647111
	240	E27	74	45	660	1000	1/10/100	E	2	510342	9004100647913

belūhomālyosītott ● matovaná ● matovaná ● mat ● matirana ● матирана ● матова ● matt ● matēta ● matinis

15	230	E14	79	45	90	1000	1/10/100	F	3	510340	9004100456812
25	230	E14	79	45	200	1000	1/10/100	F	3	508085	9004100618913
	240	E14	79	45	200	1000	1/10/100	F	3	510334	9004100620619
40	230	E14	79	45	400	1000	1/10/100	E	3	508088	9004100626314
	240	E14	79	45	400	1000	1/10/100	E	3	510336	9004100628011
60	230	E14	79	45	660	1000	1/10/100	E	3	508090	9004100632315
15	230	E27	74	45	90	1000	1/10/100	F	4	508100	9004100466019
25	230	E27	74	45	200	1000	1/10/100	F	4	508093	9004100636313
	240	E27	74	45	200	1000	1/10/100	F	4	510324	9004100637617
40	230	E27	74	45	400	1000	1/10/100	E	4	508096	9004100643212
	240	E27	74	45	400	1000	1/10/100	E	4	510331	9004100644516
60	230	E27	74	45	660	1000	1/10/100	E	4	508098	9004100648217
	240	E27	74	45	660	1000	1/10/100	E	4	510343	9004100648811

opál ● opalizovaná ● opalizovaná ● opal ● mlečna ● млечна ● опал ● opaal ● opāls ● opalinis

15	220/230	E14	79	45	80	1000	1/10/100	F	3	510339	9004100457710
25	220/230	E14	79	45	180	1000	1/10/100	F	3	509775	9004100621517
40	220/230	E14	79	45	360	1000	1/10/100	F	3	509774	9004100629018
	240	E14	79	45	360	1000	1/10/100	F	3	510337	9004100630311
60	220/230	E14	79	45	600	1000	1/10/100	F	3	508175	9004100633411
15	220/230	E27	74	45	80	1000	1/10/100	F	4	510291	9004100466910
25	220/230	E27	74	45	180	1000	1/10/100	F	4	508176	9004100638713
	240	E27	74	45	180	1000	1/10/100	F	4	510390	9004100639710
40	220/230	E27	74	45	360	1000	1/10/100	F	4	508177	9004100645216
	240	E27	74	45	360	1000	1/10/100	F	4	510391	9004100646213

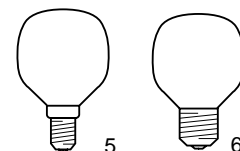

TUNGSRASOFT-ILLU

opál ● opalizovaná ● opalizovaná ● opal ● mlečna ● млечна ● опал ● opaal ● opāls ● opalinis

25	230	E14	79	45	175	1000	1/10/100	F	5	508178	9004101722015
40	230	E14	79	45	350	1000	1/10/100	F	5	508179	9004101727010
25	230	E27	74	45	175	1000	1/10/100	F	6	508180	9004101738917
40	230	E27	74	45	350	1000	1/10/100	F	6	508181	9004101742815

Színes dekorációs gömblámpák
 Žárovky iluminační barevné
 Dekorativne guličkové farebné žiarovky

Lāmpi decorative sferice colorate
 Dekorativne okrugle sijalice u boji
 Обоени декоративни тркалезни сијалици
 Цветни декоративни сферични лампи

Vārvilised dekoratiivlambid
 Krāsainās dekoratīvās spuldzes
 Spalvotos dekoratyvinės rutulinės lemputės

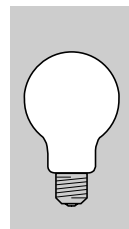
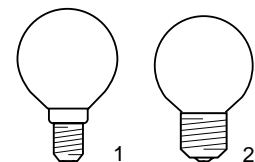

W	V		L _{max.}	∅	lm	t _(h)		EEC	Fig.	SKU	EAN
---	---	--	-------------------	---	----	------------------	--	-----	------	-----	-----

piros ● červená ● červená ● roșu ● crvena ● црвена ● червена ● punane ● sarkana ● raudona

15	230	E27	74	45	–	1000	1/10/100	–	2	510310	9004100467412
25	230/240	E14	79	45	–	1000	1/50	–	1	28315	5994102283157
25	230/240	E27	74	45	–	1000	1/50	–	2	28312	5994102283126
25	240	E27	74	45	–	1000	1/10/100	–	2	510326	9004100470313

narancssárga ● oranžová ● oranžová ● portocaliu ● narandžasta ● помаранџеста ● оранџева ● oranz ● orandža ● oranžine

15	230	E27	74	45	–	1000	1/10/100	–	2	510872	9004100468310
----	-----	-----	----	----	---	------	----------	---	---	--------	---------------

sárga ● žlutá ● žltá ● galben ● žuta ● жолта ● жълта ● kollane ● dzeltena ● geltona

15	230	E27	74	45	–	1000	1/10/100	–	2	510311	9004100467818
25	230/240	E14	79	45	–	1000	1/50	–	1	28324	5994102283249
25	230/240	E27	74	45	–	1000	1/50	–	2	28320	5994102283201
25	240	E27	74	45	–	1000	1/10/100	–	2	510327	9004100470917

zöld ● zelená ● zelená ● verde ● zelena ● зелена ● зелена ● roheline ● zala ● žalia

15	230	E27	74	45	–	1000	1/10/100	–	2	510309	9004100469010
25	230/240	E14	79	45	–	1000	1/50	–	1	28334	5994102283348
25	230/240	E27	74	45	–	1000	1/50	–	2	28331	5994102283317
25	240	E27	74	45	–	1000	1/10/100	–	2	510325	9004100473116

kék ● modrá ● modrá ● albastru ● plava ● плава ● синя ● sinine ● zila ● mėlyna

15	230	E27	74	45	–	1000	1/10/100	–	2	510308	9004100468617
25	230/240	E14	79	45	–	1000	1/50	–	1	28343	5994102283430
25	230/240	E27	74	45	–	1000	1/50	–	2	28339	5994102283393
25	240	E27	74	45	–	1000	1/10/100	–	2	510289	9004100472416



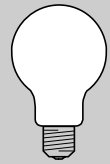

Gyertyalámpák
Žárovky svíčkové
Sviečkové žiarovky

Lămpi lumânare
Sveća sijalice
Свеќа сијалици
Лампи-свещ

Küünallambid
Svečveida spuldzes
Lemputēs-žvakutēs

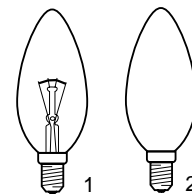

W	V		L _{max.}	∅	lm	t _(h)		EEC	Fig.	SKU	EAN
világos ● čirá ● čira ● clar ● bistra ● просирна ● прозрачна ● klaar ● caurspidīga ● skaidrus											
15	230	E14	100	35	90	1000	1/10/100	F	1	508131	9004100518411
25	230	E14	100	35	200	1000	1/10/100	F	1	508132	9004100532516
	240	E14	100	35	200	1000	1/10/100	F	1	508133	9004100534114
40	230	E14	100	35	400	1000	1/10/100	E	1	508135	9004100540115
	240	E14	100	35	400	1000	1/10/100	E	1	508136	9004100541716
60	230	E14	100	35	660	1000	1/10/100	E	1	508138	9004100549019
	240	E14	100	35	660	1000	1/10/100	E	1	510256	9004100550213
belülhomályosított ● matovaná ● matovaná ● mat ● matirana ● матирана ● матова ● matt ● matēta ● matinis											
15	240	E14	100	35	90	1000	1/10/100	F	2	510257	9004100520711
25	230	E14	100	35	200	1000	1/10/100	F	2	508134	9004100535319
	240	E14	100	35	200	1000	1/10/100	F	2	510240	9004100537115
40	230	E14	100	35	400	1000	1/10/100	E	2	508137	9004100543314
	240	E14	100	35	400	1000	1/10/100	E	2	510238	9004100545516
60	230	E14	100	35	660	1000	1/10/100	E	2	508139	9004100551517
	240	E14	100	35	660	1000	1/10/100	E	2	510237	9004100552910
opál ● opalizovaná ● opalizovaná ● opal ● mlečna ● млечна ● онал ● opaal ● opāls ● opalinis											
15	230	E14	100	35	90	1000	1/10/100	F	2	509597	5994100068914
25	230	E14	100	35	200	1000	1/10/100	F	2	509594	9004100538112
	240	E14	100	35	200	1000	1/10/100	F	2	510255	9004100539218
40	230	E14	100	35	400	1000	1/10/100	E	2	509595	9004100547213
60	230	E14	100	35	660	1000	1/10/100	E	2	509596	9004100553719

TUNGSRASOFT

opál ● opalizovaná ● opalizovaná ● opal ● mlečna ● млечна ● онал ● opaal ● opāls ● opalinis											
25	230	E14	100	35	200	1000	1/10/50	F	3	33035	5994102330354
40	230	E14	100	35	360	1000	1/10/100	F	3	510249	9004101707012
60	230	E14	100	35	660	1000	1/10/50	E	3	33042	5994102330422

Színes gyertyalámpák
Žárovky svíčkové barevné
Sviečkové farebné žiarovky

Lămpi lumânare colorate
Sveća sijalice u boji
Обоени свеќа сијалици
Цветни лампи-свещ

Värvilised küünallambid
Krāsainās svečveida spuldzes
Spalvotos lemputēs-žvakutēs



piros ● červená ● červená ● roșu ● crvena ● црвена ● червена ● punane ● sarkana ● raudona											
25	230	E14	100	35	–	1000	1/10/100	–	3	510251	9004100523811
sárga ● žlutá ● žltá ● galben ● žuta ● жолта ● жълта ● kollane ● dzeltena ● geltona											
25	230	E14	100	35	–	1000	1/10/100	–	3	510250	9004100524818
zöld ● zelená ● zelená ● verde ● zelena ● зелена ● зелена ● roheline ● žalia ● žalia											
25	230	E14	100	35	–	1000	1/10/100	–	3	510248	9004100527017
kék ● modrá ● modrá ● albastru ● plava ● плава ● синя ● sinine ● zila ● mėlyna											
25	230	E14	100	35	–	1000	1/10/100	–	3	510247	9004100526119

Csavart gyertyalámpák

Žárovky svíčkové s točenou baňkou

Sviečkové žiarovky s točenou bankou

Lámpa lumânare torsadate

Spiralne sveća sijalice

Ребрасти свеќа сијалици

Спирални лампи-свещ

Keeruga küünallambid

Vitas svečveida spuldzes

Susuktos lempuētēs-žvakutēs

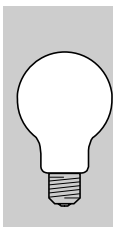
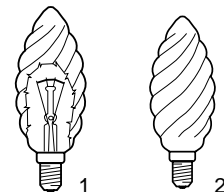

W	V		L _{max.}	∅	lm	t _(h)		EEC	Fig.	SKU	EAN
---	---	--	-------------------	---	----	------------------	--	-----	------	-----	-----

vilāgos ● čirā ● čira ● clar ● bistra ● просирна ● прозрачна ● klaar ● caurspidīga ● skaidrus

25	230	E14	100	35	200	1000	1/10/100	F	1	509598	9004100573618
	240	E14	100	35	200	1000	1/10/100	F	1	507949	9004100574318
40	230	E14	100	35	400	1000	1/10/100	E	1	509599	9004100576411
	240	E14	100	35	400	1000	1/10/100	E	1	507953	9004100577210
60	230	E14	100	35	660	1000	1/10/100	E	1	509605	9004100578910

belūlhomālyositōt ● matovaná ● matovaná ● mat ● matirana ● матирана ● матова ● matt ● matēta ● matinis

25	230	E14	100	35	200	1000	1/10/100	F	2	507948	9004100574813
40	230	E14	100	35	400	1000	1/10/100	E	2	509600	9004100577715
	240	E14	100	35	400	1000	1/10/100	E	2	509601	9004100578712
60	230	E14	100	35	660	1000	1/10/100	E	2	509608	9004100579719

TUNGSRAGLOBE lámpák

Žárovky TUNGSRAGLOBE

Žiarovky TUNGSRAGLOBE

Lámpa TUNGSRAGLOBE

TUNGSRAGLOBE sijalice

TUNGSRAGLOBE сијалици

TUNGSRAGLOBE лампы

TUNGSRAGLOBE lambid

TUNGSRAGLOBE spuldzes

Lempuētēs TUNGSRAGLOBE

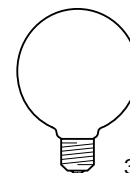

∅ 80 mm

opāl ● opalizovaná ● opalizovaná ● opal ● mlečna ● млечна ● опал ● opaal ● opāls ● opalinis

40	230	E27	119	80	290	2500	1/20	G	3	510244	9004101807712
60	230	E27	119	80	490	2500	1/20	G	3	509611	9004101808917
100	230	E27	119	80	890	2500	1/20	G	3	509612	9004101810514

∅ 95 mm

opāl ● opalizovaná ● opalizovaná ● opal ● mlečna ● млечна ● опал ● opaal ● opāls ● opalinis

40	230	E27	138	95	290	2500	1/20	G	3	510245	9004101822517
60	230	E27	138	95	490	2500	1/20	G	3	509613	9004101823712
100	230	E27	138	95	890	2500	1/20	G	3	509614	9004101824917

∅ 125 mm

opāl ● opalizovaná ● opalizovaná ● opal ● mlečna ● млечна ● опал ● opaal ● opāls ● opalinis

40	230	E27	170	125	290	2500	1/20	G	3	510246	9004101836712
60	230	E27	170	125	490	2500	1/20	G	3	509615	9004101837917
100	230	E27	170	125	890	2500	1/20	G	3	509616	9004101839119
150	230	E27	170	125	1360	2500	1/20	G	3	509617	9004101839911

TUNGSRAFLEX reflektorlámpák
Reflektorové žárovky TUNGSRAFLEX
Reflektorové žiarovky TUNGSRAFLEX

Lámpa reflector TUNGSRAFLEX
TUNGSRAFLEX reflektorske sijalice
TUNGSRAFLEX рефлекторски сијалици
TUNGSRAFLEX рефлектни лампи

TUNGSRAFLEX reflektorlambid
TUNGSRAFLEX reflektorspuldzes
Reflektorinés lempütés TUNGSRAFLEX

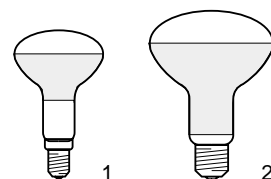

W	V		L _{max.}	Ø	Cd		t _(h)		Fig.	SKU	EAN
R39 (ø 39 mm)											
25	230	E14	66	39	65	80	1000	1/10/100	1	510348	9004101476413
30	230	E14	66	39	80	80	1000	1/10/100	1	509688	9004100412818
R50 (ø 50 mm)											
25	230	E14	86	50	130	35	1000	1/10/100	1	509689	9004100412917
	240	E14	86	50	130	35	1000	1/10/100	1	510350	9004100667614
40	230	E14	86	50	250	35	1000	1/10/100	1	509690	9004100669113
	240	E14	86	50	250	35	1000	1/10/100	1	510349	9004101478912
60	230	E14	86	50	550	35	1000	1/10/100	1	510351	5994100079958
R63 (ø 63 mm)											
40	230	E27	103	63	350	35	1000	1/50	2	509691	9004100378114
	240	E27	103	63	350	35	1000	1/10/50	2	510354	9004100379012
60	230	E27	103	63	550	35	1000	1/50	2	509692	9004100380414
	240	E27	103	63	550	35	1000	1/10/50	2	510353	9004100381411
R80 (ø 80 mm)											
40	230	E27	115	80	140	80	1000	1/25	2	509693	9004100383019
	240	E27	115	80	140	80	1000	1/25	2	510357	9004100384016
60	230	E27	115	80	240	80	1000	1/25	2	509694	9004100385914
	240	E27	115	80	240	80	1000	1/25	2	510356	9004100387215
75	230	E27	115	80	320	80	1000	1/25	2	509695	9004100388410
100	230	E27	115	80	450	80	1000	1/25	2	509696	9004100390918
	240	E27	115	80	450	80	1000	1/25	2	510355	9004100392011
R95 (ø 95 mm)											
75	230	E27	131	95	1000	35	1000	1/15	2	509697	9004100396118
100	230	E27	131	95	1350	35	1000	1/15	2	509698	9004100397412
150	230	E27	131	95	2000	35	1000	1/15	2	510358	9004101905418

ENRICH reflektorlámpák
Reflektorové žárovky ENRICH
Reflektorové žiarovky ENRICH

Lámpa reflector ENRICH
ENRICH reflektorske sijalice
ENRICH рефлекторски сијалици
ENRICH рефлектни лампи

ENRICH reflektorlambid
ENRICH reflektorspuldzes
Reflektorinés lempütés ENRICH

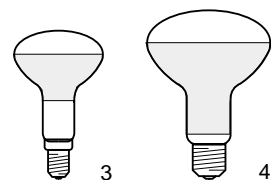

R50 (ø 50 mm)											
25	230	E14	86	50	–	–	1000	1/25	3	91392	5994102333126
40	230	E14	86	50	–	–	1000	1/25	3	91393	5994102333201
R63 (ø 63 mm)											
40	230	E27	103	63	–	–	1000	1/25	4	91339	5994102333256
60	230	E27	103	63	–	–	1000	1/25	4	91340	5994102333355
R80 (ø 80 mm)											
60	230	E27	115	80	–	–	1000	1/20	4	91344	5994102290337
100	230	E27	115	80	–	–	1000	1/20	4	91345	5994102290368
R95 (ø 95 mm)											
75	230	E27	131	95	–	–	1000	1/20	4	91529	0043168328883
100	230	E27	131	95	–	–	1000	1/20	4	92140	0043168328876

DISCOLUX Lamps
Žárovky DISCOLUX
Žiarovky DISCOLUX

Lāmpī DISCOLUX
DISCOLUX sijalice
DISCOLUX сијалици
DISCOLUX лампи

DISCOLUX lambid
DISCOLUX spuldzes
DISCOLUX lempütés

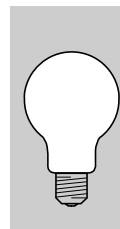
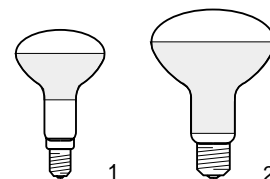

W	V		L _{max.}	Ø	Cd		t _(h)		Fig.	SKU	EAN
---	---	--	-------------------	---	----	--	------------------	--	------	-----	-----

R50 (ø 50 mm)

piros ● červená ● červená ● rožu ● crvena ● црвена ● червена ● punane ● sarkana ● raudona

25	230	E14	86	50	–	–	1000	1/25	1	35601	9004102356011
40	230	E14	86	50	–	–	1000	1/25	1	35605	9004102356059

sárga ● žlutá ● žltá ● galben ● žuta ● жолта ● жълта ● kollane ● dzeltena ● geltona

25	230	E14	86	50	–	–	1000	1/25	1	35602	9004102356028
40	230	E14	86	50	–	–	1000	1/25	1	35612	9004102356127

zöld ● zelená ● zelená ● verde ● zelena ● зелена ● зелена ● roheline ● zala ● žalia

25	230	E14	86	50	–	–	1000	1/25	1	35603	9004102356035
40	230	E14	86	50	–	–	1000	1/25	1	35614	9004102356141

kék ● modrá ● modrá ● albastru ● plava ● плава ● синя ● sinine ● zila ● mėlyna

25	230	E14	86	50	–	–	1000	1/25	1	35604	9004102356042
40	230	E14	86	50	–	–	1000	1/25	1	35611	9004102356110

R63 (ø 63 mm)

piros ● červená ● červená ● rožu ● crvena ● црвена ● червена ● punane ● sarkana ● raudona

40	230	E27	103	63	–	–	1000	1/10/50	2	510402	9004101900512
----	-----	-----	-----	----	---	---	------	---------	---	--------	---------------

sárga ● žlutá ● žltá ● galben ● žuta ● жолта ● жълта ● kollane ● dzeltena ● geltona

40	230	E27	103	63	–	–	1000	1/10/50	2	510417	9004101902110
----	-----	-----	-----	----	---	---	------	---------	---	--------	---------------

zöld ● zelená ● zelená ● verde ● zelena ● зелена ● зелена ● roheline ● zala ● žalia

40	230	E27	103	63	–	–	1000	1/10/50	2	510403	9004101902219
----	-----	-----	-----	----	---	---	------	---------	---	--------	---------------

kék ● modrá ● modrá ● albastru ● plava ● плава ● синя ● sinine ● zila ● mėlyna

40	230	E27	103	63	–	–	1000	1/10/50	2	510404	9004101901618
----	-----	-----	-----	----	---	---	------	---------	---	--------	---------------

R80 (ø 80 mm)

piros ● červená ● červená ● rožu ● crvena ● црвена ● червена ● punane ● sarkana ● raudona

40	230	E27	114	80	–	–	1000	1/25	2	510412	9004100433912
60	230	E27	114	80	–	–	1000	1/25	2	510413	9004101900918
40	240	E27	114	80	–	–	1000	1/25	2	510409	9004101942116

sárga ● žlutá ● žltá ● galben ● žuta ● жолта ● жълта ● kollane ● dzeltena ● geltona

40	230	E27	114	80	–	–	1000	1/25	2	510411	9004100434315
60	230	E27	114	80	–	–	1000	1/25	2	510414	9004101901212
40	240	E27	114	80	–	–	1000	1/25	2	510408	9004101942215

zöld ● zelená ● zelená ● verde ● zelena ● зелена ● зелена ● roheline ● zala ● žalia

40	230	E27	114	80	–	–	1000	1/25	2	510418	9004100435411
60	230	E27	114	80	–	–	1000	1/25	2	510416	9004101901717

kék ● modrá ● modrá ● albastru ● plava ● плава ● синя ● sinine ● zila ● mėlyna

40	230	E27	114	80	–	–	1000	1/25	2	510410	9004100435015
60	230	E27	114	80	–	–	1000	1/25	2	510415	9004101901410
40	240	E27	114	80	–	–	1000	1/25	2	510407	9004101942314



TUNGSRAPAR 38-ES reflektorlámipák
Reflektorové žárovky TUNGSRAPAR 38-ES
Reflektorové žiarovky TUNGSRAPAR 38-ES

Lāmpi reflector TUNGSRAPAR 38-ES
TUNGSRAPAR 38-ES reflektorske sijalice
TUNGSRAPAR 38-ES рефлeкторски сијалици
TUNGSRAPAR 38-ES рефлeктни лампи

TUNGSRAPAR 38-ES reflektorlambid
TUNGSRAPAR 38-ES reflektorspuldzes
Reflektorinēs lempuētēs TUNGSRAPAR 38-ES

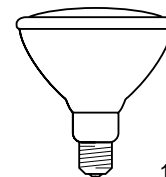

1

W	V		L _{max.}	∅	Cd		t _(h)		Fig.	SKU	EAN
---	---	--	-------------------	---	----	--	------------------	--	------	-----	-----

SPOT

vilāgos ● čirā ● čira ● clar ● bistra ● просирна ● прозрачна ● klaar ● caurspidīga ● skaidrus

60	230	E27	136	122	3400	12	2000	1/12	1	91572	5994102288761
80	230	E27	136	122	5400	12	2000	1/10	1	510363	9004100682617
120	230	E27	136	122	7000	12	2000	1/10	1	510360	9004100689319

FLOOD

vilāgos ● čirā ● čira ● clar ● bistra ● просирна ● прозрачна ● klaar ● caurspidīga ● skaidrus

60	230	E27	136	122	1200	30	2000	1/12	1	91575	5994102288860
80	230	E27	136	122	2000	30	2000	1/10	1	510361	9004100684116
120	230	E27	136	122	3000	30	2000	1/10	1	510359	9004100690513

piros ● červenā ● červenā ● rošu ● crvena ● црвена ● червена ● punane ● sarkana ● raudona

80	230	E27	136	122	–	30	2000	1/10	1	510376	9004100686615
----	-----	-----	-----	-----	---	----	------	------	---	--------	---------------

sārga ● žluta ● žltā ● galben ● žuta ● жолта ● жълта ● kollane ● dzeltena ● geltona

80	230	E27	136	122	–	30	2000	1/10	1	510375	9004100687414
----	-----	-----	-----	-----	---	----	------	------	---	--------	---------------

zöld ● zelenā ● zelenā ● verde ● zelena ● зелена ● зелена ● roheline ● zala ● žalia

80	230	E27	136	122	–	30	2000	1/10	1	510369	9004100688015
----	-----	-----	-----	-----	---	----	------	------	---	--------	---------------

kék ● modrá ● modrá ● albastru ● plava ● плава ● синя ● sinine ● zila ● mėlyna

80	230	E27	136	122	–	30	2000	1/10	1	510362	9004100688718
----	-----	-----	-----	-----	---	----	------	------	---	--------	---------------

Infralámipák
Infražárovky
Infražiarovky

Lāmpi IR
Infracrvene sijalice
Инфрацрвени сијалици
Инфрацрвени лампи

Infrapunalambid
Infrasarkanās spuldzes
Инфрарудонūjū spinduliū lempuētēs

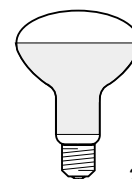

2

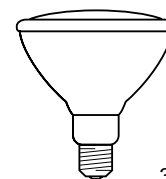

3

INFRASEC

vilāgos ● čirā ● čira ● clar ● bistra ● просирна ● прозрачна ● klaar ● caurspidīga ● skaidrus

150	235/245	E27	180	125	–	–	6000	1/10	2	509699	9004100425412
250	235/245	E27	180	125	–	–	6000	1/10	2	509702	9004100427515

INFRASATIN

szatinírozott ● satinovaná ● satinovaná ● satinat ● satenizirana ● сатенизирана ● сатинирана ● matt ● matēta ● matinis

150	235/245	E27	180	125	–	–	6000	1/10	2	509700	9004100425818
250	235/245	E27	180	125	–	–	6000	1/10	2	509714	9004100428314

INFRARUBIN

rubinszínű ● rubinová ● rubinovaná ● rubiniu ● rubinska ● рубинска ● рубинова ● rubiinpunase ● rubinkrāsas ● rubino

150	235/245	E27	180	125	–	–	6000	1/10	2	509701	9004100426716
250	235/245	E27	180	125	–	–	6000	1/10	2	509715	9004100429519

INFRAPAR

rubinszínű ● rubinová ● rubinovaná ● rubiniu ● rubinska ● рубинска ● рубинова ● rubiinpunase ● rubinkrāsas ● rubino

175	240	E27	136	122	–	–	5000	1/10	3	510389	9004100730912
-----	-----	-----	-----	-----	---	---	------	------	---	--------	---------------

Törpelámpák
Žárovky hruškové
Hruškové žiarovky

Lāmpi miniaturā
Patuljaste sijalice
Џуџести сијалици
Лампи-миньонки

Pisilambid
Miniatūrās spuldzes
Miniatiūrīnēs lemputēs

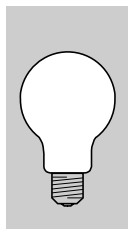
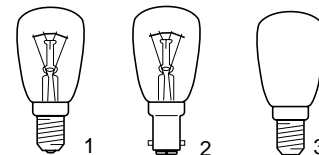

W	V		L _{max.}	∅	lm	t _(h)		EEC	Fig.	SKU	EAN
---	---	--	-------------------	---	----	------------------	--	-----	------	-----	-----

vilāgos	čirā	čira	clar	bistra	просирна	прозрачна	klaar	caurspidīga	skaidrus			
5	230	E14	60	26	40	1000	1/100	C	1	148812	9004100488110	
12	230	E14	60	26	60	1000	1/100	F	1	509704	9004100489117	
15	24	E14	60	26	90	1000	1/100	F	1	509708	9004100605913	
	230	E14	60	26	90	1000	1/100	F	1	509705	9004100490618	
	230	E14	65	28	90	1000	1/100	F	1	509602	9004101611210	
	240	E14	60	26	90	1000	1/100	F	1	509706	9004100492414	
	240	E14	65	28	90	1000	1/10/100	F	1	511607	9004100507712	
25	230	E14	65	28	190	1000	1/100	F	1	509709	9004101611319	
	240	E14	65	28	190	1000	1/10/100	F	1	510500	9004100511610	
15	230	B15d	59	26	90	1000	1/100	F	2	509707	9004100495811	
	240	B15d	59	26	90	1000	1/10/100	F	2	510495	9004100496016	

beilūhomālyositott	matovaná	matovaná	mat	matirana	матирана	матова	matt	matēta	matinis			
15	230	E14	60	26	90	1000	1/10/100	F	3	510498	9004100493916	
	240	E14	60	26	90	1000	1/10/100	F	3	510496	9004100494814	
25	230	E14	65	28	190	1000	1/10/100	F	3	510499	9004100512617	
	240	E14	65	28	190	1000	1/10/100	F	3	510497	9004100513416	

Kályhalámpák ● **Žárovky pro pečicí trouby** ● **Žiarovky do pečiacich rúr**
Lāmpi pentru cuptor ● **Sijalice za rerne** ● **Сијалици за релна** ● **Лампи за фурни**
Ahju lambid ● **Spuldzes cepeškrāsnīm** ● **Orkaičiļ lemputēs**



vilāgos	čirā	čira	clar	bistra	просирна	прозрачна	klaar	caurspidīga	skaidrus			
15	230	E14	49	22	63	1000	1/50	G	4	92049	5994102332297	
25	230	E14	65	28	142	1000	1/50	G	4	36882	0043168368827	

Csőburás lámpák
Žárovky trubkové
Trubkové žiarovky

Lāmpi tubulare
Signalne sijalice
Сигнални сијалици
Лампи с тръбна колба

Torukujulise kolviga lambid
Cilindriskas spuldzes
Vamzdinēs lemputēs

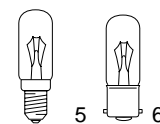

vilāgos	čirā	čira	clar	bistra	просирна	прозрачна	klaar	caurspidīga	skaidrus			
25	230/240	E14	–	28	200	1000	1/50	F	5	92064	0043168299862	
40	230/240	E14	–	28	400	1000	1/50	E	5	92065	0043168298964	
60	230/240	E14	–	28	600	1000	1/50	F	5	92066	0043168299565	
25	230/240	B22	–	28	200	1000	1/50	F	6	92067	0043168299886	
40	230/240	B22	–	28	400	1000	1/50	E	6	92068	0043168298858	
60	230/240	B22	–	28	600	1000	1/50	F	6	92069	0043168299855	

Vagonlámpák

Žárovky do železničních vagónů

Žiarovky do železničných vagónov

Lămpi pentru vagoane

Vagonske sijalice

Вагонски сијалици

Лампи за вагони

Rongi lambid

Spuldzes vilcieniem

Traukinių lemputės

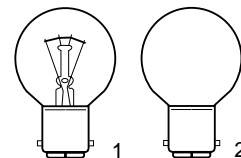
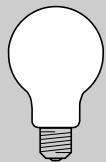

W	V		L _{max.}	∅	lm	t _(h)		EEC	Fig.	SKU	EAN
világos ● čirá ● číra ● clar ● bistra ● просирна ● прозрачна ● klaar ● caurspīdīga ● skaidrus											
15	26	B22	70	45	130	1000	1/10/100	D	1	161123	9004100611211
25	78	B22	70	45	230	1000	1/10/100	E	1	161322	9004100613215
30	26	B22	70	45	350	1000	1/10/100	D	1	161432	9004100614311
40	78	B22	70	45	420	1000	1/10/100	E	1	161494	9004100614915
opál ● opalizovaná ● opalizovaná ● opal ● mlečna ● млечна ● опал ● opaal ● opāls ● opalinis											
20	28	B22	70	45	165	1000	1/10/100	E	2	161232	9004100612317

Éjszakai lámpák

Žárovky NIGHT

Žiarovky NIGHT

Lămpi de veghe

Sijalice za noćne lampe

Нoќни сијалици

Нoщни лампи

Öö lambid

Nakts spuldzes

Naktinēs lemputės

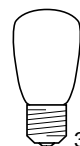

belūhromályosított ● matovaná ● matovaná ● mat ● matirana ● матирана ● матова ● matt ● matēta ● matinis											
-	230	E27	74	45	-	1000	1/10/100	-	3	510274	9004100462110
opál ● opalizovaná ● opalizovaná ● opal ● mlečna ● млечна ● опал ● opaal ● opāls ● opalinis											
-	230	E27	74	45	-	1000	1/10/100	-	3	510273	9004100463018
piros ● červená ● červená ● rošu ● crvena ● црвена ● червена ● punane ● sarkana ● raudona											
-	230	E27	74	45	-	1000	1/10/100	-	3	510283	9004100463315
sárga ● žlutá ● žltá ● galben ● žuta ● жолта ● жълта ● kollane ● dzeltena ● geltona											
-	230	E27	74	45	-	1000	1/10/100	-	3	510282	9004100463810
zöld ● zelená ● zelená ● verde ● zelena ● зелена ● зелена ● roheline ● žala ● žalia											
-	230	E27	74	45	-	1000	1/10/100	-	3	510280	9004100464817
kék ● modrá ● modrá ● albastru ● plava ● плава ● синя ● sinine ● zila ● mėlyna											
-	230	E27	74	45	-	1000	1/10/100	-	3	510281	9004100464411

Karácsonyfa-lámpák
Žárovky CHRISTMAS-TREE
Žiarovky CHRISTMAS-TREE (vianočné)

Lămpi pentru pomul de Crăciun
 Sijalice za novogodišnju jelku
 Сијалици за коледно дрво
 Лампи за коледно дърво

Jõulupuu lambid
 Ziemassvētku spuldzes
 Kalēdinēs lemputēs

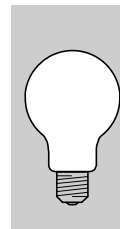
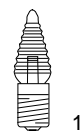

W	V		L _{max.}	∅	lm	t _(h)		EEC	Fig.	SKU	EAN
világos ● čirá ● číra ● clar ● bistra ● просирна ● прозрачна ● klaar ● caurspidīga ● skaidrus											
3 (8019)	14	E10	45	15,5	–	500	1/10	–	1	231000	–
piros ● červená ● červená ● rožu ● crvena ● црвена ● червена ● punane ● sarkana ● raudona											
3 (8019)	14	E10	45	15,5	–	500	1/10	–	1	231010	–
sárga ● žlutá ● žltá ● galben ● žuta ● жолта ● жълта ● kollane ● dzeltena ● geltona											
3 (8019)	14	E10	45	15,5	–	500	1/10	–	1	231040	–
zöld ● zelená ● zelená ● verde ● zelena ● зелена ● зелена ● roheline ● zala ● žalia											
3 (8019)	14	E10	45	15,5	–	500	1/10	–	1	231020	–
kék ● modrá ● modrá ● albastru ● plava ● плава ● синя ● sinine ● zila ● mėlyna											
3 (8019)	14	E10	45	15,5	–	500	1/10	–	1	231030	–



TUNGSRALIN vonalizzók
Žárovky lineární TUNGSRALIN
Lineárne žiarovky TUNGSRALIN

Lămpi incandescente lineare TUNGSRALIN
 TUNGSRALIN lineare cevaste sijalice
 TUNGSRALIN линейарни цевкасти сијалици
 TUNGSRALIN линейно-тръбни лампи

TUNGSRALIN torulambid
 TUNGSRALIN lineārās spuldzes
 Vamzdinēs lemputēs TUNGSRALIN

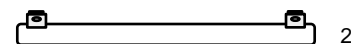

opál ● opalizovaná ● opalizovaná ● opal ● mlečna ● млечна ● опал ● opaal ● opáls ● opalinis											
60	230	2xS14s	300	30	420	1500	1/25	G	2	509712	9004101511411
100	230	2xS14s	500	30	720	1500	1/25	G	2	509710	9004101507315
35	230	2xS14s	300	30	220	2500	1/25	G	2	509711	9004101508619
60	230	2xS14s	500	30	420	2500	1/25	G	2	509713	9004101511619



Nyomógombos lámpatestek ● Svítidlo s vypínačem ● Sviétidlo s vypínačom

Corp de iluminat cu buton ● Svjetilka sa prekidačem ● Светилки со копче ● Осветители с бутон за вклучване и изклучване
 Standartinēs lemputēs ● Gaismeklis ar slēdzi ● Šviestuvas su mygtuku

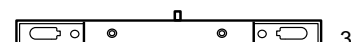

TLBD300D – 300 mm x 25 mm x 30 mm											
fehér ● bílá ● biela ● alb ● bela ● бела ● бяла ● valge ● balta ● balta											
35/60	–	–	–	–	–	1/20	–	–	3	404054	9004100902906
TLBD500D – 500 mm x 25 mm x 30 mm											
fehér ● bílá ● biela ● alb ● bela ● бела ● бяла ● valge ● balta ● balta											
60/100	–	–	–	–	–	1/20	–	–	3	404056	9004100902920



Dekorációs lámpák
Žárovky dekorativní
Dekoratívne žiarovky

Lămpi decorative
Dekoratívne sijalice
Декоративни сијалици
Лампи декоративни

Dekoriativlambid
Dekoratívás spulzdes
Dekoratyvinės lemputės

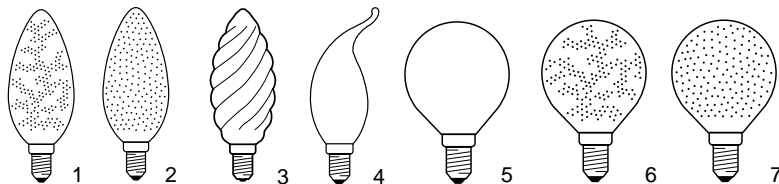
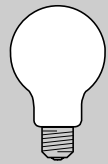

Type	W	V		L _{max.}	∅	lm	t _(h)		EEC	Fig.	SKU	EAN
------	---	---	--	-------------------	---	----	------------------	--	-----	------	-----	-----

Gyertyalámpák ● **Žárovky svičkové** ● **Sviečkové žiarovky** ● **Lămpi lumânare** ● **Sveća sijalice** ● **Свеќа сијалици**
Лампи-свеч ● **Küünallambid** ● **Svečveida spulzdes** ● **Lemputės-žvakutės**



aranyszínű krokodilbőr-utánzat ● imitace krokodýlové kůže - zlatá ● imitácia krokodílovej kože - zlatá ● "piele de crocodil" auriu
Kroko-zlatna ● Kroko-златен ● **златна крокодилска кожа** ● Kroko-Gold (kuldne krokodillinahk) ● Kroko-Gold ("zelita krokodiláda")
 Kroko-Gold (auksinė krokodilo oda)

25C1/KrokoGD/E14	25	230	E14	100	35	150	1000	1/10/50	G	1	91739	0043168364263
40C1/KrokoGD/E14	40	230	E14	100	35	320	1000	1/10/50	F	1	90494	0043168328678

opál jégkristály ● opalizovaný ledový kryštál ● opalizovaný ľadový kryštál ● cristal de gheață opal ● mlečna kristali leda
 кристали од мраз - млечна ● **леден кристал опал** ● opaal jääkristall ● **ledus kristāls, opāls** ● ledo skaidrumo opals

25C1/IceCR-WH/E14	25	230	E14	100	35	160	1000	1/10/50	G	2	91735	0043168364232
40C1/IceCR-WH/E14	40	230	E14	100	35	350	1000	1/10/50	F	2	90493	0043168328692

borostyánsárga jégkristály ● žlutý ledový kryštál ● žltý ľadový kryštál ● cristal de gheață ambră ● **amber kristali leda** ● кристали од мраз
 - темно жолта ● **леден кристал кехлибар** ● merevaigu jääkristall ● **ledus kristāls, dzintars** ● ledo skaidrumo gintaras

25C1/IceCR-AM/E14	25	230	E14	100	35	150	1000	1/10/50	G	2	91733	0043168364249
40C1/IceCR-AM/E14	40	230	E14	100	35	320	1000	1/10/50	F	2	90492	0043168328708

aranyszínű csavart gyertyalámpa ● točená baňka - zlatá ● **točená banka - zlatá** ● lumânare torsadă auriu ● **spiralna zlatna**
 ребрасти свеќа сијалици - златно-сјајна ● **златна бляскава спирална лампа-свеч** ● kullakarva keeruga küünallambid
spidigi zeltaina vitā svečveida spulzdes ● aukso spindesio susuktos lemputės-žvakutės

25TC1/GDGoss-CL/E14	25	230	E14	100	35	150	1000	1/10/50	G	3	91626	0043168364256
40TC1/GDGoss-CL/E14	40	230	E14	100	35	320	1000	1/10/50	F	3	91324	0043168328722

hajlított végű, belülhomályosított ● matovaná s ohnutým vrchlíkom ● **matovaná s ohnutým vrchlíkom** ● tip flacără, mat ● **mat Bent-tip**
 Bent-tip - матирана ● **наклонен врх, матова** ● tilgakujuline matt ● **Bent-tip (ar izliektu galu, matētas)** ● Bent-tip matinis

25C1/BentTipFR/E14	25	230	E14	-	35	200	1000	1/25	F	4	92672	0043168328739
40C1/BentTipFR/E14	40	230	E14	-	35	400	1000	1/25	E	4	92673	0043168328784

Gömblámpák ● **Žárovky iluminační** ● **Guličkové žiarovky** ● **Lămpi sferice** ● **Okrugle sijalice** ● **Тркалезни сијалици**
Сферични лампи ● **Dekoriativlambid** ● **Sfēriskas spulzdes** ● **Rutulinės lemputės**

aranyszínű ● zlatá ● **zlatá** ● auriu ● **zlatna** ● златна ● **златна** ● kuldne ● **zelta** ● auksas

25WSPH/Lustergold/E14	25	230	E14	79	45	150	1000	1/25	G	5	92090	0043168364683
40WSPH/Lustergold/E14	40	230	E14	79	45	320	1000	1/25	F	5	92091	0043168364706
25WSPH/CMRgold/E14	25	230	E14	79	45	130	1000	1/25	G	5	91918	0043168364614

aranyszínű krokodilbőr-utánzat ● imitace krokodýlové kůže - zlatá ● imitácia krokodílovej kože - zlatá ● "piele de crocodil" auriu
Kroko-zlatna ● Kroko-златен ● **златна крокодилска кожа** ● Kroko-Gold (kuldne krokodillinahk) ● Kroko-Gold ("zelita krokodiláda")
 Kroko-Gold (auksinė krokodilo oda)

25WSPH/KRO-Gold/E14	25	230	E14	79	45	150	1000	1/25	G	6	91920	0043168364621
40D1/KrokoGD/E14	40	230	E14	79	45	320	1000	1/25	F	6	90559	0043168328791

opál jégkristály ● opalizovaný ledový kryštál ● opalizovaný ľadový kryštál ● cristal de gheață opal ● mlečna kristali leda
 кристали од мраз - млечна ● **леден кристал опал** ● opaal jääkristall ● **ledus kristāls, opāls** ● ledo skaidrumo opals

25WSPH/Ice-WH/E14	25	230	E14	79	45	160	1000	1/25	G	7	91615	0043168364669
40D1/IceCR-WH/E14	40	230	E14	79	45	350	1000	1/25	F	7	91921	0043168328814

borostyánsárga jégkristály ● žlutý ledový kryštál ● žltý ľadový kryštál ● cristal de gheață ambră ● **amber kristali leda** ● кристали од мраз
 - темно жолта ● **леден кристал кехлибар** ● merevaigu jääkristall ● **ledus kristāls, dzintars** ● ledo skaidrumo gintaras

25WSPH/Ice-WAM/E14	25	230	E14	79	45	150	1000	1/25	G	7	91919	0043168364676
40D1/IceCR-AM/E14	40	230	E14	79	45	320	1000	1/25	F	7	90558	0043168328838

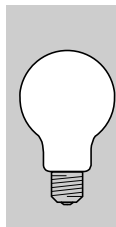
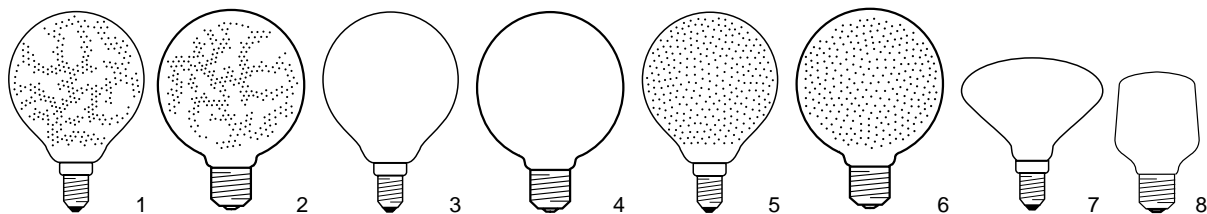

Type	W	V		L _{max.}	∅	lm	t _(h)		EEC	Fig.	SKU	EAN
------	---	---	--	-------------------	---	----	------------------	--	-----	------	-----	-----

GLOBE lámpák ● Žárovky GLOBE ● Žiarovky GLOBE ● Lāmpi GLOBE ● GLOBE sijalice ● GLOBE сijaлицы
GLOBE лампи ● GLOBE lambid ● GLOBE spuldzes ● Lemputės GLOBE



aranyszínű krokodilbőr-utánzat ● imitace krokodýlové kůže - zlatá ● imitácia krokodilovej kože - zlatá ● "piele de crocodil" auriu
 Kroko-zlatna ● Kroko-златен ● златна крокодилска кожа ● Kroko-Gold (kuldne krokodillinahk) ● Kroko-Gold ("zelita krokodilāda")

Kroko-Gold (auksinē krokodilo oda)

25G60/KrokoGD/E14	25	230	E14	-	60	140	1000	1/25	G	1	91252	0043168364447
40G60/KrokoGD/E14	40	230	E14	-	60	260	1000	1/25	G	1	91098	0043168327725
60G60/KrokoGD/E14	60	230	E14	-	60	450	1000	1/25	G	1	91262	0043168364461
40G60/KrokoGD/E27	40	230	E27	-	60	260	1000	1/25	G	2	91241	0043168327749
60G60/KrokoGD/E27	60	230	E27	-	60	450	1000	1/25	G	2	91254	0043168364546
40G80/KrokoGD/E27	40	230	E27	119	80	260	1000	1/20	G	2	91256	0043168327794
40G95/KrokoGold/E27	40	230	E27	138	95	260	1000	1/20	G	2	91463	0043168327817
60G95/KrokoGold/E27	60	230	E27	138	95	450	1000	1/20	G	2	91111	0043168327824
100G95/KrokoGold/E27	100	230	E27	138	95	830	1000	1/20	G	2	91114	0043168364607

aranyszínű ● zlatá ● zlatá ● auriu ● zlatna ● златна ● златна ● kuldne ● zelta ● auksas

25G60/Gold/E14	25	230	E14	-	60	140	1000	1/25	G	3	91251	0043168364522
40G60/Gold/E14	40	230	E14	-	60	260	1000	1/25	G	3	91253	0043168364539
40G60/Gold/E27	40	230	E27	-	60	260	1000	1/25	G	4	91242	0043168364577
60G60/Gold/E27	60	230	E27	-	60	450	1000	1/25	G	4	91243	0043168364584

opál jégkristály ● opalizovaný ledový kryštál ● opalizovaný ľadový kryštál ● cristal de gheață opal ● mlečna kristali leda

кристали од мраз - млечна ● леден кристал опал ● opaal jääkristall ● ledus kristāls, opāls ● ledo skaidrumo opals

40G60/IceCR-WH/E14	40	230	E14	-	60	300	1000	1/25	G	5	91097	0043168327985
40G60/IceCR-WH/E27	40	230	E27	-	60	300	1000	1/25	G	6	91240	0043168328005
40G80/IceCR-WH/E27	40	230	E27	119	80	300	1000	1/20	G	6	91255	0043168328159
60G80/IceCR-WH/E27	60	230	E27	119	80	500	1000	1/20	G	6	91257	0043168328166
40G95/IceCR-WH/E27	40	230	E27	138	95	300	1000	1/20	G	6	91149	0043168328180
60G95/IceCR-WH/E27	60	230	E27	138	95	500	1000	1/20	G	6	91113	0043168328258
100G95/IceCR-WH/E27	100	230	E27	138	95	920	1000	1/20	G	6	91152	0043168328326

borostyánsárga jégkristály ● žltý ledový kryštál ● žltý ľadový kryštál ● cristal de gheață ambră ● amber kristali leda ● кристали од мраз

- темно жолта ● леден кристал кехлибар ● merevaigu jääkristall ● ledus kristāls, dzintars ● ledo skaidrumo gintaras

25G60/IceCR-WH/E14	25	230	E14	-	60	170	1000	1/25	G	5	91249	0043168364508
40G60/IceCR-AM/E14	40	230	E14	-	60	260	1000	1/25	G	5	91096	0043168328074
25G60/IceCR-AM/E14	25	230	E27	-	60	140	1000	1/25	G	6	91250	0043168364515
40G60/IceCR-AM/E27	40	230	E27	-	60	260	1000	1/25	G	6	91239	0043168328142
40G80/IceCR-AM/E27	40	230	E27	119	80	260	1000	1/10	G	6	91148	0043168328357
60G80/IceCR-AM/E27	60	230	E27	119	80	450	1000	1/10	G	6	91103	0043168328418
40G95/IceCR-AM/E27	40	230	E27	138	95	260	1000	1/20	G	6	91110	0043168328449
60G95/IceCR-AM/E27	60	230	E27	138	95	450	1000	1/20	G	6	91112	0043168328456
100G95/IceCR-AM/E27	100	230	E27	138	95	830	1000	1/20	G	6	91151	0043168328470

ELDEA

opál ● opalizovaná ● opalizovaná ● opal ● mlečna ● млечна ● опал ● opaal ● opāls ● opalinis

25ELDEA/O/E14	25	230	E14	-	72	160	1000	1/25	F	7	92604	0043168328951
40ELDEA/O/E14	40	230	E14	-	72	350	1000	1/25	F	7	92605	0043168329064

ELROYAL

opál ● opalizovaná ● opalizovaná ● opal ● mlečna ● млечна ● опал ● opaal ● opāls ● opalinis

40ELROYAL/O/E27	40	230	E27	-	61	360	1000	1/25	F	8	32897	0043168328975
-----------------	----	-----	-----	---	----	-----	------	------	---	---	-------	---------------

Kisfeszültségű halogén reflektorlámpák
Halogenové reflektorové žárovky pro malé napětí
Halogénové reflektorové žiarovky na malé napätia

Lämpit halogene de tensiune redusă
Niskonaponske halogene reflektorske sijalice
Нисконапонски халогени сијалици
Ниско напрежение халогенни лампи

Reflektoriga madalapingehalogenlambid
Zemsprieguma halogēnspuļdes
Žemos įtampos halogeninės reflektorinės lemputės

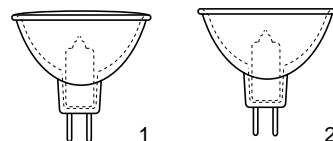

Type	W	V		Cd	CCT		t _(h)		Fig.	SKU	EAN
------	---	---	--	----	-----	--	------------------	--	------	-----	-----

Precise™ MR16 ConstantColor™

ø 50 mm

zárt hidegtűkör ● s uzavřeným studeným zrcadlem ● uzatvorené so studeným zrkadlom ● oglindă dicroic închisă ● zatzvorenno dihiroik ogledalo

zatzvorenno dihiroik ogledalo ● zatzvorenno dihiroichno ogledalo ● suletud dikroidreflektor ● slēgts dihiroisks spogulis ● uždaras dichroinis veidrodis

ESX/CG	20	12	GU5,3	3350	2900	12	5000	1/10	1	20858	0043168992961
BAB/CG	20	12	GU5,3	475	2900	40	5000	1/10	1	20857	0043168992954
FRB/CG	20	12	GU5,3	7500	3000	12	5000	1/10	1	20864	—
FRA/CG	35	12	GU5,3	3200	3000	20	5000	1/10	1	20860	0043168992985
FMW/CG	35	12	GU5,3	900	3000	40	5000	1/10	1	20859	0043168992978
EXT/CG	50	12	GU5,3	8500	3050	14	6000	1/10	1	20872	0043168994224
EXZ/CG	50	12	GU5,3	2800	3050	25	6000	1/10	1	20871	0043168994217
EXN/CG	50	12	GU5,3	1450	3050	40	6000	1/10	1	20867	0043168994194
FNV/CG	50	12	GU5,3	850	3050	55	6000	1/10	1	20865	0043168994187
EYF/CG	71	12	GU5,3	11200	3050	15	4000	1/10	1	20876	0043168994255
EYJ/CG	71	12	GU5,3	4600	3050	25	4000	1/10	1	20874	0043168994248
EYC/CG	71	12	GU5,3	1950	3050	42	4000	1/10	1	20873	0043168994231

Precise™ Bright MR16

ø 50 mm

nyitott hidegtűkör ● s otevřeným studeným zrcadlem ● otvorené so studeným zrkadlom ● oglindă dicroic deschisă ● otvorenno dihiroik ogledalo

otvorenno dihiroik ogledalo ● otvorenno dihiroichno ogledalo ● avatud dikroidreflektor ● valējs dihiroisks spogulis ● atviras dichroinis veidrodis

52330 WFL	BAB	20	12	GU5,3	500	3000	36	4000	1/10	2	509442	5994100094425
52400 WFL	FMW	35	12	GU5,3	1620	3000	36	4000	1/10	2	509440	5994100094401
52290 NFL	EXZ	50	12	GU5,3	5920	3000	18	4000	1/10	2	509443	5994100094432
52360 WFL	EXN	50	12	GU5,3	2600	3000	36	4000	1/10	2	509441	5994100094418

zárt hidegtűkör ● s uzavřeným studeným zrcadlem ● uzatvorené so studeným zrkadlom ● oglindă dicroic închisă ● zatzvorenno dihiroik ogledalo

zatzvorenno dihiroik ogledalo ● zatzvorenno dihiroichno ogledalo ● suletud dikroidreflektor ● slēgts dihiroisks spogulis ● uždaras dichroinis veidrodis

52330 WFL	BAB/CG	20	12	GU5,3	450	3000	36	4000	1/10	1	509439	5994100094395
52400 WFL	FMW/CG	35	12	GU5,3	1300	3000	36	4000	1/10	1	509436	5994100094364
52290 NFL	EXZ/CG	50	12	GU5,3	4750	3000	18	4000	1/10	1	509437	5994100094371
52360 WFL	EXN/CG	50	12	GU5,3	2100	3000	36	4000	1/10	1	509438	5994100094388

MR16 Start

ø 50 mm

nyitott hidegtűkör ● s otevřeným studeným zrcadlem ● otvorené so studeným zrkadlom ● oglindă dicroic deschisă ● otvorenno dihiroik ogledalo

otvorenno dihiroik ogledalo ● otvorenno dihiroichno ogledalo ● avatud dikroidreflektor ● valējs dihiroisks spogulis ● atviras dichroinis veidrodis

SP	ESX	20	12	GU5,3	3500	3000	12	2000	1/20	2	510550	5994100105503
WFL	BAB	20	12	GU5,3	500	2900	36	2000	1/20	2	510269	5994100102694
SP	FRB	35	12	GU5,3	7500	3000	12	2000	1/20	2	510551	5994100105510
WFL	FMW	35	12	GU5,3	925	3000	36	2000	1/20	2	510268	5994100102687
SP	EXT	50	12	GU5,3	9500	3000	12	2000	1/20	2	510552	5994100105527
WFL	EXN	50	12	GU5,3	1500	3000	36	2000	1/20	2	510270	5994100102700

zárt hidegtűkör ● s uzavřeným studeným zrcadlem ● uzatvorené so studeným zrkadlom ● oglindă dicroic închisă ● zatzvorenno dihiroik ogledalo

zatzvorenno dihiroik ogledalo ● zatzvorenno dihiroichno ogledalo ● suletud dikroidreflektor ● slēgts dihiroisks spogulis ● uždaras dichroinis veidrodis

SP	ESX/CG	20	12	GU5,3	3150	2900	12	2000	1/20	1	510553	5994100105534
WFL	BAB/CG	20	12	GU5,3	450	2900	36	2000	1/20	1	510512	5994100105121
SP	FRB/CG	35	12	GU5,3	6750	3000	12	2000	1/20	1	510555	5994100105558
WFL	FMW/CG	35	12	GU5,3	830	3000	36	2000	1/20	1	510511	5994100105114
SP	EXT/CG	50	12	GU5,3	8550	3000	12	2000	1/20	1	510554	5994100105541
WFL	EXN/CG	50	12	GU5,3	1350	3000	36	2000	1/20	1	510513	5994100105138

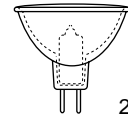
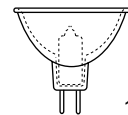
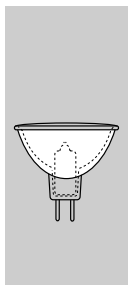
**Type****W****V****Cd****CCT****t_(h)****Fig.****SKU****EAN****Precise™ MR11**

ø 35 mm

nyitott hidegtükör ● s otevřeným studeným zrcadlem ● otvorené so studeným zrkadlom ● oglindă dicroic deschisă ● otvoreno dihroik ogledalo

отворено дихроик огледало ● отворено дихроично огледало ● avatud dikroidreflektor ● valēis dihroisks spogulis ● atviras dichroinis veidrodis

M64/FTA	12	12	GU4	4400	2900	8	2000	1/10	1	30759	0043168307598
M52/FTB	20	12	GU4	4400	2900	10	3500	1/10	1	30755	0043168307550
M51/FTC	20	12	GU4	2000	2900	17	3500	1/10	1	30754	0043168307543
M62/FTD	20	12	GU4	550	2900	26	3500	1/10	1	30773	0043168307734
M65/FTE	35	12	GU4	7000	2900	10	3500	1/10	1	30760	0043168307604
M66/FTF	35	12	GU4	2300	2900	21	3500	1/10	1	30774	0043168307741
M199/FTH	35	12	GU4	1300	2900	26	3500	1/10	1	30890	0043168308900

ø 35 mm

zárt hidegtükör ● s uzavřeným studeným zrcadlem ● uzatvorené so studeným zrkadlom ● oglindă dicroic închisă ● zatvoreno dihroik ogledalo

zatvoreno dikhroik ogledalo ● zatvoreno dikhroichno ogledalo ● suletud dikroidreflektor ● slēgts dihroisks spogulis ● uždaras dichroinis veidrodis

M264/FTA/CG	12	12	GU4	3960	2900	8	2000	1/10	2	30768	0043168307680
M252/FTB/CG	20	12	GU4	3960	2900	10	3500	1/10	2	30763	0043168307635
M251/FTC/CG	20	12	GU4	1800	2900	17	3500	1/10	2	30762	0043168307628
M262/FTD/CG	20	12	GU4	490	2900	26	3500	1/10	2	30775	5021731307751
M265/FTE/CG	35	12	GU4	6300	2900	10	3500	1/10	2	30769	0043168307697
M266/FTF/CG	35	12	GU4	2070	2900	21	3500	1/10	2	30777	5021731307775

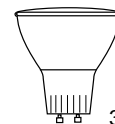
Hálózati feszültségű halogén reflektorlámpák**Halogenové reflektorové žárovky na síťové napětí****Halogenové reflektorové žiarovky na sieťové napätie****Lămpi halogene și funcționare la 230V****Halogene reflektorske sijalice za mrežni napon****Халогени рефлекторски сијалици за мрежен напон****Халогенни лампи за мрежово напрежение****Võrgupingel töötavad reflektoriga halogeenlambid****Pamatsprieguma halogēnspuldzes****Elektros tinklo ītampos halogēnīnēs reflektorīnēs lemputēs****MR16 Mains**

ø 50 mm

zárt tükör ● s uzavřeným zrcadlem ● uzatvorené zrkadlom ● oglindă închisă ● zatvoreno ogledalo

zatvoreno ogledalo ● zatvoreno ogledalo ● suletud reflektor ● slēgts spogulis ● uždaras veidrodis

Q50MR16/230/SP	50	230	GU10	1250	2800	25	2000	1/50	3	91770	0043168917704
Q50MR16/230/FL	50	230	GU10	600	2800	50	2000	1/50	3	91771	0043168917711

MR16 Mains Start

ø 50 mm

zárt tükör ● s uzavřeným zrcadlem ● uzatvorené zrkadlom ● oglindă închisă ● zatvoreno ogledalo

zatvoreno ogledalo ● zatvoreno ogledalo ● suletud reflektor ● slēgts spogulis ● uždaras veidrodis

Q50MR16/230/FL	50	230	GU10	600	2700	36	1500	1/10	3	92729	0043168927291
-----------------------	----	-----	------	-----	------	----	------	------	---	-------	---------------

Egy végén fejelt, kieszűltégű halogénlámpák
Jednopicové halogenové žárovky pro malé napětí
Jednostranne päticované halogénové žiarovky na malé napätia

Lămpi halogene de tensiune redusă cu racord la un capăt
Niskonaponske halogene sijalice sa jednim podnožjom

Нисконапонски едностранни халогени сијалици
Ниско напрежение халогенни лампи с едностранен цокъл

Ūhe sokliga madalapingehalogenlambid
Zemsprieguma vienkontakta halogēnspludzes
Žemos įtampos halogeninės lemputės su viename gale esančiais išvadais

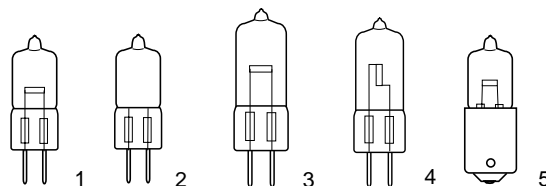

Type	W	V		L _{max.}	∅	LCL	Im	t _(h)		Fig.	SKU	EAN
------	---	---	--	-------------------	---	-----	----	------------------	--	------	-----	-----

UV-Control üvegburában
v baňce UV-Control
v banke UV-Control

în balon de sticlă UV-Control
u UV-Control staklenom balonu
во UV-Control стаклен балон
в UV-Control стъклен балон

UV-kiirgust neelava klaaskolviiga
ar UV starojuma kontroli kapsulā
ir UV spindulių nepraleidžiančiu stikliniu korpusu

világos ● čirá ● číra ● clar ● bistra ● просирна ● прозрачна ● klaar ● caurspidīga ● skaidrus												
56040	20	12	G4	332	9	19,5 ±0.25	380	2000	1/20	1	509452	5994100094524
									250 bulk	1	213606	-

belülhomályosított ● matovaná ● matovaná ● mat ● matirana ● матирана ● матова ● matt ● matēta ● matinis												
56040	20	12	G4	33	9	19,5 ±0.25	380	2000	1/20	2	510642	5994100106425

világos ● čirá ● číra ● clar ● bistra ● просирна ● прозрачна ● klaar ● caurspidīga ● skaidrus												
56530	20	12	GY6,35-15	44	11	30,0 ±0.25	350	2000	1/20	3	509446	5994100094463
56540	35	12	GY6,35-15	44	11	30,0 ±0.25	600	2000	1/20	3	509447	5994100094470
56500	50	12	GY6,35-15	44	11	30,0 ±0.25	900	2000	1/20	3	509444	5994100094449
56550	50	24	GY6,35-15	44	11	30,0 ±0.25	750	2000	1/20	3	510643	5994100106432
56510	100	12	GY6,35-15	44	11	30,0 ±0.25	2350	2000	1/20	3	509445	5994100094456

M76/Q20/GY6.35	20	12	GY6,35-15	44	11	30,0 ±0.25	300	3000	1/20	4	34712	9004102347125
M116/Q35/GY6.35	35	6	GY6,35-15	44	11	30,0 ±0.25	600	2000	1/20	4	34711	9004102347118
M75/Q35/GY6.35	35	12	GY6,35-15	44	11	30,0 ±0.25	600	3000	1/20	4	34710	9004102347101
M74/Q50/GY6.35	50	12	GY6,35-15	44	11	30,0 ±0.25	900	3000	1/20	4	34703	9004102347033
M73/Q75/GY6.35	75	12	GY6,35-15	44	11	30,0 ±0.25	1350	3000	1/20	4	34683	9004102346838
M180	100	12	GY6,35-15	44	11	30,0 ±0.25	2150	3000	1/20	4	34664	9004102346647

56050	6	6	G4	33	9	19,50 ±0.25	100	100	1/20	1	510639	5994100106395
56010	10	6	G4	33	9	19,50 ±0.25	200	100	1/20	1	509502	5994100095026
56020	20	6	G4	33	9	19,50 ±0.25	450	100	1/20	1	509503	5994100095033
56030	20	12	G4	33	9	19,50 ±0.25	550	100	1/20	1	510641	5994100106418
56120	20	6	BA9s	31	9	15,0 ±1.5	400	100	1/20	5	510640	5994100106401
56110	20	12	BA9s	31	9	15,0 ±1.5	500	100	1/20	5	509504	5994100095040

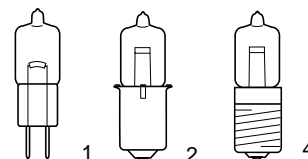
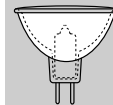

Type	W	V		L _{max.}	Ø	LCL	lm	t _(h)		Fig.	SKU	EAN
------	---	---	--	-------------------	---	-----	----	------------------	--	------	-----	-----

keményűvegűvegburában
s baňkou z tvrdého skla
s bankou z tvrdého skla

în balon de sticlă dură
u balonu od tvrdog stakla
во балон од тврдо стакло
в балонот твърдо стъкло

kõva klaaskolviga
cietā stikla kapsulā
ir korpusu iš sunkiai lydomo stiklo



világos	čirá	čira	clar	bistra	просирна	прозрачна	klaar	caurspidīga	skaidrus						
58590			5	12	G4	33	9	19,5 ^{±0,25}	60	2000	1/20	1	509500	5994100095002	
												500 bulk	1	211155	-
58600			10	12	G4	33	9	19,5 ^{±0,25}	140	2000	1/20	1	509501	5994100095019	
												50 bulk	1	211255	-

bányalámpákhoz ● pro důlní lampy ● pre banské svietidlá
pentru lămpi de mină ● za rudarske lampe ● за рударски лампи ● за миньорски фенерчета
kaevurilampidele ● ogjraču lampām ● kalnakasių lempoms

világos	čirá	čira	clar	bistra	просирна	прозрачна	klaar	caurspidīga	skaidrus					
58790			4,0	4,0	Px13,5s	31	10	6,35 ^{±0,25}	50	400	1/20	2	510637	5994100106371
58810			(0,67A)	4,0	Px13,5s	31	10	6,35 ^{±0,25}	32	600	1/20	2	510638	5994100106388

zseblámpákhoz ● pro kapesní svítilny ● pre vreckové svietidlá
pentru lanterne ● za baterijske lampe ● за батериски лампи ● за джобни фенерчета
taskulampidele ● kabatas baterijām ● žibintuvėlams

világos	čirá	čira	clar	bistra	просирна	прозрачна	klaar	caurspidīga	skaidrus						
58720			(0,85A)	2,8	Px13,5s	31	10	6,35 ^{±0,25}	35	10	1/20	2	510633	5994100106333	
58740			(0,85A)	4,0	Px13,5s	31	10	6,35 ^{±0,25}	60	25	1/20	2	510634	5994100106340	
58760			(0,85A)	5,2	Px13,5s	31	10	6,35 ^{±0,25}	85	25	1/20	2	510635	5994100106357	
												500 bulk	2	211806	-
58710			(0,85A)	7,2	Px13,5s	31	10	6,35 ^{±0,25}	125	50	1/20	2	510636	5994100106364	
58830			(0,85A)	2,8	E10	31	10	20,8 ^{±1}	36	10	1/20	3	510647	5994100106470	
58850			(0,85A)	4,0	E10	31	10	20,8 ^{±1}	62	25	1/20	3	510645	5994100106456	
58860			(0,5A)	5,2	E10	31	10	20,8 ^{±1}	50	15	1/20	3	510646	5994100106463	
58870			(0,85A)	5,2	E10	31	10	20,8 ^{±1}	90	25	1/20	3	510644	5994100106449	

Két végén fejezt, hálózati feszültségű halogénlámpák
Oboustranně patičované halogenové žárovky na síťové napětí
Obojstranne päťicované halogénové žiarovky na sieťové napätie

Lāmpī halogene cu racord la ambele capete
Halogene sijalice sa dva podnožja za mrežni napon
Двострани халогени сијалици за мрежен напон
Халогенни лампи с двустранен цокъл за мрежово напрежение

Kahesoklilised võrgupingel töötavad halogeenlambid
Pamat sprieguma halogēnās spuldzes
Elektros tinklo įtampos halogeninės lemputės su išvadais abiejuose galuose

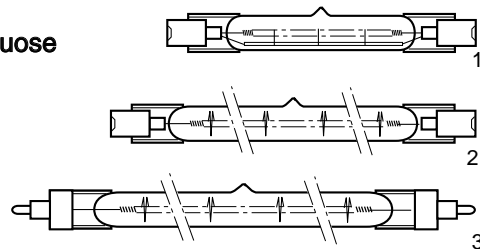

Type	W	V		L _{max.}	Ø	Im	t _(h)		EEC	Fig.	SKU	EAN
világos ● čirá ● číra ● clar ● bistra ● просирна ● прозрачна ● klaar ● caurspidīga ● skaidrus												
51780	100	230	R7s	78,3	10	1600	2000	1/10	D	1	509453	5994100094531
51110	150	230	R7s	78,3	10	2600	2000	1/10	D	1	509454	5994100094548
50080	200	240	R7s	78,3	10	2600	2000	1/10	D	1	509455	5994100094550
		230	R7s	78,3	10	3400	2000	1/10	D	1	509457	5994100094579
50080	200	240	R7s	78,3	10	3400	2000	1/10	D	1	509458	5994100094586
		230	R7s	78,3	10	3400	2000	1/10	D	1	509458	5994100094586
51820	150	230	R7s	117,6	8	2100	2000	1/10	E	2	509459	5994100094593
50250	200	240	R7s	117,6	8	2100	2000	1/10	E	2	509460	5994100094609
		230	R7s	117,6	8	3100	2000	1/10	E	2	509462	5994100094623
50090	250	240	R7s	117,6	8	3100	2000	1/10	E	2	509463	5994100094630
		230	R7s	117,6	8	4000	2000	1/10	E	2	510629	5994100106296
51000	300	240	R7s	117,6	8	4000	2000	1/10	E	2	510630	5994100106302
		130	R7s	117,6	8	5950	2000	1/10	D	2	174052	0721365658001
51020	300	230	R7s	117,6	8	5100	2000	1/10	E	2	509467	5994100094678
50010	500	240	R7s	117,6	8	5100	2000	1/10	E	2	509469	5994100094692
		130	R7s	117,6	10	11000	2000	1/10	-	2	174320	0721365658025
50000	500	230	R7s	117,6	10	9800	2000	1/10	-	2	509470	5994100094708
50020	1000	240	R7s	117,6	10	9500	2000	1/10	-	2	509471	5994100094715
		230	R7s	189,1	10	21000	2000	1/10	-	2	509473	5994100094739
51770	1000	240	R7s	189,1	10	21000	2000	1/10	-	2	509472	5994100094722
		230	R7s	189,1	10	21000	2000	1/10	-	2	509472	5994100094722
51770	1000	240	R7s	254,1	10	21000	2000	1/10	-	2	510631	5994100106319
50030	1500	230	R7s	254,1	10	32000	2000	1/10	-	2	509474	5994100094746
		240	R7s	254,1	10	32000	2000	1/10	-	2	509475	5994100094753
51700	2000	230	R7s	330,8	10	44000	2000	1/10	-	2	510632	5994100106326
K6/Q2000 T3/CL	2000	230	Fa4	333,0	10	44000	2000	1/10	-	3	29190	9004102291909

Halogen IR™*

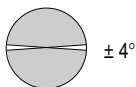

K9-Q225 T3/230 HIR	225	230	R7s	117	10	4800	2000	1/10	C	4	91515	9004102315773
K1-Q375 T3/230 HIR	375	230	R7s	117	10	9000	2000	1/10	C	4	31598	9004102315988

* Bura: az infravörös sugárzást az izzószála visszaverő réteggel bevont üveg.
 * Baňka: vnitřní povrch baňky pokrytý vrstvou pro odraz infračerveného záření zpět na spirálu.
 * Banka: vnútorný povrch banky pokrytý vrstvou pre odraz infračerveného žiarenia späť na spirálu.
 * Balon: sticlić cu strat reflectorizant infrarošu care reflectă radiațiile pe firul incandescent.
 * Balon: presvučena specijalnim tankim IC premazom, koji veći deo toplote reflektuje nazad na vlakno.
 * Балон: премачкана со специјален инфрацрвен слој кој поголемиот дел од топлината го рефлектира назад на влакното.
 * Колба: от стъкло със специален инфрачервен слой, който отразява топлината обратно назад към жичката.
 * Kolvi sisepind on kaetud patenteeritud õhukese IR kihiga mis peegeldab soojust tagasi hõõgniidile.
 * Kolba: päkläräta ar patentētu IR plēvi, kas atstaro lielu siltuma daļu atpakaļ kvēldieģā.
 * Korpusas: Lemputė padengta plona patentuota IR spindulius atspindinčia plėvele, kuri didžiąją šilumos dalį atspindi atgal į siūlą.

Egy végén fejelt, hálózati feszültségű halogénlámpák
Jednopolicové halogenové žárovky na síťové napětí
Jednostranne päťcované halogénové žiarovky na sieťové napätie

Lămpi halogene cu racord la un capăt
Halogene sijalice sa jednim podnožjom za mrežni napon
Еднострани халогени сијалици за мрежен напон
Халогенни лампи с едностранен цокъл за мрежово напрежение

Ûhe sokliga võrgupingel töötavad halogeenlambid
Zemsprieguma divkontakta halogēnspuldzes
Elektros tinklo ļatapos halogeninēs lemputēs su viename gale

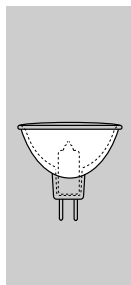
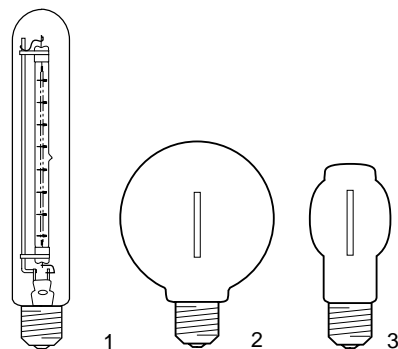

Type	W	V		L _{max.}	∅	lm	CCT	t _(h)		EEC	Fig.	SKU	EAN
------	---	---	--	-------------------	---	----	-----	------------------	--	-----	------	-----	-----

Halo T

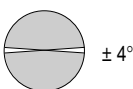

	világos ●	čirá ●	čira ●	clar ●	bistra ●	просирна ●	прозрачна ●	klaar ●	caurspidīga ●	skaidrus			
51010	500	230	E40	215	38	9500	2900	2000	1/10	-	1	510650	5994100106500
		240	E40	215	38	9500	2900	2000	1/10	-	1	510648	5994100106487
51030	1000	230	E40	280	38	21000	2850	2000	1/10	-	1	510651	5994100106517



HaloGlobe™



	fehér ●	bílá ●	biela ●	alb ●	bela ●	бела ●	бяла ●	valge ●	balta ●	balta			
HaloG95/60W/W 230V E27	60	230	E27	138,5	95	700	2850	2000	1/10	E	2	92534	9004102320265
HaloG95/100W/W 230V E27	100	230	E27	138,5	95	1350	2850	2000	1/10	E	2	92535	9004102320326
HaloG95/150W/W 230V E27	150	230	E27	138,5	95	2000	2850	2000	1/10	E	2	92536	9004102320357



Halo BTT™



	világos ●	čirá ●	čira ●	clar ●	bistra ●	просирна ●	прозрачна ●	klaar ●	caurspidīga ●	skaidrus			
HaloBTT/60W/CL 230V E27	60	230	E27	118	47	820	2850	2000	1/10	D	3	90779	0043168907798
HaloBTT/100W/CL 230V E27	100	230	E27	118	47	1550	2850	2000	1/10	D	3	90780	0043168907804
HaloBTT/150W/CL 230V E27	150	230	E27	118	47	2600	2850	2000	1/10	D	3	90781	0043168907811
	fehér ●	bílá ●	biela ●	alb ●	bela ●	бела ●	бяла ●	valge ●	balta ●	balta			
HaloBTT/60W/W 230V E27	60	230	E27	118	47	700	2850	2000	1/10	E	3	90299	9004102354109
HaloBTT/100W/W 230V E27	100	230	E27	118	47	1350	2850	2000	1/10	E	3	90308	9004102354031
HaloBTT/150W/W 230V E27	150	230	E27	118	47	2600	2850	2000	1/10	E	3	90310	9004102353997



Halogén közlekedési jelzőlámpák
Halogenové žárovky pro dopravní signalizaci
Halogénové žiarovky pre dopravnú signalizáciu

Lămpi halogene pentru semnalizatoare de circulație
Halogene sijalice za saobraćajnu signalizaciju
Халогени сијалици за саобраќајна сигнализација
Халогенни лампи за пътна сигнализација

Valgusfoori halogeenlambid
Halogēnspuldzes luksoforiem
Halogeninēs šviesoforu lemputēs

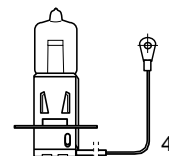

Type	W	V		L _{max.}	∅	LCL	lm	t _(h)		EEC	Fig.	SKU	EAN
------	---	---	--	-------------------	---	-----	----	------------------	--	-----	------	-----	-----

52160	50	10	PKX22s	42	11,5	18	940	8000	400 bulk	C	4	208652	-
-------	----	----	--------	----	------	----	-----	------	----------	---	---	--------	---



Halogén PAR lámpák
Halogenové žárovky PAR
Halogénové žiarovky PAR

Lāmpi halogene PAR
PAR halogene sijalice
PAR халогени сијалици
PAR халогенни лампи

PAR halogeenlambid
PAR halogēnspuldzes
PAR halogeninēs lemputēs

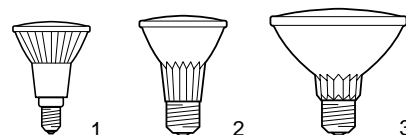

Type	W	V		L _{max.}	∅	Cd	CCT		t _(h)		Fig.	SKU	EAN
------	---	---	--	-------------------	---	----	-----	--	------------------	--	------	-----	-----

PAR 16

FLOOD

vilāgos ● čirā ● čira ● clar ● bistra ● просирна ● прозрачна ● klaar ● caurspidīga ● skaidrus

40PAR16/230/FL	40	230	E14	79	50	950	2900	25	2000	1/15	1	92697	0043168926973
----------------	----	-----	-----	----	----	-----	------	----	------	------	---	-------	---------------



PAR 16 Start

FLOOD

vilāgos ● čirā ● čira ● clar ● bistra ● просирна ● прозрачна ● klaar ● caurspidīga ● skaidrus

50PAR16/230/FL	50	230	E14	79	50	800	2700	36	1500	1/10	1	92823	0043168928236
----------------	----	-----	-----	----	----	-----	------	----	------	------	---	-------	---------------



PAR 20

SPOT

vilāgos ● čirā ● čira ● clar ● bistra ● просирна ● прозрачна ● klaar ● caurspidīga ● skaidrus

50PAR20/230/SP	50	230	E27	88	65	3000	2900	10	2000	1/10	2	34863	0043168348638
----------------	----	-----	-----	----	----	------	------	----	------	------	---	-------	---------------



FLOOD

vilāgos ● čirā ● čira ● clar ● bistra ● просирна ● прозрачна ● klaar ● caurspidīga ● skaidrus

50PAR20/230/FL	50	230	E27	88	65	1000	2900	25	2500	1/10	2	34866	0043168348669
----------------	----	-----	-----	----	----	------	------	----	------	------	---	-------	---------------

PAR 25

SPOT

vilāgos ● čirā ● čira ● clar ● bistra ● просирна ● прозрачна ● klaar ● caurspidīga ● skaidrus

50PAR25/230/SP	50	230	E27	108	81	4000	2900	10	2500	1/15	2	91776	0043168917766
----------------	----	-----	-----	-----	----	------	------	----	------	------	---	-------	---------------



75PAR25/230/SP	75	230	E27	108	81	5500	2900	10	3000	1/15	2	91777	0043168917773
----------------	----	-----	-----	-----	----	------	------	----	------	------	---	-------	---------------

FLOOD

vilāgos ● čirā ● čira ● clar ● bistra ● просирна ● прозрачна ● klaar ● caurspidīga ● skaidrus

50PAR25/230/FL	50	230	E27	108	81	1100	2900	25	2500	1/15	2	91774	0043168917742
----------------	----	-----	-----	-----	----	------	------	----	------	------	---	-------	---------------

75PAR25/230/FL	75	230	E27	108	81	1300	2900	25	3000	1/15	2	91775	0043168917759
----------------	----	-----	-----	-----	----	------	------	----	------	------	---	-------	---------------

PAR 30

SPOT

vilāgos ● čirā ● čira ● clar ● bistra ● просирна ● прозрачна ● klaar ● caurspidīga ● skaidrus

75PAR30/230/SP	75	230	E27	90,5	97	6900	2900	10	3000	1/15	3	32465	5021731324659
----------------	----	-----	-----	------	----	------	------	----	------	------	---	-------	---------------



100PAR30/230/SP	100	230	E27	90,5	97	10000	2900	10	3000	1/15	3	32483	5021731324833
-----------------	-----	-----	-----	------	----	-------	------	----	------	------	---	-------	---------------

FLOOD

vilāgos ● čirā ● čira ● clar ● bistra ● просирна ● прозрачна ● klaar ● caurspidīga ● skaidrus

75PAR30/230/FL	75	230	E27	90,5	97	2200	2900	30	3000	1/15	3	32463	5021731324635
----------------	----	-----	-----	------	----	------	------	----	------	------	---	-------	---------------

100PAR30/230/FL	100	230	E27	90,5	97	3500	2900	30	3000	1/15	3	32484	5021731324840
-----------------	-----	-----	-----	------	----	------	------	----	------	------	---	-------	---------------

Starcoat™ T5 nagy fényhasznosítású, háromsávós fénycsövek*

Starcoat™ T5 třípásmové zářivky s vysokým výkonem*

Trojpásmové žiarivky Starcoat™ T5 s vysokou účinnosťou*

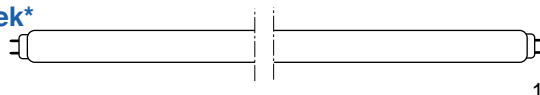

1

Starcoat™ T5 lámpa fluorescente cu trei benzi cu Eficiență Ridicăată*

Starcoat™ T5 visoko efikasne Trifosforne fluorescentne cevi*

Starcoat™ T5 крайно ефикасни Трифосфорни флуоресцентни цевки*

Високоэффективни трифосфорни луминисцентни тръби Starcoat™ T5*

Starcoat™ T5 suure valgusviljakusega kolmekordse fosforkihiga luminescentslambid*

Starcoat™ T5 augstas efektivitātes trīsfosfora fluorescences spuldzes*

Starcoat™ T5 didelio efektyvumo lempos su trisluoksne liuminoforo danga*

T5 Ø 16 mm

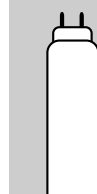

Type	W	L _{max.}	lm	CCT	Ra	t _(h)		EEC	Fig.	SKU	EAN
F14W/827/STARCOAT	14	549	1350	2700	85	20000	1/30	B	1	90230	0043168902304
F14W/830/STARCOAT	14	549	1350	3000	85	20000	1/30	B	1	90239	0043168902397
F14W/835/STARCOAT	14	549	1350	3500	85	20000	1/30	B	1	90246	0043168902465
F14W/840/STARCOAT	14	549	1350	4000	85	20000	1/30	B	1	90247	0043168902472
F14W/865/STARCOAT	14	549	1350	6500	85	20000	1/30	B	1	90244	0043168902441
F21W/827/STARCOAT	21	849	2100	2700	85	20000	1/30	B	1	90245	0043168902458
F21W/830/STARCOAT	21	849	2100	3000	85	20000	1/30	B	1	90248	0043168902489
F21W/835/STARCOAT	21	849	2100	3500	85	20000	1/30	B	1	90249	0043168902496
F21W/840/STARCOAT	21	849	2100	4000	85	20000	1/30	B	1	90250	0043168902502
F21W/865/STARCOAT	21	849	2100	6500	85	20000	1/30	B	1	90251	0043168902519
F28W/827/STARCOAT	28	1149	2900	2700	85	20000	1/30	B	1	90252	0043168902526
F28W/830/STARCOAT	28	1149	2900	3000	85	20000	1/30	B	1	90253	0043168902533
F28W/835/STARCOAT	28	1149	2900	3500	85	20000	1/30	B	1	90254	0043168902540
F28W/840/STARCOAT	28	1149	2900	4000	85	20000	1/30	B	1	90255	0043168902557
F28W/865/STARCOAT	28	1149	2900	6500	85	20000	1/30	B	1	90256	0043168902564
F35W/827/STARCOAT	35	1449	3650	2700	85	20000	1/30	B	1	90257	0043168902571
F35W/830/STARCOAT	35	1449	3650	3000	85	20000	1/30	B	1	90258	0043168902588
F35W/835/STARCOAT	35	1449	3650	3500	85	20000	1/30	B	1	90259	0043168902595
F35W/840/STARCOAT	35	1449	3650	4000	85	20000	1/30	B	1	90260	0043168902601
F35W/865/STARCOAT	35	1449	3650	6500	85	20000	1/30	B	1	90261	0043168902618
F14W/827/STARCOAT	14	549	1350	2700	85	20000	40 bulk	B	1	39965	0043168399654
F14W/830/STARCOAT	14	549	1350	3000	85	20000	40 bulk	B	1	39964	0043168399647
F14W/835/STARCOAT	14	549	1350	3500	85	20000	40 bulk	B	1	39961	0043168399616
F14W/840/STARCOAT	14	549	1350	4000	85	20000	40 bulk	B	1	39973	0043168399739
F14W/865/STARCOAT	14	549	1350	6500	85	20000	40 bulk	B	1	90222	0043168902229
F21W/827/STARCOAT	21	849	2100	2700	85	20000	40 bulk	B	1	39975	0043168399752
F21W/830/STARCOAT	21	849	2100	3000	85	20000	40 bulk	B	1	39976	0043168399760
F21W/835/STARCOAT	21	849	2100	3500	85	20000	40 bulk	B	1	39977	0043168399777
F21W/840/STARCOAT	21	849	2100	4000	85	20000	40 bulk	B	1	39978	0043168399784
F21W/865/STARCOAT	21	849	2100	6500	85	20000	40 bulk	B	1	39979	0043168399791
F28W/827/STARCOAT	28	1149	2900	2700	85	20000	40 bulk	B	1	39980	0043168399807
F28W/830/STARCOAT	28	1149	2900	3000	85	20000	40 bulk	B	1	39982	0043168399821
F28W/835/STARCOAT	28	1149	2900	3500	85	20000	40 bulk	B	1	39983	0043168399838
F28W/840/STARCOAT	28	1149	2900	4000	85	20000	40 bulk	B	1	39984	0043168399845
F28W/865/STARCOAT	28	1149	2900	6500	85	20000	40 bulk	B	1	39985	0043168399852
F35W/827/STARCOAT	35	1449	3650	2700	85	20000	40 bulk	B	1	39986	0043168399869
F35W/830/STARCOAT	35	1449	3650	3000	85	20000	40 bulk	B	1	39989	0043168399890
F35W/835/STARCOAT	35	1449	3650	3500	85	20000	40 bulk	B	1	39990	0043168399906
F35W/840/STARCOAT	35	1449	3650	4000	85	20000	40 bulk	B	1	39991	0043168399913
F35W/865/STARCOAT	35	1449	3650	6500	85	20000	40 bulk	B	1	39992	0043168399920

* Nagyfrekvenciás elektronikus előtétrel üzemeltetendő.

* Provozovatelné na vysokofrekvenčních předřadnicích.

* Превádzkovateľné z vysokofrekvenčných predradníkov.

* Se foliosesc numai cu balast HF.

* Za upotrebu sa visokofrekventnim elektronskim balastom.

* Да се употребува со високофреквентен електронски баласт.

* За употреба с високофреквентен електронен баласт.

* Kasutamiseks elektroonilise süüteseadmega.

* Eksploatacijai ar augstas frekvences elektroniskajām drošelēm.

* Naudoti tik elektronini balasta.



Starcoat™ T5 nagy fényáramú, háromsávós fénycsövek*

Starcoat™ třípásmové zářivky s vysokým světelným tokem*

Trojpásmové žiarivky Starcoat™ T5 s vysokým svetelným tokom*



1

Starcoat™ lámpy fluorescente cu trei benzi cu Flux Luminos Mărit*

Starcoat™ T5 povečani osvetljaj Trifosforne fluorescentne cevi*

Starcoat™ високо продуктивни Трифосфорни флуоресцентни цевки*

Високопродуктивни трифосфорни луминисцентни тръби Starcoat™ T5*

Starcoat™ suure valgusvooga kolmekordse fosforkihiga luminescentslambid*

Starcoat™ T5 augstas intensitātes trīsfosfora fluorescences spuldzes*

Starcoat™ T5 didelio šviesos srauto lempos su trisluoksne liuminofo ro danga*

T5 Ø 16 mm



Type	W	L _{max.}	Im	CCT	Ra	t _(h)		EEC	Fig.	SKU	EAN
F24W/827/STARCOAT	24	549	2000	2700	85	20000	1/30	B	1	90262	0043168902625
F24W/830/STARCOAT	24	549	2000	3000	85	20000	1/30	B	1	90263	0043168902632
F24W/835/STARCOAT	24	549	2000	3500	85	20000	1/30	B	1	90264	0043168902649
F24W/840/STARCOAT	24	549	2000	4000	85	20000	1/30	B	1	90265	0043168902656
F24W/865/STARCOAT	24	549	2000	6500	85	20000	1/30	B	1	90266	0043168902663
F39W/827/STARCOAT	39	849	3500	2700	85	20000	1/30	B	1	90267	0043168902673
F39W/830/STARCOAT	39	849	3500	3000	85	20000	1/30	B	1	90268	0043168902687
F39W/835/STARCOAT	39	849	3500	3500	85	20000	1/30	B	1	90269	0043168902694
F39W/840/STARCOAT	39	849	3500	4000	85	20000	1/30	B	1	90270	0043168902700
F39W/865/STARCOAT	39	849	3500	6500	85	20000	1/30	B	1	90271	0043168902717
F49W/827/STARCOAT	49	1149	4900	2700	85	20000	1/30	B	1	90277	0043168902724
F49W/830/STARCOAT	49	1149	4900	3000	85	20000	1/30	B	1	90278	0043168902731
F49W/835/STARCOAT	49	1149	4900	3500	85	20000	1/30	B	1	90279	0043168902748
F49W/840/STARCOAT	49	1149	4900	4000	85	20000	1/30	B	1	90280	0043168902755
F49W/865/STARCOAT	49	1149	4900	6500	85	20000	1/30	B	1	90281	0043168902762
F54W/827/STARCOAT	54	1149	5000	2700	85	20000	1/30	B	1	90272	0043168902779
F54W/830/STARCOAT	54	1149	5000	3000	85	20000	1/30	B	1	90273	0043168902786
F54W/835/STARCOAT	54	1149	5000	3500	85	20000	1/30	B	1	90274	0043168902793
F54W/840/STARCOAT	54	1149	5000	4000	85	20000	1/30	B	1	90275	0043168902809
F54W/865/STARCOAT	54	1149	5000	6500	85	20000	1/30	B	1	90276	0043168902816
F80W/827/STARCOAT	80	1149	7000	2700	85	20000	1/30	B	1	90282	0043168902823
F80W/830/STARCOAT	80	1149	7000	3000	85	20000	1/30	B	1	90283	0043168902830
F80W/835/STARCOAT	80	1149	7000	3500	85	20000	1/30	B	1	90284	0043168902847
F80W/840/STARCOAT	80	1149	7000	4000	85	20000	1/30	B	1	90285	0043168902854
F80W/865/STARCOAT	80	1149	7000	6500	85	20000	1/30	B	1	90286	0043168902861
F24W/827/STARCOAT	24	549	2000	2700	85	20000	40 bulk	B	1	39994	0043168399944
F24W/830/STARCOAT	24	549	2000	3000	85	20000	40 bulk	B	1	39998	0043168399982
F24W/835/STARCOAT	24	549	2000	3500	85	20000	40 bulk	B	1	90196	0043168901963
F24W/840/STARCOAT	24	549	2000	4000	85	20000	40 bulk	B	1	90197	0043168901970
F24W/865/STARCOAT	24	549	2000	6500	85	20000	40 bulk	B	1	90198	0043168901987
F39W/827/STARCOAT	39	849	3500	2700	85	20000	40 bulk	B	1	90200	0043168902007
F39W/830/STARCOAT	39	849	3500	3000	85	20000	40 bulk	B	1	90201	0043168902014
F39W/835/STARCOAT	39	849	3500	3500	85	20000	40 bulk	B	1	90202	0043168902021
F39W/840/STARCOAT	39	849	3500	4000	85	20000	40 bulk	B	1	90203	0043168902038
F39W/865/STARCOAT	39	849	3500	6500	85	20000	40 bulk	B	1	90204	0043168902045
F49W/827/STARCOAT	49	1149	4900	2700	85	20000	40 bulk	B	1	90205	0043168902052
F49W/830/STARCOAT	49	1149	4900	3000	85	20000	40 bulk	B	1	90232	0043168902328
F49W/835/STARCOAT	49	1149	4900	3500	85	20000	40 bulk	B	1	90206	0043168902069
F49W/840/STARCOAT	49	1149	4900	4000	85	20000	40 bulk	B	1	90209	0043168902090
F49W/865/STARCOAT	49	1149	4900	6500	85	20000	40 bulk	B	1	90211	0043168902113
F54W/827/STARCOAT	54	1149	5000	2700	85	20000	40 bulk	B	1	90220	0043168902205
F54W/830/STARCOAT	54	1149	5000	3000	85	20000	40 bulk	B	1	90219	0043168902199
F54W/835/STARCOAT	54	1149	5000	3500	85	20000	40 bulk	B	1	90221	0043168902212
F54W/840/STARCOAT	54	1149	5000	4000	85	20000	40 bulk	B	1	90223	0043168902236
F54W/865/STARCOAT	54	1149	5000	6500	85	20000	40 bulk	B	1	90224	0043168902243
F80W/827/STARCOAT	80	1149	7000	2700	85	20000	40 bulk	B	1	90225	0043168902250
F80W/830/STARCOAT	80	1149	7000	3000	85	20000	40 bulk	B	1	90226	0043168902267
F80W/835/STARCOAT	80	1149	7000	3500	85	20000	40 bulk	B	1	90227	0043168902274
F80W/840/STARCOAT	80	1149	7000	4000	85	20000	40 bulk	B	1	90228	0043168902281
F80W/865/STARCOAT	80	1149	7000	6500	85	20000	40 bulk	B	1	90229	0043168902298

* Nagyfrekvenciás elektronikus elctétronál üzemeltetendők.

* Provozovatelné na vysokofrekvenčních předradnicích.

* Prevádzkovateľné z vysokofrekvenčných predradníkov.

* Se foliosesc numai cu balast HF.

* Za upotrebu sa visokofrekventnim elektronskim balastom.

* Да се употребува со високофреквентен електронски баласт.

* За употреба с високофреквентен електронен баласт.

* Kasutamiseks elektroonilise süüteseadmega.

* Eksploatacijai ar augstas frekvences elektroniskajām drošeslēm.

* Naudoti tik elektroninį balastą.



T5 standard halofoszfátos fénycsövek

Halofosfátové zářivky T5

Halofosfátové žiarivky T5

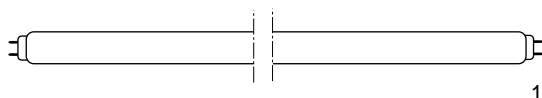

1

Tuburi fluorescente T5 standard

T5 standardne Halofosfatne fluorescentne cevi

T5 стандартни Халофосфатни флуоресцентни цевки

Стандартни луминисцентни тръби T5

T5 halofosfor luminescentslambid

T5 halofosfáta fluorescences spuldzes

Miniatiürinés fluorescencinés lempos

T5 Ø 16 mm



Type	W	L _{max.}	Im	CCT	Ra	t _(h)		EEC	Fig.	SKU	EAN
F4W/33	4	150	150	4000	58	5000	1/25	B	1	39441	0043168394413
F4W/35	4	150	150	3450	54	5000	1/25	B	1	39446	0043168394468
F6W/33	6	225	260	4000	58	5000	1/25	B	1	39445	0043168394451
F6W/35	6	225	260	3450	54	5000	1/25	B	1	39442	0043168394420
F8W/29	8	300	385	2950	51	5000	1/25	B	1	37754	5021731295133
F8W/33	8	300	380	4000	58	5000	1/25	B	1	37755	5021731295126
F8W/33BP	8	300	380	4000	58	5000	100	B	1	37001	-
F8W/35	8	300	400	3450	54	5000	1/25	B	1	37756	5021731295140
F8W/35BP	8	300	400	3450	54	5000	100	B	1	37006	-
F13W/29	13	525	850	2950	51	5000	1/25	B	1	39437	0043168394376
F13W/33	13	525	800	4000	58	5000	1/25	B	1	39440	0043168394406
F13W/35	13	525	850	3450	54	5000	1/25	B	1	39439	0043168394390



T5 UV típusok

T5 UV typu

T5 UV typy

Tuburi fluorescente T5 UV

T5 UV fluorescentne cevi

T5 UV видови

T5 UV типове

T5 UV luminescentslambid

T5 UV fluorescences spuldzes

T5 UV spindulių fluorescencinés lempos

F4T5BLB	4	150	-	-	-	5000	1/25	-	1	39882	0043168398824
F6T5BLB	6	225	-	-	-	5000	1/25	-	1	39883	0043168398831
F8T5BLB	8	300	-	-	-	5000	1/25	-	1	39884	0043168398848

Háromszávos fénycsövek
Třípásmové zářivky
Trojčásmové žiarivky

Tuburi fluorescente cu trei benzi
Fluorescentne cevi trifosforne
Трифосфорни флуоресцентни цевки
Триивични луминисцентни тръби

Kolmekordse fosforkihiga luminescentslambid
Fluorescences spuldzes ar trifosfora pārklājumu
Fluorescencinēs lempas su trisluksne danga

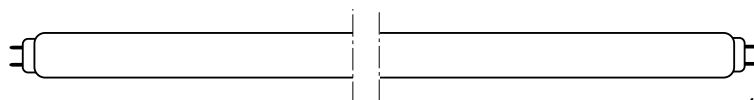

1

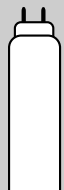

T8 Ø 26 mm

Type	W	L _{max.}	lm	CCT	Ra	*t _(h)	**t _(h)		EEC	Fig.	SKU	EAN
------	---	-------------------	----	-----	----	-------------------	--------------------	--	-----	------	-----	-----

T8 Cov-R-Guard™

polikarbonát bevonattal ● s polykarbonátovým povlakem ● s polykarbonátovým povlakom
cu înveliș din policarbonat ● sa polikarbonat oblogom ● со Поликарбонатна облога ● с поликарбонатен щит
polükarbonaat kaitseümbrisega ● ar polikarbonāta apvalku ● su polikarbonato danga

F18W/830/CVG/XLRCov-R-Guard XLR	18	600	1300	2950	85	15000	20000	1/25	A	1	39537	–
F18W/835/CVG/XLRCov-R-Guard XLR	18	600	1300	3400	85	15000	20000	1/25	A	1	39538	–
F18W/840/CVG/XLRCov-R-Guard XLR	18	600	1300	4000	85	15000	20000	1/25	A	1	39539	–
F36W/830/CVG/XLRCov-R-Guard XLR	36	1200	3250	2950	85	15000	20000	1/25	A	1	39540	–
F36W/835/CVG/XLRCov-R-Guard XLR	36	1200	3250	3400	85	15000	20000	1/25	A	1	39541	–
F36W/840/CVG/XLRCov-R-Guard XLR	36	1200	3250	4000	85	15000	20000	1/25	A	1	39543	–
F58W/830/CVG/XLRCov-R-Guard XLR	58	1500	5050	2950	85	15000	20000	1/25	A	1	39544	–
F58W/835/CVG/XLRCov-R-Guard XLR	58	1500	5050	3400	85	15000	20000	1/25	A	1	39545	–
F58W/840/CVG/XLRCov-R-Guard XLR	58	1500	5050	4000	85	15000	20000	1/25	A	1	39546	–
F70W/830/CVG/XLRCov-R-Guard XLR	70	1800	6100	2950	85	15000	20000	1/25	A	1	39548	–
F70W/835/CVG/XLRCov-R-Guard XLR	70	1800	6100	3400	85	15000	20000	1/25	A	1	39549	–
F70W/840/CVG/XLRCov-R-Guard XLR	70	1800	6100	4000	85	15000	20000	1/25	A	1	39550	–

T8 Polylux XL_R™

F18W/827/XLR	18	600	1350	2700	85	15000	20000	1/25	A	1	37551	0043168375511
F18W/830/XLR	18	600	1350	2950	85	15000	20000	1/25	A	1	37552	0043168375528
F18W/835/XLR	18	600	1350	3400	85	15000	20000	1/25	A	1	37613	0043168376136
F18W/840/XLR	18	600	1350	4000	85	15000	20000	1/25	A	1	37553	0043168375535
F30W/827/XLR	30	900	2450	2700	85	15000	20000	1/25	A	1	39448	0043168394482
F30W/830/XLR	30	900	2450	2950	85	15000	20000	1/25	A	1	39453	0043168394536
F30W/840/XLR	30	900	2450	4000	85	15000	20000	1/25	A	1	39449	0043168394499
F36W/827/XLR	36	1200	3350	2700	85	15000	20000	1/25	A	1	37554	0043168375542
F36W/830/XLR	36	1200	3350	2950	85	15000	20000	1/25	A	1	37555	0043168375559
F36W/835/XLR	36	1200	3350	3400	85	15000	20000	1/25	A	1	37614	0043168376143
F36W/840/XLR	36	1200	3350	4000	85	15000	20000	1/25	A	1	37556	0043168375566
F58W/827/XLR	58	1500	5200	2700	85	15000	20000	1/25	A	1	37557	0043168375573
F58W/830/XLR	58	1500	5200	2950	85	15000	20000	1/25	A	1	37558	0043168375580
F58W/835/XLR	58	1500	5200	3400	85	15000	20000	1/25	A	1	37615	0043168376150
F58W/840/XLR	58	1500	5200	4000	85	15000	20000	1/25	A	1	37559	0043168375597
F70W/830/XLR	70	1800	6300	2950	85	15000	20000	1/25	A	1	39450	0043168394505
F70W/835/XLR	70	1800	6300	3400	85	15000	20000	1/25	A	1	39451	0043168394512
F70W/840/XLR	70	1800	6300	4000	85	15000	20000	1/25	A	1	39452	0043168394529

* hagyományos előtétellel ** nagyfrekvenciás előtétellel
* předradník indukční ** předradník elektronický
* s tradičným predradníkom ** s vysokofrekvenčným predradníkom
* cu balast conventional ** cu balast HF
* sa standardnim balastom ** sa visokofrekventnim elektronskim balastom
* со стандартен баласт ** со електронски баласт
* със стандартен баласт ** със електронен баласт
* tavalsé ballastiga ** elektroonilise ballastiga
* ar parastu balastu ** ar elektronisku balastu
* su įprastiniu balastu ** su elektroniniu balastu

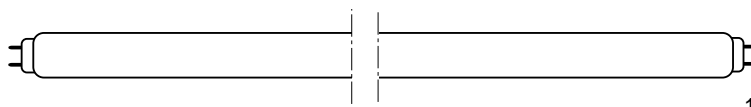

1

T8 Ø 26 mm

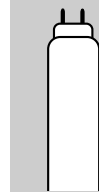

Type	W	L _{max.}	Im	CCT	Ra	*t _(h)	**t _(h)		EEC	Fig.	SKU	EAN
------	---	-------------------	----	-----	----	-------------------	--------------------	--	-----	------	-----	-----

T8 Polylux XL™

F18W/827	18	600	1350	2700	85	15000	18000	1/25	A	1	35426	5021731354267
F18W/830	18	600	1350	2950	85	15000	18000	1/25	A	1	35427	5021731354274
F18W/835	18	600	1350	3400	85	15000	18000	1/25	A	1	35428	5021731354281
F18W/840	18	600	1350	4000	85	15000	18000	1/25	A	1	35429	5021731354298
F18W/860	18	600	1300	6300	85	15000	18000	1/25	A	1	34492	0043168344920
F30W/827	30	900	2450	2700	85	15000	18000	1/25	A	1	35575	5021731355752
F30W/830	30	900	2450	2950	85	15000	18000	1/25	A	1	35576	5021731355769
F30W/840	30	900	2450	4000	85	15000	18000	1/25	A	1	35577	5021731355776
F36WM/830	36	970	3100	2950	85	15000	18000	1/25	A	1	92522	0043168925228
F36WM/840	36	970	3100	4000	85	15000	18000	1/25	A	1	92523	0043168925235
F36W/827	36	1200	3350	2700	85	15000	18000	1/25	A	1	39103	0043168391030
F36W/830	36	1200	3350	2950	85	15000	18000	1/25	A	1	39105	0043168391054
F36W/835	36	1200	3350	3400	85	15000	18000	1/25	A	1	39108	0043168391085
F36W/840	36	1200	3350	4000	85	15000	18000	1/25	A	1	39106	0043168391061
F36W/860	36	1200	3250	6300	85	15000	18000	1/25	A	1	34509	0043168345095
F38W/830	38	1050	3300	2950	85	15000	18000	1/25	A	1	92524	004316833078
F38W/840	38	1050	3300	4000	85	15000	18000	1/25	A	1	92525	004316833085
F58W/827	58	1500	5200	2700	85	15000	18000	1/25	A	1	91452	0043168914529
F58W/830	58	1500	5200	2950	85	15000	18000	1/25	A	1	91453	0043168914536
F58W/835	58	1500	5200	3400	85	15000	18000	1/25	A	1	91454	0043168914543
F58W/840	58	1500	5200	4000	85	15000	18000	1/25	A	1	91455	0043168914550
F58W/860	58	1500	5000	6300	85	15000	18000	1/25	A	1	91457	0043168914574
F70W/830	70	1800	6300	2950	85	15000	18000	1/25	A	1	35578	5021731355783
F70W/835	70	1800	6300	3400	85	15000	18000	1/25	A	1	35579	5021731355790
F70W/840	70	1800	6300	4000	85	15000	18000	1/25	A	1	35580	5021731355806



T8 Polylux XL™ Eco Pack

F18W/830 ECO	18	600	1350	2950	85	15000	18000	1/25	A	1	34841	-
F18W/840 ECO	18	600	1350	4000	85	15000	18000	1/25	A	1	34845	-
F36W/830 ECO	36	1200	3350	2950	85	15000	18000	1/25	A	1	47981	-
F36W/840 ECO	36	1200	3350	4000	85	15000	18000	1/25	A	1	34365	-
F58W/830 ECO	58	1500	5200	2950	85	15000	18000	1/25	A	1	47980	-
F58W/840 ECO	58	1500	5200	4000	85	15000	18000	1/25	A	1	47979	-



T8 Polylux

F15W/827	15	450	1000	2700	80+	12000	-	1/25	B	1	29591	5021731295911
F15W/830	15	450	1000	2950	80+	12000	-	1/25	B	1	29600	5021731296000
F15W/840	15	450	1000	4000	80+	12000	-	1/25	B	1	29603	5021731296031



* hagyományos előtétellel ** nagyfrekvenciás előtétellel

* předradník indukční ** předradník elektronický

* s tradičným predradníkom ** s vysokofrekvenčným predradníkom

* cu balast conventional ** cu balast HF

* sa standardním balastom ** sa visokofrekvenčním elektronickým balastom

* со стандартен баласт ** со електронски баласт

* със стандартен баласт ** със електронен баласт

* tavárise ballastiga ** elektroonilise ballastiga

* ar parastu balastu ** ar elektronisku balastu

* su įprastiniu balastu ** su elektroniniu balastu

T8 standard típusok
Standardní typy
T8 štandardné typy

T8 Tipurile standard
Standardne
Стандардни видови
Стандартни типове

Standardsed
Parastās

Standartiniai tipai

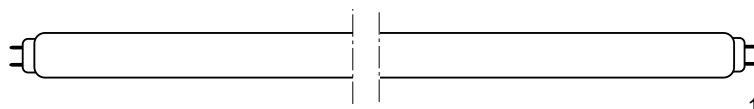

1

T8 Ø 26 mm

Type	W	L _{max.}	lm	CCT	Ra	t _(h)		EEC	Fig.	SKU	EAN
15W F33	15	450	850	4000	58	9000	1/25	B	1	185060	9004100850610
18W F29	18	600	1150	2950	51	9000	1/25	B	1	185276	9004100852713
F33	18	600	1150	4000	58	9000	1/25	B	1	185332	9004100853314
F74	18	590	950	6500	76	9000	1/25	B	1	185550	9004100855516
F36WM/33	36	970	2600	4000	58	9000	1/25	B	1	92518	0043168925181
F36WM/25	36	970	2400	4050	73	9000	1/25	B	1	92517	0043168925174
F36WM/54	36	970	1900	6500	76	9000	1/25	B	1	92519	0043168925198
36W F29	36	1200	2850	2950	51	9000	1/25	B	1	185916	9004100859118
F33	36	1200	2850	4000	58	9000	1/25	B	1	185973	9004100859712
F74	36	1200	2350	6500	76	9000	1/25	B	1	186152	9004100861517
58W F29	58	1500	4600	2950	51	9000	1/25	B	1	186650	9004100866512
F33	58	1500	4600	4000	58	9000	1/25	B	1	187712	9004100877112
F74	58	1500	3750	6500	76	9000	1/25	B	1	190050	9004100900513



Fénycsőgyújtók
Zapalovače k zářivkám
Zapaľovače k žiarivkám

Startere

Starteri

Стартери

Стартери

Starterid

Starteri

Starteriai

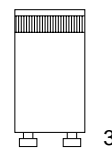

3

4-65 W / 220/240 V	-	-	-	-	-	-	1/25	-	3	400642	9004100702810
4-22 W / 110/130 V	-	-	-	-	-	-	1/25	-	3	400530	9004100702919



T12 standard típusok
Standardní typy
T12 štandardné typy

T12 Tipurile standard
Standardne

Стандартни видове
Стандартни типове

Standardsed
Parastās
Standartiniai tipai

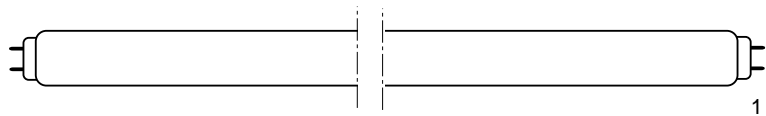

T12 Ø 38 mm

Type	W	L _{max.}	lm	CCT	Ra	t _(h)		EEC	Fig.	SKU	EAN
20W F29	20	600	1150	2950	51	9000	1/25	B	1	182005	9004100820019
F33	20	600	1150	4000	58	9000	1/25	B	1	182037	9004100820316
F74	20	600	950	6500	76	9000	1/25	B	1	511672	5994100116721
40W F29	40	1200	2950	2950	51	9000	1/25	B	1	182756	9004100827513
F33	40	1200	2950	4000	58	9000	1/25	B	1	182827	9004100828213
F74	40	1200	2450	6500	76	9000	1/25	B	1	511671	5994100116714
65W F33	65	1500	4750	4000	58	9000	1/25	B	1	184065	9004100840611
F74	65	1500	3900	6500	76	9000	1/25	B	1	184330	9004100843315
zöld ● zelená ● zelená ● verde ● zelena ● зелена ● зелена ● roheline ● zala ● žalia											
20W	20	600	–	–	–	9000	1/25	–	1	182334	9004100823317
40W	40	1200	–	–	–	9000	1/25	–	1	183264	9004100832616
kék ● modrá ● modrá ● albastru ● plava ● плава ● синя ● sinine ● zila ● mėlyna											
20W	20	600	–	–	–	9000	1/25	–	1	182295	9004100822914
40W	40	1200	–	–	–	9000	1/25	–	1	183226	9004100832210
UV típusok ● UV typy ● UV typy ● Tuburi fluorescente UV ● UV fluorescentne cevi ● UV в видове ● UV типове ● UV luminescentslambid ● UV fluorescences spuldzes ● UV spindulių fluorescencinės lempos											
F20W/BLB	20	600	–	–	–	9000	1/6	–	1	34747	0043168981644
F40W/BLB	40	1200	–	–	–	20000	1/6	–	1	10531	0043168981637



CIRCLINE® körfénycsövek
Kruhové zářivky CIRCLINE®
Kruhové žiarivky CIRCLINE®

Tuburi fluorescente circulare CIRCLINE®
CIRCLINE® prstenaste fluorescentne cevi
CIRCLINE® прстенасти флуоресцентни цевки
CIRCLINE® кръгли луминисцентни тръби

CIRCLINE® luminescentslambid
CIRCLINE® fluorescences spuldzes
CIRCLINE® fluorescencinės lempos

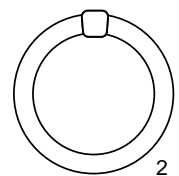

FC8T9/WW	22	209,5	1050	3000	51	12000	1/12	B	2	11023	0043168980456
FC8T9/CW	22	209,5	1000	4150	58	9000	1/30	B	2	92242	0043168980388
FC8T9/D	22	209,5	875	6250	75	9000	1/30	B	2	92243	0043168980449
FC12T9/WW	32	311,2	1875	3000	51	12000	1/12	B	2	11034	0043168980425
FC12T9/CW	32	311,2	1825	4150	62	9000	1/30	B	2	92245	0043168980401
FC12T9/D	32	311,2	1550	6250	75	9000	1/30	B	2	92248	0043168980432
FC16T9/WW	40	412,6	2800	3000	51	12000	1/12	B	2	35275	0043168352758
FC16T9/CW	40	412,6	2700	4150	62	12000	1/12	B	2	35276	0043168352765
FC16T9/D	40	412,6	2500	6250	75	12000	1/12	B	2	35278	0043168352789
FC1660/WW	60	412,6	3700	3000	51	12000	1/12	B	2	29886	–



Kétsőves kompakt fénycővek
Dvoutrubicové kompaktní zářivky
Dvojtrubicové kompaktné žiarivky

Lămpi fluorescente compacte cu două tuburi
Dvocevné kompakt fluorescentne sijalice
Двоцевни компакт флуоресцентни сјаљаци
Двустволни компактни луминисцентни лампи

Kahe toruga kompaktluminescentslambid
Divu cauruļu kompaktās fluorescences spuldzes
Dviejū vamzdeliū kompaktiškos fluorescencinēs lempos

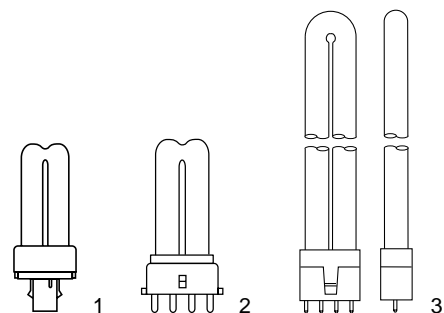
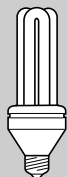

Type	W		L _{max.}	lm	CCT	Ra	t _(h)		EEC	Fig.	SKU	EAN
------	---	--	-------------------	----	-----	----	------------------	--	-----	------	-----	-----

FD & Biax™ S

F5BX/827	5	G23	107,8	265	2700	82	10000	1/10	A	1	37654	0043168376549
F5BX/840	5	G23	107,8	265	4000	82	10000	1/10	A	1	37661	0043168376617
FD7 F82	7	G23	107,8	425	2700	82	10000	1/10	A	1	509983	5994100099833
F7BX/835	7	G23	136,8	425	3500	82	10000	1/10	A	1	37659	0043168376594
FD7 F84	7	G23	136,8	425	4000	82	10000	1/10	A	1	509986	5994100099864
FD7 F865	7	G23	136,8	425	6500	82	10000	1/10	A	1	511236	5994100112365
FD9 F82	9	G23	167,3	600	2700	82	10000	1/10	A	1	509984	5994100099840
F9BX/835	9	G23	167,3	600	3500	82	10000	1/10	A	1	37652	0043168376525
FD9 F84	9	G23	167,3	600	4000	82	10000	1/10	A	1	509985	5994100099857
FD9 F865	9	G23	167,3	600	6500	82	10000	1/10	A	1	511237	5994100112372
FD11 F82	11	G23	237,3	900	2700	82	10000	1/10	A	1	509987	5994100099871
F11BX/835	11	G23	237,3	900	3500	82	10000	1/10	A	1	37666	0043168376662
FD11 F84	11	G23	237,3	900	4000	82	10000	1/10	A	1	510491	5994100104919
FD11 F865	11	G23	237,3	900	6500	82	10000	1/10	A	1	511238	5994100112389

Biax™ S/E

F5BX/827/4P	5	2G7	93,3	265	2700	82	10000	1/10	A	2	37714	0043168377140
F5BX/840/4P	5	2G7	93,3	265	4000	82	10000	1/10	A	2	37715	0043168377157
F7BX/827/4P	7	2G7	122,3	425	2700	82	10000	1/10	A	2	37658	0043168376587
F7BX/840/4P	7	2G7	122,3	425	4000	82	10000	1/10	A	2	37716	0043168377164
F9BX/827/4P	9	2G7	152,8	600	2700	82	10000	1/10	A	2	37710	0043168377102
F9BX/840/4P	9	2G7	152,8	600	4000	82	10000	1/10	A	2	37711	0043168377119
F11BX/827/4P	11	2G7	222,8	900	2700	82	10000	1/10	A	2	37717	0043168377171
F11BX/840/4P	11	2G7	222,8	900	4000	82	10000	1/10	A	2	37713	0043168377133

Biax™ L

F18BX/827	18	2G11	228	1250	2700	82	10000	1/25	-	3	30639	5021731306396
F18BX/830	18	2G11	228	1250	3000	82	10000	1/25	-	3	29223	5021731292231
F18BX/835	18	2G11	228	1250	3500	82	10000	1/25	-	3	30613	5021731306136
F18BX/840	18	2G11	228	1250	4000	82	10000	1/25	-	3	30614	5021731306143
F24BX/827	24	2G11	323,4	1800	2700	82	10000	1/25	-	3	30640	5021731306402
F24BX/830	24	2G11	323,4	1800	3000	82	10000	1/25	-	3	30615	5021731306150
F24BX/835	24	2G11	323,4	1800	3500	82	10000	1/25	-	3	29383	5021731293832
F24BX/840	24	2G11	323,4	1800	4000	82	10000	1/25	-	3	29496	5021731294969
F34BX/830*	34	2G11	535	2800	3000	82	10000	1/25	-	3	30682	5021731306822
F34BX/835*	34	2G11	535	2800	3500	82	10000	1/25	-	3	30683	5021731306839
F34BX/840*	34	2G11	535	2800	4000	82	10000	1/25	-	3	30684	5021731306846
F36BX/827	36	2G11	418,4	2900	2700	82	10000	1/25	-	3	30641	5021731306419
F36BX/830	36	2G11	418,4	2900	3000	82	10000	1/25	-	3	29743	5021731297434
F36BX/835	36	2G11	418,4	2900	3500	82	10000	1/25	-	3	29744	5021731297441
F36BX/840	36	2G11	418,4	2900	4000	82	10000	1/25	-	3	29745	5021731297458
F40MBX/830	40	2G11	570,8	3500**	3000	82	10000	1/25	-	3	30028	-
F40MBX/835	40	2G11	570,8	3500**	3500	82	10000	1/25	-	3	30029	5021731300295
F40MBX/840	40	2G11	570,8	3500**	4000	82	10000	1/25	-	3	30030	5021731300301
F55BX/830***	55	2G11	570,8	4850	3000	82	12000	1/25	-	3	31951	5021731319518
F55BX/835***	55	2G11	570,8	4850	3500	82	12000	1/25	-	3	31952	5021731319525
F55BX/840***	55	2G11	570,8	4850	4000	82	12000	1/25	-	3	31953	5021731319532

* Hagymányos előtétellel és elektronikus gyújtóval, vagy elektronikus előtétellel. ** Hagymányos előtétellel 3360 lm. *** Nagyfrekvenciás elektronikus előtétélrel üzemeltetendő.

* Použití s indukčním předradníkem a elektronickým startérem nebo plně elektronickým předradníkem. ** Při provozu s indukčním předradníkem je světelný tok: 3360 lm. *** Provozovatelné na vysokofrekvenčních předradnicích.

* Pouižtie s indukčným predradníkom a elektronickým zapalovačom alebo plne elektronickým predradníkom. ** Pri prevádzke s indukčným predradníkom svetelný tok je: 3360 lm. *** Prevádzkovateľné z vysokofrekvenčných predradníkov.

* Funcționează cu balast convențional și starter electronic sau cu ambele componente electronice. ** Cu circuite convenționale: 3360 lm. *** Se folosește numai cu balast HF.

* Upotreba sa standardnim balastom i elektronskim starterom ili potpuno elektronskom jedinicom. ** Sa klasičnim balastom: 3360 lm. *** Za upotrebu sa visokofrekventnim elektronskim balastom.

* Да се употребува со стандарден баласт и електронски starter или целосно со електронска единица. ** Со класичен баласт: 3360 lm. *** Да се употребува со високофреквентен електронски баласт.

* Да се употребува со обичовен дросел и електронен starter, или с напълно електронно ПРА. ** При обичайната схема на захранване потока е равен на 3360 lm. *** За употреба з високочестотен електронен баласт.

* Kasutamiseks elektromagneetilise ballasti ja elektroonilise starteriga või elektroonilise süüteseadmega. ** Elektromagneetilise süüteseadme kasutamisel on valgusvoog 3360 lm. *** Kasutamiseks elektroonilise süüteseadmega.

* Eksploatacijai ar parastajām drošēlēm un elektroniskajiem starteriem vai ar pilnībā elektronisku palaihdzējkārtu. ** Lietojot parastās iekārtas: 3360 lm. *** Eksploatacijai ar augstas frekvences elektroniskajām drošēlēm.

* Naudoti su įprastiniu balastu ir elektroniniu starteriu arba elektroniniu paleidimo bloku. ** Įprastinė grandinė su įprastiniu balastu. *** Naudoti tik elektronini balasta.

Négycsöves kompakt fénycsövek
Čtyřtrubicové kompaktní zářivky
Štvortrubicové kompaktné žiarivky

Lāmpi fluorescente compacte cu patru tuburi
Četvorocevnne kompakt fluorescentne sijalice
Четвороцевни компакт флуоресцентни сијалици
Четиристволни компактни луминисцентни лампи

Nelja toruga kompaktluminescentslambid
Četru cauruju kompaktās fluorescences spuldzes
Keturių vamzdelių kompaktiškos fluorescencinės lempos

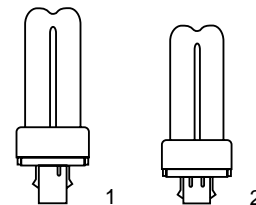

Type	W		L _{max.}	Im	CCT	Ra	t _(h)		Fig.	SKU	EAN
------	---	--	-------------------	----	-----	----	------------------	--	------	-----	-----

FD-D

FD-D10 F82	10	G24d-1	108,5	600	2700	82	10000	1/10	1	170215	9004100702117
FD-D10 F83	10	G24d-1	108,5	600	3000	82	10000	1/10	1	170240	9004100702414
FD-D10 F84	10	G24d-1	108,5	600	4000	82	10000	1/10	1	189852	9004100898513
FD-D10 F865	10	G24d-1	108,5	600	6500	82	10000	1/10	1	195600	9004100956015
FD-D13 F82	13	G24d-1	133	900	2700	82	10000	1/10	1	170223	9004100702230
FD-D13 F83	13	G24d-1	133	900	3000	82	10000	1/10	1	170250	9004100702513
FD-D13 F84	13	G24d-1	133	900	4000	82	10000	1/10	1	189862	9004100898612
FD-D13 F865	13	G24d-1	133	900	6500	82	10000	1/10	1	195630	9004100956312
FD-D18 F82	18	G24d-2	154	1200	2700	82	10000	1/10	1	170233	9004100702339
FD-D18 F83	18	G24d-2	154	1200	3000	82	10000	1/10	1	170263	9004100702612
FD-D18 F84	18	G24d-2	154	1200	4000	82	10000	1/10	1	189873	9004100898711
FD-D18 F865	18	G24d-2	154	1200	6500	82	10000	1/10	1	195680	9004100956817
FD-D26 F82	26	G24d-3	169,5	1710	2700	82	10000	1/10	1	190373	9004100903712
FD-D26 F83	26	G24d-3	169,5	1710	3000	82	10000	1/10	1	170272	9004100702711
FD-D26 F84	26	G24d-3	169,5	1710	4000	82	10000	1/10	1	189883	9004100898810
FD-D26 F865	26	G24d-3	169,5	1710	6500	82	10000	1/10	1	195662	9004100956619

Biax™ D/E

F10DBX/827/4P	10	G24q-1	101	600	2700	82	12000	1/10	2	30031	0043168982689
F10DBX/830/4P	10	G24q-1	101	600	3000	82	12000	1/10	2	12877	0043168128773
F10DBX/835/4P	10	G24q-1	101	600	3500	82	12000	1/10	2	30032	0043168982696
F10DBX/840/4P	10	G24q-1	101	600	4000	82	12000	1/10	2	30034	0043168982702
F13DBX/827/4P	13	G24q-1	125,5	900	2700	82	12000	1/10	2	30035	0043168982719
F13DBX/830/4P	13	G24q-1	125,5	900	3000	82	12000	1/10	2	10580	0043168105804
F13DBX/835/4P	13	G24q-1	125,5	900	3500	82	12000	1/10	2	30037	0043168982726
F13DBX/840/4P	13	G24q-1	125,5	900	4000	82	12000	1/10	2	30038	0043168982733
F18DBX/827/4P	18	G24q-2	146,5	1200	2700	82	12000	1/10	2	12865	0043168128650
F18DBX/830/4P	18	G24q-2	146,5	1200	3000	82	12000	1/10	2	12866	0043168128667
F18DBX/835/4P	18	G24q-2	146,5	1200	3500	82	12000	1/10	2	12869	0043168128698
F18DBX/840/4P	18	G24q-2	146,5	1200	4000	82	12000	1/10	2	12870	0043168128704
F26DBX/827/4P	26	G24q-3	162	1710	2700	82	12000	1/10	2	35247	0043168352475
F26DBX/830/4P	26	G24q-3	162	1710	3000	82	12000	1/10	2	35235	0043168352352
F26DBX/835/4P	26	G24q-3	162	1710	3500	82	12000	1/10	2	35248	0043168352482
F26DBX/840/4P	26	G24q-3	162	1710	4000	82	12000	1/10	2	35236	0043168352369

Hatsöves kompakt fénycsövek
 Šestitubicové kompaktní zářivky
 Šestitubicové kompaktné žiarivky

Lămpi fluorescente compacte cu șase tuburi
 Šestocevne kompakt fluorescentne sijalice
 Шестоцевни компакт флуоресцентни сijaлици
 Шестстволни компактни луминисцентни лампи

Kuue toruga kompaktluminestsenslambid
 Sešu cauruju kompaktais fluorescences spuldzes
 Šešių vamzdelių kompaktiškos fluorescencinės lempos

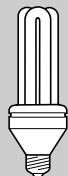
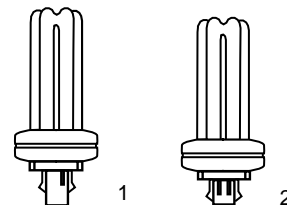

Type	W		L _{max.}	lm	CCT	Ra	t _(h)		Fig.	SKU	EAN
------	---	--	-------------------	----	-----	----	------------------	--	------	-----	-----

Biax™ T

F13TBX/827	13	GX24d-1	115,5	900	2700	82	10000	1/10	1	35940	0043168359405
F13TBX/830	13	GX24d-1	115,5	900	3000	82	10000	1/10	1	35966	0043168359665
F13TBX/835	13	GX24d-1	115,5	900	3500	82	10000	1/10	1	35943	0043168359436
F13TBX/840	13	GX24d-1	115,5	900	4000	82	10000	1/10	1	35941	0043168359412
F13TBX/865	13	GX24d-1	115,5	900	6500	82	10000	1/10	1	35949	0043168359498
F18TBX/827	18	GX24d-2	130	1200	2700	82	10000	1/10	1	35945	0043168359450
F18TBX/830	18	GX24d-2	130	1200	3000	82	10000	1/10	1	35944	0043168359443
F18TBX/835	18	GX24d-2	130	1200	3500	82	10000	1/10	1	35937	0043168359375
F18TBX/840	18	GX24d-2	130	1200	4000	82	10000	1/10	1	35939	0043168359399
F18TBX/865	18	GX24d-2	130	1200	6500	82	10000	1/10	1	35938	0043168359382
F26TBX/827	26	GX24d-3	140	1710	2700	82	10000	1/10	1	35959	0043168359597
F26TBX/830	26	GX24d-3	140	1710	3000	82	10000	1/10	1	35952	0043168359528
F26TBX/835	26	GX24d-3	140	1710	3500	82	10000	1/10	1	35963	0043168359636
F26TBX/840	26	GX24d-3	140	1710	4000	82	10000	1/10	1	35964	0043168359641
F26TBX/865	26	GX24d-3	140	1710	6500	82	10000	1/10	1	35965	0043168359658

Biax™ T/E

F13TBX/827/A/4P	13	GX24q-1	108	900	2700	82	12000	1/10	2	34391	0043168343916
F13TBX/830/A/4P	13	GX24q-1	108	900	3000	82	12000	1/10	2	34395	0043168343954
F13TBX/835/A/4P	13	GX24q-1	108	900	3500	82	12000	1/10	2	34400	0043168344005
F13TBX/840/A/4P	13	GX24q-1	108	900	4000	82	12000	1/10	2	34387	0043168343879
F18TBX/827/A/4P	18	GX24q-2	122,5	1200	2700	82	12000	1/10	2	34392	0043168343923
F18TBX/830/A/4P	18	GX24q-2	122,5	1200	3000	82	12000	1/10	2	34396	0043168343961
F18TBX/835/A/4P	18	GX24q-2	122,5	1200	3500	82	12000	1/10	2	34405	0043168344050
F18TBX/840/A/4P	18	GX24q-2	122,5	1200	4000	82	12000	1/10	2	34385	0043168343855
F26TBX/827/A/4P	26	GX24q-3	132,5	1710	2700	82	12000	1/10	2	34393	0043168343930
F26TBX/830/A/4P	26	GX24q-3	132,5	1710	3000	82	12000	1/10	2	34397	0043168343978
F26TBX/835/A/4P	26	GX24q-3	132,5	1710	3500	82	12000	1/10	2	34406	0043168344067
F26TBX/840/A/4P	26	GX24q-3	132,5	1710	4000	82	12000	1/10	2	34381	0043168343817
F32TBX/827/4P	32	GX24q-3	140,5	2200	2700	82	12000	1/10	2	39377	0043168393775
F32TBX/830/4P	32	GX24q-3	140,5	2200	3000	82	12000	1/10	2	39378	0043168393782
F32TBX/835/4P	32	GX24q-3	140,5	2200	3500	82	12000	1/10	2	39379	0043168393799
F32TBX/840/4P	32	GX24q-3	140,5	2200	4000	82	12000	1/10	2	39380	0043168393805
F42TBX/827/A/4P/EOL	42	GX24q-4	162,5	3200	2700	82	12000	1/10	2	46312	0043168463126
F42TBX/830/A/4P/EOL	42	GX24q-4	162,5	3200	3000	82	12000	1/10	2	46313	0043168463133
F42TBX/835/A/4P/EOL	42	GX24q-4	162,5	3200	3500	82	12000	1/10	2	46314	0043168463140
F42TBX/840/A/4P/EOL	42	GX24q-4	162,5	3200	4000	82	12000	1/10	2	46315	0043168463157

BIAX™ 2D kompakt fénycsövek

Kompaktní zářivky BIAX™ 2D

Kompakné žiarivky BIAX™ 2D

Lämpí fluorescente compacte BIAX™ 2D

BIAX™ 2D kompakt fluorescentne sijalice

BIAX™ 2D компакт флуоресцентни сијалици

BIAX™ 2D компактни луминисцентни лампи

BIAX™ 2D kompaktluminescentslambid

BIAX™ 2D kompaktās fluorescences spuldzes

BIAX™ 2D kompaktiškos fluorescencinēs lempas

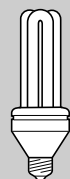
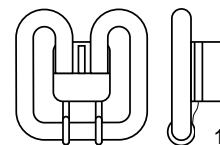

Type	W		L _{max.}	lm	CCT	Ra	t _(h)		Fig.	SKU	EAN
------	---	--	-------------------	----	-----	----	------------------	--	------	-----	-----

Biax™ 2D

F162D/827	16	GR8	142	1050	2700	82	10000	1/20	1	32416	0043168324168
F162D/835	16	GR8	142	1050	3500	82	10000	1/20	1	32419	5021731324192
F162D/860	16	GR8	142	1050	6000	82	10000	1/20	1	32454	5021731324543
F282D/827	28	GR8	204	2050	2700	82	10000	1/20	1	34515	0043168345156



Biax™ 2D/E

F102D/827/4P	10	GR10q	92	650	2700	82	10000	1/5	1	29433	5021731294334
F102D/835/4P	10	GR10q	92	650	3500	82	10000	1/5	1	28366	5021731283666
F162D/827/4P	16	GR10q	142	1050	2700	82	10000	1/20	1	32422	0043168324229
F162D/835/4P	16	GR10q	142	1050	3500	82	10000	1/20	1	32425	5021731324253
F212D/827/4P	21	GR10q	142	1350	2700	82	10000	1/20	1	32430	0043168324304
F212D/835/4P	21	GR10q	142	1350	3500	82	10000	1/20	1	32431	-
F212D/860/4P	21	GR10q	142	1350	6000	82	10000	1/20	1	32453	5021731324536
F282D/827/4P	28	GR10q	204	2050	2700	82	10000	1/20	1	34546	0043168345460
F282D/835/4P	28	GR10q	204	2050	3500	82	10000	1/20	1	34550	0043168345507
F282D/840/4P	28	GR10q	204	2050	4000	82	10000	1/20	1	37510	0043168375108
F382D/827/4P	38	GR10q	204	2850	2700	82	10000	1/20	1	34544	0043168345446
F382D/835/4P	38	GR10q	204	2850	3500	82	10000	1/20	1	34549	0043168345491
F552D/827/4P	55	GRY10q-3	204	3900	2700	82	10000	1/20	1	37523	0043168375238
F552D/835/4P	55	GRY10q-3	204	3900	3500	82	10000	1/20	1	37528	0043168375283



Biax™ 2D

beépített előtéttel ● se zabudovaným zapalovačem ● so zabudovaným zapalovačom

cu starter încorporat ● sa internim starterom ● со вграден стартер ● с вграден стартер

sisemise starteriga ● ar iekšēju starteri ● su vidiniu starteriu

FLE18W2D/827/GR10	18	GRZ 10d	137	1150	2700	82	10000	126	1	92593	-
FLE18W2D/830/GR10	18	GRZ 10d	137	1150	2700	82	10000	126	1	92592	-
FLE18W2D/835/GR10	18	GRZ 10d	137	1150	2700	82	10000	126	1	92594	-
FLE18W2D/840/GR10	18	GRZ 10d	137	1150	2700	82	10000	126	1	92595	-
FLE30W2D/827/GR10	30	GRZ 10t	137	2050	2700	82	10000	48	1	92596	-
FLE30W2D/830/GR10	30	GRZ 10t	137	2050	2700	82	10000	48	1	92597	-
FLE30W2D/835/GR10	30	GRZ 10t	137	2050	2700	82	10000	48	1	92598	-
FLE30W2D/840/GR10	30	GRZ 10t	137	2050	2700	82	10000	48	1	92599	-

Elektronikus előtétellel egybeépített kompakt fénycsővek
Elektronické kompaktní zářivky se zabudovaným předřadníkem
Elektronické kompaktné žiarivky so zabudovaným predradníkom

Lámpa fluorescente compacte cu elemente adiționale electronice
Kompakt fluorescentne sijalice sa ugradjenim elektronskim balastom
Компакт флуоресцентни сијалици со вграден електронски баласт
Компактни луминисцентни лампи с вграден електронен баласт

Elektroonilise süüteseadmega kompaktluminescentslambid
Kompaktās fluorescences spuldzes ar cokolā iemontētu elektronisko drošeli
Kompaktiškos fluorescencinēs lempos su įmontuotu elektroniniu drošeliu

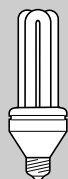
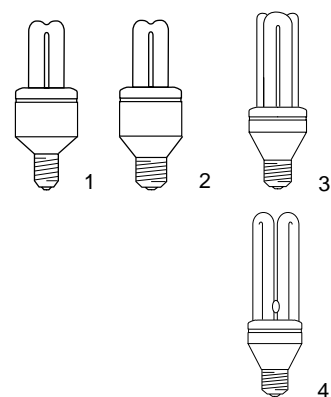

Type	W	V		L _{max.}	Im	CCT	Ra	t _(h)		EEC	Fig.	SKU	EAN
------	---	---	--	-------------------	----	-----	----	------------------	--	-----	------	-----	-----

12,000 h

E4 9W/U	F82	9	220/240	E14	125	480	2700	82	12000	1/6	A	1	511570	5994100098737
E4 11W/U	F82	11	220/240	E14	129,5	600	2700	82	12000	1/6	A	1	511568	5994100098751
E4 9W/U	F82	9	220/240	E27	125	480	2700	82	12000	1/6	A	2	511569	5994100098744
E4 11W/U	F82	11	230/240	E27	129,5	600	2700	82	12000	1/6	A	2	511567	5994100098768
E6/L 15W	F82	15	230/240	E27	135,5	900	2700	82	12000	1/6	A	3	507958	5994100079583
	F84	15	230/240	E27	135,5	900	4000	82	12000	1/6	A	3	507961	5994100079613
	F86	15	230/240	E27	135,5	900	6500	82	12000	1/6	A	3	509887	5994100098874
E6/L 20W	F82	20	230/240	E27	150	1200	2700	82	12000	1/6	A	3	507956	5994100079569
	F84	20	230/240	E27	150	1200	4000	82	12000	1/6	A	3	507962	5994100079620
	F86	20	230/240	E27	150	1200	6500	82	12000	1/6	A	3	509886	5994100098867
E8 23W	F82	23	230/240	E27	146	1500	2700	82	12000	1/6	A	4	509878	5994100098782
	F84	23	230/240	E27	146	1500	4000	82	12000	1/6	A	4	509882	5994100098829
	F86	23	220/240	E27	146	1500	6500	82	12000	1/6	A	4	509888	5994100098881

8,000 h

E4 9W/UQ	F82	9	220/240	E14	125	480	2700	80	8000	1/10	A	1	511846	5994100118466
	F86	9	220/240	E14	125	480	6500	80	8000	1/10	A	1	511856	5994100118565
E4 9W/UQ	F82	9	220/240	E27	125	480	2700	80	8000	1/10	A	2	511845	5994100118459
E4 11W/UQ	F82	11	230/240	E27	129,5	600	2700	80	8000	1/10	A	2	511862	5994100118626
E6 15W/LQ	F82	15	230/240	E27	137,5	900	2700	80	8000	1/10	A	3	511849	5994100118497
	F86	15	230/240	E27	137,5	900	6500	80	8000	1/10	A	3	511858	5994100118589
E6 20W/LQ	F82	20	230/240	E27	152	1200	2700	80	8000	1/10	A	3	511851	5994100118510
	F86	20	230/240	E27	152	1200	6500	80	8000	1/10	A	3	511857	5994100118572
E6 23W/AQ	F82	23	230/240	E27	162,5	1500	2700	80	8000	1/10	A	3	511853	5994100118534
	F86	23	230/240	E27	162,5	1500	6500	80	8000	1/10	A	3	511864	5994100118640

Start 5,000 h

E4 9W/UQ	F82	9	220/240	E14	135	480	2700	80	5000	1/10	A	1	512777	5994100127772
	F84	9	220/240	E14	135	480	4000	80	5000	1/10	A	1	512782	5994100127826
E4 11W/UQ	F82	11	220/240	E14	139,5	600	2700	80	5000	1/10	A	1	512781	5994100127819
	F84	11	220/240	E14	139,5	600	4000	80	5000	1/10	A	1	512784	5994100127840
E4 9W/UQ	F82	9	220/240	E27	132,5	480	2700	80	5000	1/10	A	2	512778	5994100127789
	F84	9	220/240	E27	132,5	480	4000	80	5000	1/10	A	2	512779	5994100127796
E4 11W/UQ	F82	11	220/240	E27	137	600	2700	80	5000	1/10	A	2	512780	5994100127802
	F84	11	220/240	E27	137	600	4000	80	5000	1/10	A	2	512783	5994100127833
E6 15W/LQ	F82	15	220/240	E27	138	900	2700	80	5000	1/10	A	3	512785	5994100127857
	F84	15	220/240	E27	138	900	4000	80	5000	1/10	A	3	512790	5994100127901
	F865	15	220/240	E27	138	900	6500	80	5000	1/10	A	3	512796	5994100127963
E6 20W/LQ	F82	15	220/240	E27	152,5	1200	2700	80	5000	1/10	A	3	512787	5994100127871
	F84	15	220/240	E27	152,5	1200	4000	80	5000	1/10	A	3	512794	5994100127949
	F865	15	220/240	E27	152,5	1200	6500	80	5000	1/10	A	3	512798	5994100127987

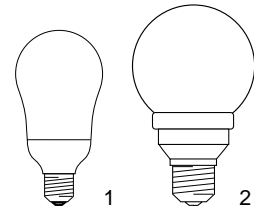

Type	W	V		L _{max.}	Im	CCT	Ra	t _(h)		EEC	Fig.	SKU	EAN
------	---	---	--	-------------------	----	-----	----	------------------	--	-----	------	-----	-----

Electronic Biax™ Elegance GLS

FLE15TBX/GLS/827 E27	15	230/240	E27	144	750	2700	79	6000	1/6	B	1	92225	0043168377225
FLE20TBX/GLS/827 E27	20	230/240	E27	158	1080	2700	79	6000	1/6	B	1	92229	0043168377263



Electronic Biax™ Elegance Globe

ø 80 mm

FLE11DBX/U//GG/827 E27 11 220/240 E27 139 450 2700 82 12000 1/6 B 2 92221 0043168366106

ø 92 mm

E6/15G-92 F82 15 220/240 E27 152 750 2700 82 12000 1/6 B 2 507959 5994100079590

ø 118 mm

E6/20G-118 F82 20 220/240 E27 180 1050 2700 82 12000 1/6 B 2 507957 5994100079576

FLE23QBX//A/GG/827 E27 23 220/240 E27 181 1250 2700 82 12000 1/6 B 2 92190 0043168364171

GENURA™ R80

indukciós lámpa ● indukční zářivky ● indukčná žiarivka

lāmpi cu inducție ● indukzione sijalice ● индукциони сијалици ● индукционни лампи

induktsioonlamp ● indukcijas spuldzes ● indukcinės lempos

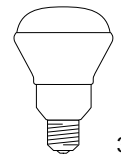

3

ø 82 mm

EFL/23W/827 R80 23 220/240 E27 129,2 1100 2700 82 15000 1/6 A 3 92244 0043168366182

EFL/23W/830 R80 23 220/240 E27 129,2 1100 3000 82 15000 1/6 A 3 92246 0043168366243

Kerámia kisülőcsöves fémhalogénlámpák
Halogenidové výbojky s keramickým hořákem
Halogenidové výbojky s keramickým horákom

Lāmpi metal-halogene cu tub de descărcare ceramic
Cevaste Metal Halogene sijalice sa keramičkim lukom
Керамички метал халогени сијалици
Керамични металохалогенни лампи

Keraamilised metallhalogeniidlambid
Nemainigas krāsas keramikas metālhalogenidspuldzes
Metalu halogenidų lempos su keraminiu išlydžio vamzdeliu

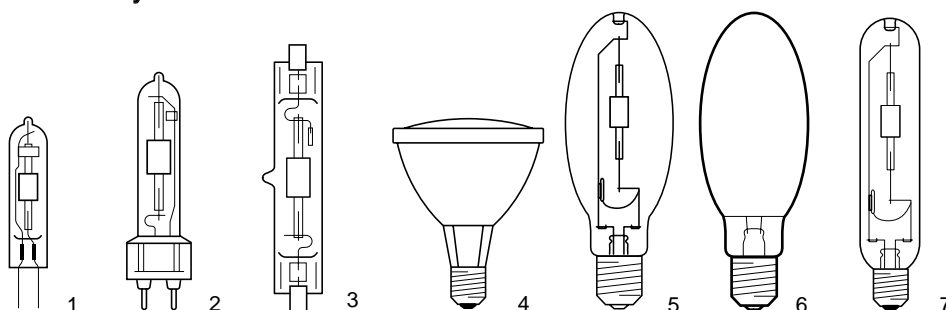
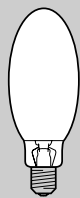

Type	W		L _{max.}	lm	CCT	Ra	t _(h)		Fig.	SKU	EAN
------	---	--	-------------------	----	-----	----	------------------	--	------	-----	-----

ConstantColor™ CMH



vilāgos ● čirá ● číra ● clar ● bistra ● просвірна ● прозрачна ● klaar ● caurspīdīga ● skaidrus

CMH20/TC/UVC/U/830/G8.5	20	G8.5	81	1650	3000	80+	6000	1/12	1	92079	0043168920797
CMH35/TC/UVC/U/830/G8.5	35	G8.5	81	3400	3000	80+	9000	1/12	1	38697	0043168386975
CMH70/TC/UVC/U/830/G8.5	70	G8.5	81	6200	3000	80+	9000	1/12	1	38700	0043168387002
CMH35/T/UVC/U/830/G12	35	G12	76	3400	3000	80+	9000	1/12	2	38696	0043168386968
CMH70/T/UVC/U/830/G12	70	G12	88	6400	3000	80+	12000	1/12	2	36844	0043168368445
CMH70/T/UVC/U/942/G12	70	G12	88	6000	4200	90+	12000	1/12	2	38701	0043168387019
CMH150/T/UVC/U/830/G12	150	G12	98	14000	3000	80+	12000	1/12	2	36863	0043168368636
CMH150/T/UVC/U/942/G12	150	G12	98	12000	4200	90+	12000	1/12	2	38694	0043168386944
CMH70/TD/UVC/830/Rx7s	70	Rx7s	118	7000	3000	80+	15000	1/12	3	36910	0043168369107
CMH70/TD/UVC/942/Rx7s	70	Rx7s	118	6200	4200	90+	15000	1/12	3	38698	0043168386982
CMH150/TD/UVC/830/Rx7s-24	150	Rx7s-24	135	14500	3000	80+	15000	1/12	3	36912	0043168369121
CMH150/TD/UVC/942/Rx7s-24	150	Rx7s-24	135	12500	4200	90+	15000	1/12	3	38692	0043168386920
CMH35/PAR20/UVC/830/E27/SP	35	E27	81,2	2100	3000	80+	9000	1/6	4	41883	0043168418836
CMH35/PAR20/UVC/830/E27/FL	35	E27	81,2	2100	3000	80+	9000	1/6	4	41884	0043168418843
CMH35/PAR30/UVC/830/E27/SP	35	E27	120	2400	3000	80+	9000	1/6	4	41886	0043168418867
CMH70/PAR30/UVC/830/E27/SP	70	E27	120	4700	3000	80+	9000	1/6	4	41621	0043168416214
CMH35/PAR30/UVC/830/E27/FL	35	E27	120	2400	3000	80+	9000	1/6	4	41887	0043168418874
CMH70/PAR30/UVC/830/E27/FL	70	E27	120	4700	3000	80+	9000	1/6	4	41620	0043168416207
CMH70/E/UVC/U/830/E27/C	70	E27	138	6300	3000	80+	10000	1/12	5	46189	0043168461894
CMH100/E/UVC/U/830/E27/C	100	E27	138	9200	3000	80+	10000	1/12	5	46191	0043168461917
CMH70/E/UVC/U/830/E27/D	70	E27	138	6300	3000	80+	10000	1/12	6	46187	0043168461870
CMH70/E/UVC/U/830/E27/D	100	E27	138	8200	3000	80+	10000	1/12	6	46194	0043168461948
CMH70/T/UVC/830/E27	70	E27	154	6400	3000	80+	12000	1/6	7	38752	0043168387521
CMH150/T/UVC/830/E40	150	E40	209	14000	3000	80+	12000	1/6	7	38749	0043168387491



Nappali fényű fémhalogénlámpák

Halogenidové výbojky s denním světlem

Halogenidové výbojky s denným svetlom

Lāmpī metal-halogene de luminā naturalā

Metal halogene sijalice sa dnevni svetlom

Метал халогени сијалици со дневна светлина

Металхалогени лампи с дневна светлина

Päevavalguse metallhalogeniidlampid

Dienasgaismas metālhalogenidspuldzes

Metalu halogenidu dienos šviesos lempos

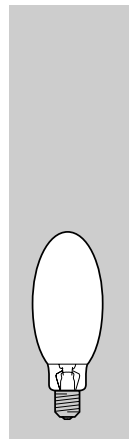
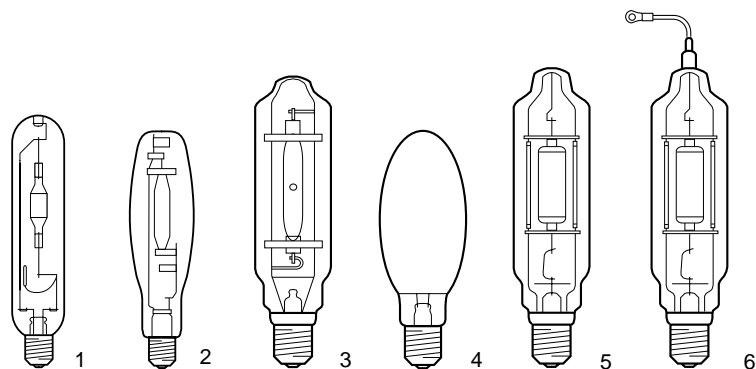

Type	W		L _{max.}	Ø	LCL	Im	CCT	Ra	t _(h)	Fig.	SKU	EAN
------	---	--	-------------------	---	-----	----	-----	----	------------------	------	-----	-----

230 V

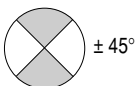

világos ● čirá ● čira ● clar ● bistra ● просирна ● прозрочна ● klaar ● caurspidīga ● skaidrus													
HgMI 250W/DH	250	E40	220	52	150	19000	6000	>90	10000	1/12	1	177890	9004100778914
HgMIF 400W/DH	370	E40	270	59	175	25000	6000	>90	10000	1/12	2	178074	9004100780719

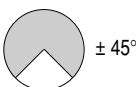

világos ● čirá ● čira ● clar ● bistra ● просирна ● прозрочна ● klaar ● caurspidīga ● skaidrus													
HgMI 250W/DV	250	E40	220	52	150	20500	6000	>90	10000	1/12	1	178380	9004100783819
HgMIF 400W/DV	370	E40	270	59	175	28000	6000	>90	10000	1/12	2	178094	9004100780917

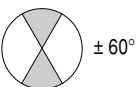

világos ● čirá ● čira ● clar ● bistra ● просирна ● прозрочна ● klaar ● caurspidīga ● skaidrus													
HgMI 1000W/D1	1000	E40	340	80	205	80000	6000	>90	8000	1/6	3	178515	9004100785110

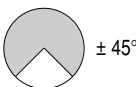

diffúz ● difuzni ● difúzna ● opal ● difuzni ● дифузен ● дифузен ● matt ● difúza ● difuzinis													
HgMIL 250W/DV	250	E40	227	90	-	17000	6000	>90	10000	1/12	4	178480	9004100784816
HgMIL 400W/DV	370	E40	292	120	-	26000	6000	>90	10000	1/4	4	178057	9004100780511

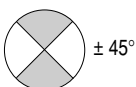

diffúz ● difuzni ● difúzna ● opal ● difuzni ● дифузен ● дифузен ● matt ● difúza ● difuzinis													
HgMIL 250W/DH	250	E40	227	90	-	17000	6000	>90	10000	1/12	4	177910	9004100779119
HgMIL 400W/DH	370	E40	292	120	-	24000	6000	>90	10000	1/4	4	178034	9004100780313

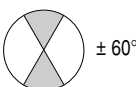

diffúz ● difuzni ● difúzna ● opal ● difuzni ● дифузен ● дифузен ● matt ● difúza ● difuzinis													
HgMIL 1000W/D	1000	E40	380	160	-	68000	6000	>90	8000	1/4	4	178534	9004100785318

400 V

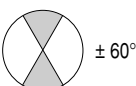

világos ● čirá ● čira ● clar ● bistra ● просирна ● прозрочна ● klaar ● caurspidīga ● skaidrus													
HgMI 2000W/D1	2000	E40	430	101	260	170000	6000	>90	5000	1/4	5	178615	9004100786117
HgMIG 2000W/D	2000	E40	430	101	260	170000	6000	>90	5000	1/4	5	178653	9004100786513
HgMI 3500W/D1	3500	E40	430	101	260	300000	6000	>90	500	1/4	5	178665	9004100786612
HgMI 2000W/D2	2000	E40	490	101	260	170000	6000	>90	5000	1/4	6	178623	9004100786216
HgMI 3500W/D2	3500	E40	490	101	260	300000	6000	>90	500	1/4	6	178683	9004100786810

D1: megfelelő leghűsítő idő után gyújtathó újra. D2: azonnal újragyújtathó. G: gyújtókészülék nélkül használandó.
 D1: opětovné zapálení po uplynutí doby chlazení. D2: okamžitě znovu zapalovatelné. G: použití zapalovače zakázané.
 D1: znovuzapálenie po uplynutí doby chladnutia. D2: okamžite znovuzapáliteľné. G: použitie zapalovača zakázané.
 D1: poate fi rearmată după perioadă de răcire. D2: poate fi rearmată imediat. G: utilizarea dispozitivului de amorsare este interzisă.
 D1: ponovno paljenje posle perioda hladjenja D2: momentalno ponovno paljenje G: isključivo za upotrebu bez uredjaja za startovanje
 D1: повторно палење по времето за ладење. D2: моментално повторно палење. G: исклучиво за употреба без стартер.
 D1: повторно запалване след периода на охлаждане. D2: моментално запалване отново. G: за употреба без запално устрйство.
 D1: võib uuesti sisselülitada pärast jahtumist. D2: võib kohe uuesti sisselülitada. G: rangelt kasutamiseks ilma starterita.
 D1: var atsākt darbību pēc atdzišanas perioda. D2: var atsākt darbību nekavējoties. G: tikai lietošanai kopā ar palaišanas ierīci.
 D1: galima vėl įjungti, kai atvėsta D2: galima įjungti nelaukiant. G: naudoti tik be paleidimo įtaiso.

Természetes fehér fényű fémhalogénlámpák
Halogenidové výbojky s přirozeným bílým světlem
Halogenidové výbojky s prirodzeným bielym svetlom

Lämpö metal-halogene de lumină albă
Neutralno bele metal halogene sijalice
Неутрално бели метал халогени сијалици
Неутрално бели металохалогенни лампи

Valge valguse metallhalogeniidlambid
Dabigi baltas metālhalogenīdspuldzes
Naturalios baltos šviesos metalų halogenidų lempos

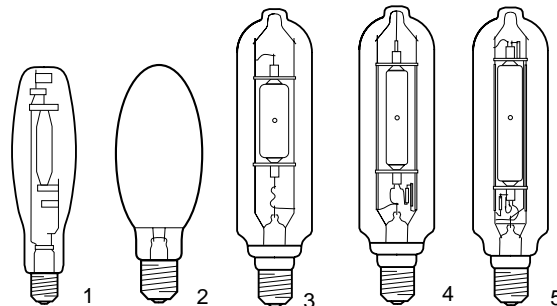

Type	W		L _{max.}	Ø	LCL	Im	CCT	Ra	t _(h)	Fig.	SKU	EAN
------	---	--	-------------------	---	-----	----	-----	----	------------------	------	-----	-----

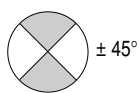

világos ● čirá ● číra ● clar ● bistra ● прозира ● прозрачна ● klaar ● caurspidīga ● skaidrus												
HgMIF 400W	390	E40	270	59	175	30000	4000	65	10000	1/12	1	178364 9004100783611
diffúz ● difuzní ● difúzna ● opal ● difuzni ● дифузен ● дифузен ● matt ● difúza ● difuzinis												
HgMIL 400W	390	E40	292	120	-	27000	4000	65	10000	1/4	2	178114 9004100781112

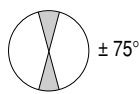

világos ● čirá ● číra ● clar ● bistra ● прозира ● прозрачна ● klaar ● caurspidīga ● skaidrus												
HgMI 2000W/220V	1900	E40	430	101	287	180000	4000	65	2000	1/4	3	178554 9004100785516
HgMI 2000W/380V	2000	E40	430	101	260	190000	4000	65	2000	1/4	4	178584 9004100785813

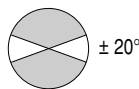

világos ● čirá ● číra ● clar ● bistra ● прозира ● прозрачна ● klaar ● caurspidīga ● skaidrus												
HgMIG 2000W/S	2000	E40	430	101	260	210000	3500	65	3500	1/4	5	178633 9004100786315

G: gyűjtőkészülék nélkül használandó.
 G: použití zapalovače zakázané.
 G: použitie zapalovača zakázané.
 G: utilizarea dispozitivului de amorsare este interzisă.
 G: isključivo za upotrebu bez uređaja za startovanje
 G: исклучиво за употреба без стартер.
 G: за употреба без запално устройство.
 G: rangelt kasutamiseks ilma starterita.
 G: tikai lietošanai kopā ar palaišanas ierīci.
 G: naudoti tik be paleidimo įtaiso.

Két végén fejezt fémhalogénlámpák
Halogenidové výbojky oboustranně patřicované
Halogenidové výbojky obojstranne päticované

Lämpö metal-halogene cu racord la ambele capete
Metal halogene sijalice sa dva podnožja
Двострани метал халогени сијалици
Софитни металохалогенни лампи

Kahe sokliga metallhalogeniidlambid
Divkontakta metālhalogenīdspuldzes
Metalų halogenidų lempos su išvadais abiejuose galuose

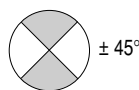
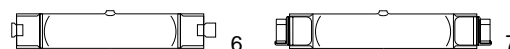

világos ● čirá ● číra ● clar ● bistra ● прозира ● прозрачна ● klaar ● caurspidīga ● skaidrus												
HgMIS70W/WDL	75	R7s	120	20	57	5000	3000	75-80	8000	1/12	6	190382 9004100903811
HgMIS70W/BDL	75	R7s	120	20	57	5500	3500	75-80	8000	1/12	6	178500 9004100785011
HgMIS70W/NDL	75	R7s	120	20	57	5500	4200	75-80	8000	1/12	6	178142 9004100781419
HgMIS150W/WDL	150	R7s	132	24	66	11000	3200	80	8000	1/12	6	178165 9004100781617
HgMIS150W/BDL	150	R7s	132	24	66	12000	3500	75-80	8000	1/12	6	178010 9004100780115
HgMIS150W/NDL	150	R7s	132	24	66	11000	4000	80	8000	1/12	6	178394 9004100783918
HgMIS150W/D	150	R7s	132	24	66	11000	5200	85	8000	1/12	6	178150 9004100781518
HgMIS150W/AQUA	150	R7s	132	24	66	11000	6500	70	8000	1/12	6	190960 9004100909615
HgMIS250W/WDL	250	Fc2	163	25	81,5	20000	3200	80	8000	1/12	7	178374 9004100783710
HgMIS250W/NDL	250	Fc2	163	25	81,5	20000	4300	80	8000	1/12	7	190412 9004100904115

Kompakt fémhalogénlámpák
Kompaktní halogenidové výbojky
Kompaktné halogenidové výbojky

Lámpa metal-halogene compacte
Metal halogene kompakt sijalice
Метал халогени сијалици
Металхалогенни лампи

Kompakt-metallhalogeniidlampid
Kompaktās metāhalogenīdspuldzes
Kompaktiškos metalų halogenidų lempos

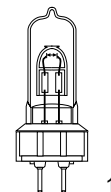

Type	W		L _{max.}	lm	CCT	Ra	t _(h)		Fig.	SKU	EAN
------	---	--	-------------------	----	-----	----	------------------	--	------	-----	-----

Arcstream™

vilāģos ● čirā ● čira ● clar ● bistra ● просирна ● прозрачна ● klaar ● caurspidīga ● skaidrus

ARC70/T/U/730/G12	70	G12	76	5200	3000	75	6000	1/20	1	35794	0043168357944
ARC70/T/U/742/G12	70	G12	76	5200	4200	72	6000	1/20	1	35795	0043168357951
ARC150/T/U/730/G12	150	G12	88	11500	3000	75	6000	1/10	1	21053	0043168210539
ARC150/T/U/742/G12	150	G12	88	12000	4200	72	6000	1/10	1	21054	0043168210546



Ultraibolya lámpák
Výbojky s ultrafialovým světlem
Výbojky s ultrafialovým svetlom

Lámpa UV
UV sijalice
УВ сијалици
UV лампи

UV lampid
UV spuldzes
UV spindulių lempos



2

Type	W	A		L _{max.}	∅	*W		Fig.	SKU	EAN
------	---	---	--	-------------------	---	----	--	------	-----	-----

HgV 125	125	1,15	E27	170	75	2,75 x 10 ⁻³	1/25	2	505523	5994100055235
HMV 160	160	0,75	E27	170	75	1,2 x 10 ⁻³	1/25	2	175454	9004100754512



* Max. kisugárzott energia 365,5 nm-en (W).

* Max. vyzarovaná energie při 365,5 nm (W)

* Max. vyžarovaná energia pri 365,5 nm (W).

* Energie maximā radiat ā 365,5 nm (W).

* Max. emitovana UV na 365,5 nm (W).

* Макс. емитирана UV на 365,5 нм (Ват).

* Макс. излъчвана енергия на 365,5 нм (W).

* Maksimaalne voog 365,5 nm juures (W).

* Maksimāli izstarotais UV starojums pie 365,5 nm.

* Didžiausias spinduliuojamos UV spindulių energijos srautas, kai bangos ilgis 365,5 nm.

Nagynyomású higanygőzlámpák

Vysokotlaké rtuťové výbojky

Vysokotlakové ortuťové výbojky

Lămpi cu mercur de înaltă presiune

Živine sijalice visokog pritiska

Живини сијалици со висок притисок

Живачни лампи с високо налягане

Kőrgsurve elavhőbelambid

Augstspiediena dzivsudraba tvaiku spuldzes

Aukšto slėgio gyvsidabrio garų lempos

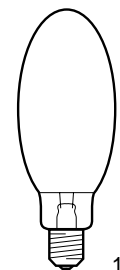

1

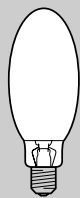

Type	W		L _{max.}	Ø	lm	CCT	Ra	t _(h)		Fig.	SKU	EAN
------	---	--	-------------------	---	----	-----	----	------------------	--	------	-----	-----

lágyűveg ● mēkké sklo ● mäkké sklo ● sticla moale ● meko staklo ● меко стакло ● меко стъкло ● pehme klaas ● miksts stikls ● minkštasis stiklas												
HgLI 50W	50	E27	130	55	1800	4000	40	16000	1/40	1	505504	5994100055044
HgLI 80W	80	E27	156	70	3800	4000	40	20000	1/40	1	505505	5994100055051
HgLI 125W	125	E27	170	75	6300	4000	40	20000	1/25	1	505506	5994100055068

keményűveg ● tvrdé sklo ● tvrdé sklo ● sticla dură ● tvrdo staklo ● тврдо стакло ● твърдо стъкло ● kőva klaas ● ciets stikls ● lydomas stiklas												
HgLI/H 80W	80	E27	156	70	3700	4000	40	20000	1/40	1	505512	5994100055129
HgLI/H 125W	125	E27	170	75	6300	4000	40	20000	1/25	1	505513	5994100055136

keményűveg ● tvrdé sklo ● tvrdé sklo ● sticla dură ● tvrdo staklo ● тврдо стакло ● твърдо стъкло ● kőva klaas ● ciets stikls ● lydomas stiklas												
HgLI 125W	125	E40	170	75	6300	4000	40	20000	1/25	1	505514	5994100055143
HgLI 175W	175	E40	214	90	8100	4000	40	20000	1/12	1	505507	5994100055075
HgLI 250W	250	E40	227	90	13000	4000	40	20000	1/12	1	505508	5994100055082
HgLI 400W	400	E40	292	120	22500	4000	40	20000	1/12	1	505509	5994100055099

DE-LUXE

lágyűveg ● mēkké sklo ● mäkké sklo ● sticla moale ● meko staklo ● меко стакло ● меко стъкло ● pehme klaas ● miksts stikls ● minkštasis stiklas												
HgLI50W de luxe	50	E27	130	55	2000	3500	57	16000	1/40	1	505515	5994100055150
HgLI80W de luxe	80	E27	156	70	4000	3400	57	20000	1/40	1	505516	5994100055167
HgLI125W de luxe	125	E27	170	75	6500	3350	55	20000	1/25	1	505517	5994100055174

keményűveg ● tvrdé sklo ● tvrdé sklo ● sticla dură ● tvrdo staklo ● тврдо стакло ● твърдо стъкло ● kőva klaas ● ciets stikls ● lydomas stiklas												
HgLI /H80W de luxe	80	E27	156	70	4000	3400	57	20000	1/40	1	505521	5994100055211
HgLI/H125W de luxe	125	E27	170	75	6500	3500	55	20000	1/25	1	505522	5994100055228

keményűveg ● tvrdé sklo ● tvrdé sklo ● sticla dură ● tvrdo staklo ● тврдо стакло ● твърдо стъкло ● kőva klaas ● ciets stikls ● lydomas stiklas												
HgLI250W de luxe	250	E40	227	90	14000	3350	55	20000	1/12	1	505518	5994100055181
HgLI400W de luxe	400	E40	292	120	24000	3400	50	20000	1/12	1	505519	5994100055198

Kevertfényű lámpák

Výbojky se smíšeným světlem

Výbojky so zsmiešaným svetlom

Lămpi cu lumină combinată

Sijalice sa mešaním svetlom

Сијалици со мешано светло

Лампи със смесена светлина

Segavalguslambid

Jauktas gaismas spuldzes

Mišraus švytėjimo lempos

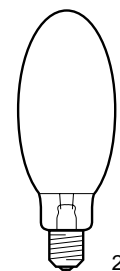

2



± 30°

HMLI 160W	160	E27	180	75	3000	4000	52	10000	1/40	2	85888	0043168858885
-----------	-----	-----	-----	----	------	------	----	-------	------	---	-------	---------------



HMLI 250W	250	E40	227	90	5500	4200	52	10000	1/12	2	85949	0043168859493
ML230-240V 500W E40	500	E40	295	120	14000	3500	52	8000	1/10	2	85904	0043168859042

Nagynyomású nátriumlámpák
Vysokotlaké sodíkové výbojky
Vysokotlakové sodíkové výbojky

Lāmpi cu sodiu la înaltă presiune
Natrijumove sijalice visokog pritiska
Натриумови сијалици со висок притисок
Натриеви лампи с високо налягане

Kõrgsurve naatriumlambid
Augstspiediena nātrija spuldzes
Aukšto slėgio natrio lempos

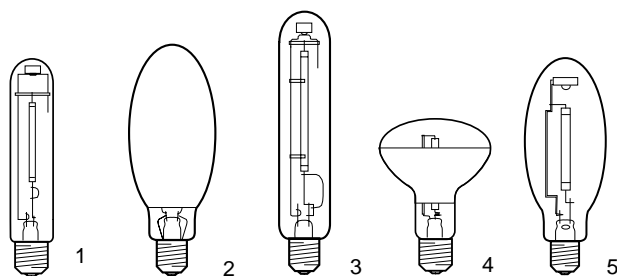

Type	W		L _{max.}	lm	CCT	Ra	t _(h)		Fig.	SKU	EAN
------	---	--	-------------------	----	-----	----	------------------	--	------	-----	-----

Lucalox™ T



vilāgos ● čirā ● čira ● clar ● bistra ● просирна ● прозрачна ● klaar ● caurspīdīga ● skaidrus	W	Base	L _{max.}	lm	CCT	Ra	t _(h)	Fig.	SKU	EAN	
LU50/85/T/27	50	E27	156	3400	2000	25	28500	1/25	1	176260	9004100762616
LU70/90/T12/27	70	E27	156	6000	2000	25	28500	1/25	1	176210	9004100762111
LU100/100/T/40	100	E40	211	49600	2000	25	28500	1/12	1	176490	9004100764917
LU150/100/T/40	150	E40	211	15000	2000	25	28500	1/12	1	176620	9004100766218
LU250/T/40	250	E40	260	27500	2000	25	28500	1/12	1	177210	9004100772110
LU400/T/40	400	E40	283	50000	2000	25	28500	1/12	1	177220	9004100772219
TC 1000W*	1000	E40	372	130000	2000	25	24000	1/4	1	506936	5994100069362



Lucalox™ E



diffúz ● difuzní ● difúzna ● opal ● difuzni ● дифузен ● дифузен ● matt ● difūza ● difuzinis	W	Base	L _{max.}	lm	CCT	Ra	t _(h)	Fig.	SKU	EAN	
LU50/85/D/27	50	E27	156	3300	2000	25	28500	1/12	2	176120	9004100761213
LU70/90/D/27	70	E27	156	5800	2000	25	28500	1/12	2	176110	9004100761114
LU100/100/D/40	100	E40	186	9200	2000	25	28500	1/12	2	176870	9004100768717
LU150/100/D/40	150	E40	227	14500	2000	25	28500	1/12	2	176880	9004100768816
LU250/D/40	250	E40	227	26000	2000	25	28500	1/12	2	177230	9004100772318
LU400/D/40	400	E40	292	47500	2000	25	28500	1/6	2	177240	9004100772417
TCL 1000W*	1000	E40	372	120000	2000	25	24000	1	2	177766	9004100777610



Lucalox™ HO



vilāgos ● čirā ● čira ● clar ● bistra ● просирна ● прозрачна ● klaar ● caurspīdīga ● skaidrus	W	Base	L _{max.}	lm	CCT	Ra	t _(h)	Fig.	SKU	EAN	
LU50/85/HO/T/27	50	E27	156	4000	2000	25	28500	1/25	3	35109	90041002351092
LU70/90/HO/T12/27	70	E27	156	6500	2000	25	28500	1/25	3	35112	90041002351122
LU100/100/HO/T/40	100	E40	211	10000	2000	25	28500	1/12	3	35113	90041002351139
LU150/100/HO/T/40	150	E40	211	17500	2000	25	28500	1/12	3	35114	90041002351146
LU250/HO/T/40	250	E40	260	33000	2000	25	28500	1/12	3	35120	90041002351207
LU400/HO/T/40	400	E40	283	56500	2000	25	28500	1/12	3	47963	0043168479639
LU600/HO/T/40	600	E40	283	90000	2000	25	28500	1/12	3	47962	0043168479622
diffúz ● difuzní ● difúzna ● opal ● difuzni ● дифузен ● дифузен ● matt ● difūza ● difuzinis	W	Base	L _{max.}	lm	CCT	Ra	t _(h)	Fig.	SKU	EAN	
LU100/100/HO/D/40	100	E40	186	9600	2000	25	28500	1/12	2	35300	90041002353003
LU150/100/HO/D/40	150	E40	227	16900	2000	25	28500	1/12	2	35301	90041002353010
LU250/HO/D/40	250	E40	227	31200	2000	25	28500	1/12	2	35302	90041002353027
LU400/HO/D/40	400	E40	282	53700	2000	25	28500	1/6	2	35295	90041002352952



Lucalox™ RFL



reflektorbura ● baňka: reflektorová ● banka: reflektorová ● balon: reflectorizant ● balon: reflektorski ● балон: рефлeкторски ● колба: рефлeктор ● kolb: reflektor ● kolba: reflektorveida ● korpusas: reflektorinis	W	Base	L _{max.}	lm	CCT	Ra	t _(h)	Fig.	SKU	EAN	
LU70/RFL	70	E27	144	4000	2000	25	28500	1/10	4	30238	9004102302384



Lucalox™ I*



vilāgos ● čirā ● čira ● clar ● bistra ● просирна ● прозрачна ● klaar ● caurspīdīga ● skaidrus	W	Base	L _{max.}	lm	CCT	Ra	t _(h)	Fig.	SKU	EAN	
LU50/85/I/27	50	E27	156	3400	2000	25	12000	1/12	5	11733	9004102117339
LU70/90/I/27	70	E27	156	6000	2000	25	12000	1/12	5	11735	9004102117353
diffúz ● difuzní ● difúzna ● opal ● difuzni ● дифузен ● дифузен ● matt ● difūza ● difuzinis	W	Base	L _{max.}	lm	CCT	Ra	t _(h)	Fig.	SKU	EAN	
LU50/85/D/I/27	50	E27	156	3300	2000	25	12000	1/12	2	11734	9004102117346
LU70/90/D/I/27	70	E27	156	5800	2000	25	12000	1/12	2	11736	9004102117360



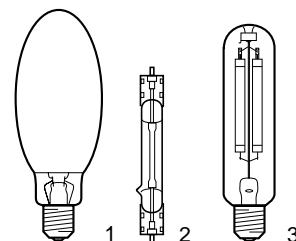
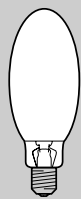

Type	W		L _{max.}	Im	CCT	Ra	t _(h)		Fig.	SKU	EAN
------	---	--	-------------------	----	-----	----	------------------	--	------	-----	-----

Lucalox™ E-Z LUX*



diffúz ● difuzní ● difúzna ● opal ● difuzni ● дифузен ● дифузен ● matt ● difúza ● difuzinis											
LUH110/D27-SHX	110	E27	175	8800	2000	25	16000	1/12	1	39512	0043168395120
LUH215/D/EZ/40	215	E40	232	18000	2000	25	18000	1/12	1	49941	0043168499415



Lucalox™ TD

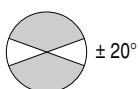

világos ● čirá ● čira ● clar ● bistra ● просирна ● прозрачна ● klaar ● caurspidīga ● skaidrus											
LU250/TD	250	RX7s-24	191	23000	2000	25	20000	1/10	2	30241	9004102302414
LU400/TD	400	RX7s-24	256	43000	2000	25	20000	1/10	2	30244	9004102302445
LU1000/TD	1000	RX7s-24	334	137000	2000	25	20000	1/10	2	30246	9004102302469



Lucalox™ SUPERLIFE



világos ● čirá ● čira ● clar ● bistra ● просирна ● прозрачна ● klaar ● caurspidīga ● skaidrus											
LU50/85/SBY/T/27	50	E27	156	3400	2000	25	40000	1/25	3	35585	9004102355854
LU70/90/SBY/T/27	70	E27	156	6000	2000	25	40000	1/25	3	35593	9004102355939
LU100/100/SBY/T/40	100	E40	211	9600	2000	25	40000	1/12	3	35592	9004102355922
LU150/100/SBY/T/40	150	E40	211	15000	2000	25	50000	1/12	3	35594	9004102355946
LU250/SBY/T/40	250	E40	260	27500	2000	25	55000	1/12	3	35586	9004102355861
LU400/SBY/T/40	400	E40	283	50000	2000	25	55000	1/12	3	35582	9004102355823
diffúz ● difuzní ● difúzna ● opal ● difuzni ● дифузен ● дифузен ● matt ● difúza ● difuzinis											
LU50/85/SBY/D/27	50	E27	156	3300	2000	25	40000	1/12	1	35583	9004102355830
LU70/90/SBY/D/27	70	E27	156	5800	2000	25	40000	1/12	1	35587	9004102355875
LU100/100/SBY/D/40	100	E40	186	9200	2000	25	40000	1/12	1	35588	9004102355885
LU150/100/SBY/D/40	150	E40	227	14500	2000	25	50000	1/12	1	35589	9004102355892
LU250/SBY/D/40	250	E40	227	26000	2000	25	55000	1/12	1	35590	9004102355908
LU400/SBY/D/40	400	E40	282	47500	2000	25	55000	1/6	1	35591	9004102355915



*Belsó amalgamtartályos változat. ● *Bez vnějšího zásobníku amalgámu. ● *Bez vonkajšieho zásobníka amalgámu.

*Fără rezervorul intern cu amalgam. ● *Sa internim amalgamskim rezervoarom. ● *Без вграден амалгамен дозатор. ● *Без вграден амалгамен дозатор. ● *Sisemise amalgam konteineriga. ● *Ar iekšējo amalgāma rezervāru. ● *Su vidiniu amalgamos indu.

120V-os hálózatról elektronikus előtétellel üzemeltetendők

se sít'ovým elektronickým předřadníkem na 120V

so siet'ovým elektronickým predradníkom na 120 V

cu adaptor electronic și funcționare la 120V

sa elektronskiim balastom za mrežni napon od 120V

за мрежен напон од 120 волти и со електронска пригушница

за мрежово напрежение од 120 волта и електронен баласт

120V pinge ja elektroonilise süüteseadmega

120V spriegumam un elektroniskajām droselām

120V elektros tinklui, naudojamus su elektroniniu droseliu

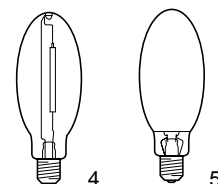

világos ● čirá ● čira ● clar ● bistra ● просирна ● прозрачна ● klaar ● caurspidīga ● skaidrus											
TCE 35W/120V	35	E27	141	2250	1900	–	9000	1/24	4	176132	9004100761312
diffúz ● difuzní ● difúzna ● opal ● difuzni ● дифузен ● дифузен ● matt ● difúza ● difuzinis											
TCED 35W/120V	35	E27	141	2150	1900	–	9000	1/24	5	176222	9004100762210



Különleges csomagolások ● Speciální balení ● Zvláštne balenia
Alte împachetări ● Posebna pakovanja ● Специјална пакувања ● Специјални опаковки
Eripakendid ● Spuldzes speciālā iepakojumā ● Specialios pakuotės

W	V		L _{max.}	Ø	lm	t _(h)		EEC	Fig.	SKU	EAN
---	---	--	-------------------	---	----	------------------	--	-----	------	-----	-----

Normállámpák ● Žárovky obyčejné ● Žiarovky obyčajné

Lámpy normale ● Standardne sijalice ● Стандардни сијалици ● Стандартни лампи
 Standardlambid ● Parastās kvēlspuldzes ● Standartinės lemputės



világos ● čirá ● čira ● clar ● bistra ● просирна ● прозрaчна ● klaar ● caurspidīga ● skaidrus

40	230	E27	105,5	60	415	1000	2/20/40	E	1	510545	9004100094410
60	230	E27	105,5	60	710	1000	2/20/40	E	1	510531	9004100152219
60	230	E27	105,5	60	710	1000	4/120	E	1	510233	9004100102335
100	230	E27	105,5	60	1340	1000	2/20/40	E	1	510530	9004100188218
100	230	E27	105,5	60	1340	1000	4/120	E	1	510514	5994100105145
40/60/100	230	E27	105,5	60	415/710/1340	1000	10	E	1	508159	9004100260587

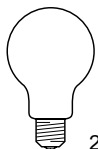

belülhomályosított ● matovaná ● matovaná ● mat ● matirana ● матирана ● матова ● matt ● matēta ● matinis

40	230	E27	105,5	60	415	1000	2/20/40	E	2	510543	9004100140513
60	230	E27	105,5	60	710	1000	2/20/40	E	2	510544	9004100161617
75	230	E27	105,5	60	940	1000	2/20/40	E	2	510546	9004100180618
100	230	E27	105,5	60	1340	1000	2/20/40	E	2	510846	9004100194714
25/40/60/100	230	E27	105,5	60	230/415/710/1340	1000	10	E	2	511562	5994100115625

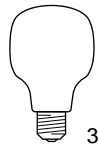

TUNGSRASOFT

opál ● opalizovaná ● opalizovaná ● opal ● mlečna ● млечна ● онал ● opaal ● opāls ● opalinis

60	230	E27	105,5	60	620	1000	2/40	F	3	510525	5994100105251
----	-----	-----	-------	----	-----	------	------	---	---	--------	---------------

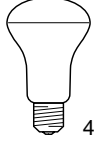

SUPERBALUX

opalizált, szatírozott buratetővel ● opalizovaná, se satinovaným vrchlíkom ● opalizovaná so satinovaným vrchlíkom

opal, capacul balonului satinat ● mlečna sa satenskim vrhom ● млечна со сатенизиран врв ● опализирана със сатиринан върх

opaal, ots matt ● opāls ar satinizētu virsmu ● opalinis, viršus matinis

60	230	E27	92	50	700	1000	2/40	E	4	510524	5994100105251
----	-----	-----	----	----	-----	------	------	---	---	--------	---------------



Dekorációs gömblámpák ● Žárovky ilumináčnı ● Dekorativne guličkové žiarovky

Lámpy decorative sferice ● Dekorativne okrugle sijalice ● Декоративни тркалезни сијалици

Декоративни сферични лампи ● Dekoratiivlambid ● Dekoratiivās spuldzes ● Dekoratyvinės rutulinės lemputės

világos ● čirá ● čira ● clar ● bistra ● просирна ● прозрaчна ● klaar ● caurspidīga ● skaidrus

40	230	E14	79	45	400	1000	2/40	E	5	510549	5994100105497
40	230	E14	79	45	400	1000	2/40	E	6	510335	5994100626918
40	230	E27	74	45	400	1000	2/40	E	7	510341	5994100309125

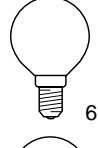

opál ● opalizovaná ● opalizovaná ● opal ● mlečna ● млечна ● онал ● opaal ● opāls ● opalinis

40	220-230	E14	79	45	360	1000	2/40	F	6	510284	5994100102847
----	---------	-----	----	----	-----	------	------	---	---	--------	---------------

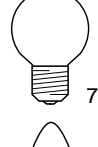

Gyertyalámpák ● Žárovky svičkové ● Sviečkové žiarovky

Lámpy luménare ● Sveća sijalice ● Свеќа сијалици ● Лампи-свещ

Küünallambid ● Svečveida spuldzes ● Lemputės-žvakutės

világos ● čirá ● čira ● clar ● bistra ● просирна ● прозрaчна ● klaar ● caurspidīga ● skaidrus

40	230	E14	100	35	400	1000	2/40	E	8	510523	5994100105237
25	230	E14	100	35	200	1000	2/40	F	9	510485	5994100207728
40	230	E14			400	1000	2/40	E	9	510816	5994100207926



opál ● opalizovaná ● opalizovaná ● opal ● mlečna ● млечна ● онал ● opaal ● opāls ● opalinis

40	230	E14	100	35	400	1000	2/40	F	9	510526	5994100105268
----	-----	-----	-----	----	-----	------	------	---	---	--------	---------------

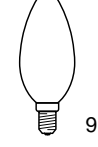

Reflektorlámpák ● Reflektorové žárovky ● Reflektorové žiarovky

Lámpy reflector ● Reflektorske sijalice ● Рефлекторски сијалици ● Рефлектни лампи

Reflektorlambid ● Reflektorspuldzes ● Reflektorinės lemputės

TUNGSRFLEX

R50 (ø 50 mm), 35°

25	230	E14	86	50	130 cd	1000	2/40	-	10	510814	5994100412924
40	230	E14	86	50	250 cd	1000	2/40	-	10	510515	5994100105152

R63 (ø 63 mm), 35°

60	230	E27	103	63	550 cd	1000	2/40	-	11	510510	5994100105107
----	-----	-----	-----	----	--------	------	------	---	----	--------	---------------

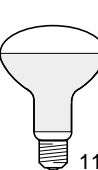
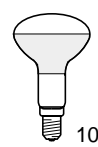

Type

W

V

L_{max.}

Im

t_(h)

EEC

Fig.

SKU

EAN

Kisfeszültségű halogén reflektorlámpák ● Halogenové reflektorové žárovky pro malé napětí

Halogénové reflektorové žiarovky na malé napätia ● Lāmpi halogene de tensiune redusă

Niskonaponske halogene reflektorske sijalice ● Нисконапонски халогени сијалици

Ниско напрежение халогени лампи ● Reflektoriga madalapingehalogenlambid

Zemsprieguma halogēnspludzes ● Žemos lāmpas halogeninės reflektorinės lemputės

Precise™ Bright MR16 – ø 50 mm, 36°, 3000K

zárt hiedetűkör ● s uzavřeným studeným zrcadlem ● uzatvorene so studeným zrkadlom ● oglindă dicroic închiși ● zatvoreno dihroik ogledalo

затворено дихроик огледало ● затворено дихроично огледало ● suletud dikroidreflektor ● slēgts dihroisks spogulis ● uždardas dichroinis veidrodis

52330 WFL BAB/CG	20	12	GU5,3	–	–	450	4000	1/50 blister	–	1	510795	5994100107958
52360 WFL EXN/CG	50	12	GU5,3	–	–	2100	4000	1/50 blister	–	1	510794	5994100107941

Egy végén fejtelt, kisfeszültségű halogénlámpák ● Jednopicové halogenové žárovky pro malé napětí

Jednostranne päticované halogénové žiarovky na malé napätia

Lāmpi halogene de tensiune redusă cu racord la un capăt ● Niskonaponske halogene sijalice sa jednim podnožjom

Нисконапонски едностранни халогени сијалици ● Ниско напрежение халогени лампи с едностранен цокъл

Ūhe sokliga madalapingehalogenlambid ● Zemsprieguma vienkotakta halogēnspludzes

Žemos lāmpas halogeninės lemputės su viename gale esančiais išvadais

világos ● čirá ● čira ● clar ● bistra ● просирна ● прозрачна ● klaar ● caurspidīga ● skaidrus

56040	20	12	G4	33	9	380	2000	1/50 blister	–	2	510558	5994100105589
56500	50	12	GY6,35-15	44	11	900	2000	1/50 blister	–	3	510556	5994100105565
58600	10	12	G4	33	9	140	2000	1/50 blister	–	2	510557	5994100105572

Két végén fejtelt, hálózati feszültségű halogénlámpák ● Obustranně päticované halogenové žárovky na síťové napětí

Obojstranne päticované halogénové žiarovky na sieťové napätie ● Lāmpi halogene cu racord la ambele capete

Halogene sijalice sa dva podnožja za mrežni napon ● Двострани халогени сијалици за мрежен напон

Халогени лампи с двустранен цокъл за мрежово напрежение

Kahesokkilised võrgupingel töötavad halogenlambid ● Pamatsprieguma divkontakta halogēnspludzes

Elektros tinklo lāmpas halogeninės lemputės su išvadais abiejuose galuose

STANDARD

világos ● čirá ● čira ● clar ● bistra ● просирна ● прозрачна ● klaar ● caurspidīga ● skaidrus

51000	300	120	R7s	117,6	8	5950	2000	1/50 blister	D	4	174060	9004100740416
51020	300	240	R7s	117,6	8	5100	2000	1/50 blister	E	4	174192	9004100174198
50010	500	120	R7s	117,6	10	11000	2000	1/50 blister	–	4	174300	9004100742915
50000	500	240	R7s	117,6	10	9500	2000	1/50 blister	–	4	174513	9004100174518

START

világos ● čirá ● čira ● clar ● bistra ● просирна ● прозрачна ● klaar ● caurspidīga ● skaidrus

K28/E	150	230	R7s	117,6	8	2100	2000	2/20 blister	E	4	510428	5994100104285
K28/E	150	240	R7s	117,6	8	2100	1500	2/20 blister	E	4	510429	5994100104292
K9/E	300	230	R7s	117,6	8	5100	2000	2/20 blister	E	4	510430	5994100104308
K9/E	300	240	R7s	117,6	8	5100	1500	2/20 blister	E	4	510426	5994100104261
K1/E	500	230	R7s	117,6	10	9800	2000	2/20 blister	–	4	510431	5994100104315
K1/E	500	240	R7s	117,6	10	9500	1500	2/20 blister	–	4	510427	5994100104278

FAM

Dekorációs gömblámpák ● Žárovky iluminacní ● Dekorativne guličkové žiarovky ● Lāmpi decorative sferice

Dekorativne okrugle sijalice ● Декоративни тркалезни сијалици ● Декоративни сферични лампи

Dekoriativlambid ● Dekoriativās spuldzes ● Dekoriativinės rutulinės lemputės

opál ● opalizovaná ● opalizovaná ● opal ● mlečna ● млечна ● опал ● opaal ● opāls ● opalinis

5 x 30 x 2	40	230	E14	79	45	360	1000	300	F	5	510547	5994100102847
------------	----	-----	-----	----	----	-----	------	-----	---	---	--------	---------------

Gyertyalámpák ● Žárovky svíčkové ● Sviečkové žiarovky ● Lāmpi lumānare ● Sveča sijalice ● Свеќа сијалици

Лампи-свеќ ● Kūūnallambid ● Svečveida spuldzes ● Lempūtės-žvakutės

opál ● opalizovaná ● opalizovaná ● opal ● mlečna ● млечна ● опал ● opaal ● opāls ● opalinis

4 x 44 x 2	40	230	E14	100	35	400	1000	352	F	6	510548	5994100105268
------------	----	-----	-----	-----	----	-----	------	-----	---	---	--------	---------------

Reflektorlámpák ● Reflektorové žárovky ● Reflektorové žiarovky

Lāmpi reflector ● Reflektorske sijalice ● Рефлекторски сијалици ● Рефлектни лампи

Reflektorlambid ● Reflektorspludzes ● Reflektorinės lemputės

TUNGSRAFLEX – R50 (ø 50 mm)

4 x 35 x 2	40	230	E14	86	50	250 cd	1000	280	–	7	510527	5994100105152
------------	----	-----	-----	----	----	--------	------	-----	---	---	--------	---------------

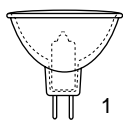

1

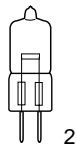

2

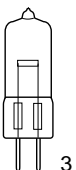

3

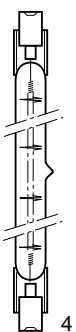

4



5



6

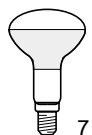

7