

KATALÓG PRODUKTOV 2012

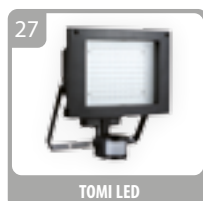

LED ZDROJE A SVIETIDLÁ

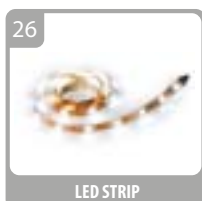
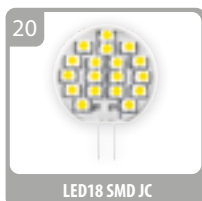

TECHNICKÉ SVIETIDLÁ

30



DUST metal

31



DUST premium

32



DUST EVG PC

33



DUST VVG PC

34



DUST EVG PS

35



DUST VVG PS

36



UGO

36

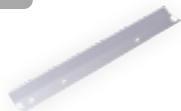

Reflektor UGO

37



MIRA

38



GEMINI EVG

39



GEMINI VVG

40



ARIES EVG

40



ARIES VVG

41



ORI EVG

42



ORI VVG

43



TAU EVG

43



TAU VVG

44



TOR 3

44



TOR 2

45



TOR 1

45



RONDE E27

46



HALO 150

46



HALO 500

47



TOMI 150

47



TOMI 500

48



HALO 2E27

48



TOMI E27

49



MH4 E40

49



MH5 E40

50



MH6 RX7S

50



MH3 RX7S

51



MH2 RX7S

PODHLADOVÉ BODOVÉ SVIETIDLÁ



SVETELNÉ ZDROJE

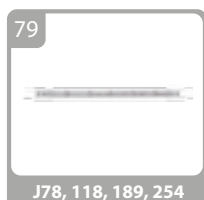

ELEKTROINŠTALAČNÝ MATERIÁL

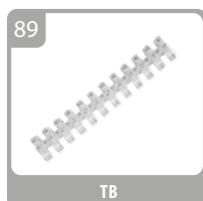
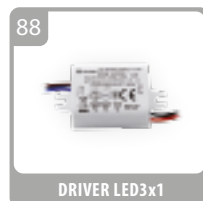
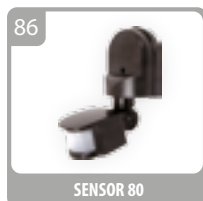
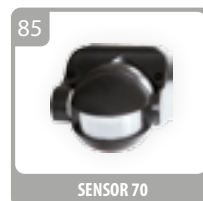
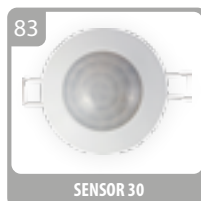

DESIGNOVÉ SVIETIDLÁ

98



TAURUS 1E27

98



TAURUS 2E27

99

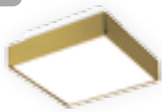

PERSEUS 1E27

99



PERSEUS 2E27

100



CETUS 2E27

100



ARA E27

101



VELA HF E27

101



MANA 2E27

102



KABINET

102



KABINET

| KÓD | NÁZOV VÝROBKU | STRANA |
|---------|------------------------------|--------|
| GXIZ015 | ARA E27 | 100 |
| GXRV001 | ARIES EVG 4K18W | 40 |
| GXRV003 | ARIES VVG 4K18W | 40 |
| GXPP007 | AXL 2114-A | 53 |
| GXPP006 | AXL 2114-BRM | 53 |
| GXPP008 | AXL 2114-C | 53 |
| GXPP009 | AXL 2114-CM | 53 |
| GXPP004 | AXL 2114-G | 53 |
| GXPP010 | AXL 2114-GM | 53 |
| GXPP003 | AXL 2114-W | 53 |
| GXPP052 | AXL 2114-YGM | 53 |
| GXPP034 | AXL 2115-A | 54 |
| GXPP033 | AXL 2115-BRM | 54 |
| GXPP035 | AXL 2115-C | 54 |
| GXPP036 | AXL 2115-CM | 54 |
| GXPP031 | AXL 2115-G | 54 |
| GXPP037 | AXL 2115-GM | 54 |
| GXPP030 | AXL 2115-W | 54 |
| GXPP053 | AXL 2115-YGM | 54 |
| GXPP041 | AXL 2117-A | 55 |
| GXPP040 | AXL 2117-BRM | 55 |
| GXPP042 | AXL 2117-C | 55 |
| GXPP043 | AXL 2117-CM | 55 |
| GXPP039 | AXL 2117-G | 55 |
| GXPP044 | AXL 2117-GM | 55 |
| GXPP054 | AXL 2117-YGM | 55 |
| GXPP014 | AXL 3114-PG/N | 57 |
| GXPP013 | AXL 3114-PS/G | 57 |
| GXPP011 | AXL 3114-SM/G | 57 |
| GXPP012 | AXL 3114-SM/N | 57 |
| GXPP049 | AXL 3115-GM/N | 57 |
| GXPP048 | AXL 3115-PG/N | 57 |
| GXPP047 | AXL 3115-PS/G | 57 |
| GXPP045 | AXL 3115-SM/G | 57 |
| GXPP046 | AXL 3115-SM/N | 57 |
| GXPL003 | AXL 5514-A | 58 |
| GXPL004 | AXL 5514-C | 58 |
| GXPL005 | AXL 5514-CM | 58 |
| GXPL016 | AXL 5514-PCM/N | 59 |
| GXPL017 | AXL 5514-PG/N | 59 |
| GXPL020 | AXL 5514-SG/N | 59 |
| GXPL018 | AXL 5514-SM/G | 59 |
| GXPL019 | AXL 5514-SM/N | 59 |
| GXPL001 | AXL 5514-W | 58 |
| GXPL026 | AXL 5515-A | 58 |
| GXPL028 | AXL 5515-C | 58 |
| GXPL029 | AXL 5515-CM | 58 |
| GXPL041 | AXL 5515-PCM/N | 59 |
| GXPL042 | AXL 5515-PG/N | 59 |
| GXPL045 | AXL 5515-SG/N | 59 |
| GXPL043 | AXL 5515-SM/G | 59 |
| GXPL044 | AXL 5515-SM/N | 59 |
| GXPL024 | AXL 5515-W | 58 |
| GXPA001 | AXL DS050-AL | 62 |
| GXPL021 | AXL DS14-PS/N | 60 |
| GXPL022 | AXL DS14-SM/G | 60 |
| GXPA003 | AXL DT050-AL | 62 |
| GXOS038 | Bezšroubová svorkovnice WG-2 | 89 |
| GXOS039 | Bezšroubová svorkovnice WG-3 | 89 |
| GXOS040 | Bezšroubová svorkovnice WG-4 | 89 |
| GXOS041 | Bezšroubová svorkovnice WG-5 | 89 |
| GXOS042 | Bezšroubová svorkovnice WG-8 | 89 |
| GXZK016 | BUDHA 4U 9W E14 | 70 |
| GXZK017 | BUDHA 4U 9W E27 | 70 |
| GXZK018 | BUDHA 4U 11W E14 | 70 |
| GXZK019 | BUDHA 4U 11W E27 | 70 |
| GXZK020 | BUDHA 4U 15W E27 | 70 |
| GXZK021 | BUDHA 4U 18W E27 | 70 |
| GXZK022 | BUDHA 4U 20W E27 | 70 |
| GXZK023 | BUDHA 5U 24W E27 | 70 |
| GXZK038 | CANDLE 7W E14 | 75 |
| GXZK039 | CANDLE 9W E14 | 75 |

| KÓD | NÁZOV VÝROBKU | STRANA |
|---------|------------------------------|----------------|
| GXIZ013 | CETUS 2E27 GR | 100 |
| GXIZ014 | CETUS 2E27 W | 100 |
| GXZK002 | CLASSIC 9W E14 | 67 |
| GXZK004 | CLASSIC 11W E14 | 67 |
| GXZK003 | CLASSIC 11W E27 | 67 |
| GXZK006 | CLASSIC 15W E14 | 67 |
| GXZK005 | CLASSIC 15W E27 | 67 |
| GXZK051 | CLASSIC 20W E27 | 67 |
| GXZK052 | CLASSIC 23W E27 | 67 |
| GXOS014 | Difuzor - DUST metal 2x36W | 30 |
| GXOS018 | Difuzor - DUST PC 1x18W | 33 |
| GXOS020 | Difuzor - DUST PC 1x36W | 33 |
| GXOS022 | Difuzor - DUST PC 1x58W | 33 |
| GXOS019 | Difuzor - DUST PC 2x18W | 33 |
| GXOS021 | Difuzor - DUST PC 2x36W | 32,33 |
| GXOS023 | Difuzor - DUST PC 2x58W | 32,33 |
| GXOS002 | Difuzor - DUST premium 2x36W | 31 |
| GXOS008 | Difuzor - DUST premium 2x58W | 31 |
| GXOS024 | Difuzor - DUST PS 1x18W | 35 |
| GXOS026 | Difuzor - DUST PS 1x36W | 35 |
| GXOS028 | Difuzor - DUST PS 1x58W | 35 |
| GXOS025 | Difuzor - DUST PS 2x18W | 35 |
| GXOS027 | Difuzor - DUST PS 2x36W | 34,35 |
| GXOS029 | Difuzor - DUST PS 2x58W | 34,35 |
| GXLD002 | DRIVER LED30 | 88 |
| GXLD001 | DRIVER LED3x1 | 88 |
| GXOS035 | Držiak - DUST EVG,VVG | 32, 33, 34, 35 |
| GXOS016 | Držiak - DUST metal 2x36W | 30 |
| GXOS004 | Držiak - DUST premium | 31 |
| GXPP023 | DUFF 204-C | 56 |
| GXPP024 | DUFF 204-CM | 56 |
| GXPP050 | DUFF 205-C | 56 |
| GXPP051 | DUFF 205-CM | 56 |
| GXWP005 | DUST EVG PC 2x36W | 32 |
| GXWP006 | DUST EVG PC 2x58W | 32 |
| GXWP013 | DUST EVG PS 2x36W | 34 |
| GXWP014 | DUST EVG PS 2x58W | 34 |
| GXWP004 | DUST metal 2x36W | 30 |
| GXWP001 | DUST premium 2x36W | 31 |
| GXWP002 | DUST premium 2x58W | 31 |
| GXWP007 | DUST VVG PC 1x18W | 33 |
| GXWP009 | DUST VVG PC 1x36W | 33 |
| GXWP011 | DUST VVG PC 1x58W | 33 |
| GXWP008 | DUST VVG PC 2x18W | 33 |
| GXWP010 | DUST VVG PC 2x36W | 33 |
| GXWP012 | DUST VVG PC 2x58W | 33 |
| GXWP015 | DUST VVG PS 1x18W | 35 |
| GXWP017 | DUST VVG PS 1x36W | 35 |
| GXWP019 | DUST VVG PS 1x58W | 35 |
| GXWP016 | DUST VVG PS 2x18W | 35 |
| GXWP018 | DUST VVG PS 2x36W | 35 |
| GXWP020 | DUST VVG PS 2x58W | 35 |
| GXZK041 | EddyCANDLE 7W E14 | 75 |
| GXZH024 | G9 25W | 79 |
| GXZH025 | G9 40W | 79 |
| GXRPO02 | GEMINI EVG 2x36W | 38 |
| GXRPO01 | GEMINI EVG 4x18W | 38 |
| GXRPO06 | GEMINI VVG 2x36W | 39 |
| GXRPO05 | GEMINI VVG 4x18W | 39 |
| GXZK034 | GLOBE 11W E14 | 73 |
| GXZK035 | GLOBE 11W E27 | 73 |
| GXZK036 | GLOBE 15W E27 | 73 |
| GXZK037 | GLOBE 20W E27 | 73 |
| GXER008 | HALO 150 B | 46 |
| GXER009 | HALO 150 W | 46 |
| GXER007 | HALO 2E27 B | 48 |
| GXER010 | HALO 500 B | 46 |
| GXER011 | HALO 500 W | 46 |
| GXL5003 | HALO LED 117 B | 27 |
| GXL5025 | HALO MCOB 10W | 28 |
| GXL5026 | HALO MCOB 30W | 28 |

| KÓD | NÁZOV VÝROBKU | STRANA |
|---------|-------------------------------|----------------|
| GXLS027 | HALO MCOB 50W | 28 |
| GXPLO09 | IZZY D510-AB | 61 |
| GXPLO10 | IZZY D510-C | 61 |
| GXPLO11 | IZZY D510-SN | 61 |
| GXPLO46 | IZZY D510-YGM | 61 |
| GXPA002 | IZZY D5L50-AL | 63 |
| GXPLO33 | IZZY DT10-AB | 61 |
| GXPLO34 | IZZY DT10-C | 61 |
| GXPLO35 | IZZY DT10-CM | 61 |
| GXPLO47 | IZZY DT10-YGM | 61 |
| GXPA004 | IZZY DTLS0 PA16V-AL | 63 |
| GXZH004 | J118 100W | 79 |
| GXZH005 | J118 150W | 79 |
| GXZH006 | J118 200W | 79 |
| GXZH007 | J118 300W | 79 |
| GXZH008 | J118 500W | 79 |
| GXZH009 | J189 1000W | 79 |
| GXZH010 | J254 1500W | 79 |
| GXZH001 | J78 60W | 79 |
| GXZH002 | J78 100W | 79 |
| GXZH003 | J78 150W | 79 |
| GXZH027 | JC 5W G4 | 78 |
| GXZH028 | JC 10W G4 | 78 |
| GXZH029 | JC 20W G4 | 78 |
| GXZH031 | JC 20W GY6,35 | 78 |
| GXZH030 | JC 35W G4 | 78 |
| GXZH032 | JC 35W GY6,35 | 78 |
| GXZH033 | JC 50W GY6,35 | 78 |
| GXZH021 | JCDR 25W 38 | 80 |
| GXZH022 | JCDR 35W 38 | 80 |
| GXZH023 | JCDR 50W 38 | 80 |
| GXZH018 | JDR 25W 60 | 80 |
| GXZH019 | JDR 35W 60 | 80 |
| GXZH020 | JDR 50W 60 | 80 |
| GXIP002 | KABINET 13W | 102 |
| GXIP003 | KABINET 21W | 102 |
| GXIP004 | KABINET 28W | 102 |
| GXIP001 | KABINET 8W | 102 |
| GXIP005 | KABINET prepojovací kábel | 102 |
| GXOS037 | Klip nerez - DUST EVG,VVG | 32, 33, 34, 35 |
| GXOS017 | Klip nerez - DUST metal 2x36W | 30 |
| GXOS006 | Klip nerez - DUST premium | 31 |
| GXOS036 | Klip PC - DUST EVG,VVG | 32, 33, 34, 35 |
| GXOS005 | Klip PC - DUST premium | 31 |
| GXLZ040 | LED MCOB E27 5W - CW | 13 |
| GXLZ041 | LED MCOB E27 5W - WW | 13 |
| GXLZ011 | LED POWER GU10 1x3W - CW | 24 |
| GXLZ012 | LED POWER GU10 1x3W - WW | 24 |
| GXLZ009 | LED POWER GU10 3x1W - CW | 24 |
| GXLZ010 | LED POWER GU10 3x1W - WW | 24 |
| GXLZ015 | LED POWER MR16 1x3W - CW | 25 |
| GXLZ016 | LED POWER MR16 1x3W - WW | 25 |
| GXLZ013 | LED POWER MR16 3x1W - CW | 25 |
| GXLZ014 | LED POWER MR16 3x1W - WW | 25 |
| GXLS007 | LED STRIP 5m BL | 26 |
| GXLS009 | LED STRIP 5m CW | 26 |
| GXLS008 | LED STRIP 5m GN | 26 |
| GXLS014 | LED STRIP 5m IP65 BL | 26 |
| GXLS016 | LED STRIP 5m IP65 CW | 26 |
| GXLS015 | LED STRIP 5m IP65 GN | 26 |
| GXLS013 | LED STRIP 5m IP65 OR | 26 |
| GXLS011 | LED STRIP 5m IP65 RE | 26 |
| GXLS017 | LED STRIP 5m IP65 WW | 26 |
| GXLS012 | LED STRIP 5m IP65 YE | 26 |
| GXLS006 | LED STRIP 5m OR | 26 |
| GXLS004 | LED STRIP 5m RE | 26 |
| GXLS010 | LED STRIP 5m WW | 26 |
| GXLS005 | LED STRIP 5m YE | 26 |
| GXLZ047 | LED13 SMD 5050 JC 2W - CW | 20 |
| GXLZ053 | LED13 SMD 5050 JC 2W - WW | 20 |
| GXLZ052 | LED18 SMD JC 1W - CW | 20 |
| GXLZ046 | LED18 SMD JC 1W - WW | 20 |

| KÓD | NÁZOV VÝROBKU | STRANA | KÓD | NÁZOV VÝROBKU | STRANA | KÓD | NÁZOV VÝROBKU | STRANA |
|---------|-----------------------------|--------|---------|-------------------------------|----------------|---------|--------------------|--------|
| GXLZ051 | LED24 SMD 5050 E14 4W - CW | 17 | GXS002 | MIRA 2x18W | 37 | GKSE005 | SENSOR 80 W | 86 |
| GXLZ050 | LED24 SMD 5050 E14 4W - WW | 17 | GXS001 | MIRA 2x36W | 37 | GXPP001 | SLASH 2113-C | 53 |
| GXLZ044 | LED24 SMD 5050 GU10 4W - CW | 13 | GXS007 | Montážna konzola - ARIES | 40 | GXPP002 | SLASH 2113-CM | 53 |
| GXLZ045 | LED24 SMD 5050 GU10 4W - WW | 13 | GXZH011 | MR11 20W 30 | 77 | GXPP028 | SLASH 2118-C | 55 |
| GXLZ017 | LED30 GU10 1,5W - CW | 22 | GXZH012 | MR11 35W 30 | 77 | GXPP025 | SLASH 2119-C | 54 |
| GXLZ018 | LED30 GU10 1,5W - WW | 22 | GXZH013 | MR16 20W 36 | 77 | GXPP026 | SLASH 2119-CM | 54 |
| GXLZ023 | LED30 MR16 1,5W - CW | 23 | GXZH014 | MR16 20W 60 | 77 | GXPL023 | SLASH 5519-PCM | 60 |
| GXLZ024 | LED30 MR16 1,5W - WW | 23 | GXZH015 | MR16 35W 36 | 77 | GXPL036 | SLASH 5519-PCM/N | 60 |
| GXLZ003 | LED30 SMD GU10 2W - CW | 15 | GXZH016 | MR16 35W 60 | 77 | GXPL040 | SLASH 5519-SM/N | 60 |
| GXLZ004 | LED30 SMD GU10 2W - WW | 15 | GXZH017 | MR16 50W 60 | 77 | GXZK025 | SPIRE 9W E14 | 72 |
| GXLZ007 | LED30 SMD MR16 2W - CW | 19 | GXOS049 | Objímka LH-E14 | 91 | GXZK026 | SPIRE 9W E27 | 72 |
| GXLZ008 | LED30 SMD MR16 2W - WW | 19 | GXOS046 | Objímka LH-E27 | 91 | GXZK028 | SPIRE 11W E14 | 72 |
| GXLZ019 | LED48 GU10 2,4W - CW | 21 | GXOS048 | Objímka LH-E27D | 91 | GXZK027 | SPIRE 11W E27 | 72 |
| GXLZ020 | LED48 GU10 2,4W - WW | 21 | GXOS047 | Objímka LH-E27F | 91 | GXZK029 | SPIRE 15W E27 | 72 |
| GXLZ025 | LED48 MR16 2,4W - CW | 23 | GXOS045 | Objímka LH-GX5,3 | 90 | GXZK030 | SPIRE 20W E27 | 72 |
| GXLZ026 | LED48 MR16 2,4W - WW | 23 | GXOS043 | Objímka LH-GZ10 | 90 | GXZK066 | SPIRE 25W E27 - CW | 72 |
| GXLZ001 | LED48 SMD GU10 3,5W - CW | 14 | GXOS044 | Objímka LH-R75 | 90 | GXZK065 | SPIRE 25W E27 - WW | 72 |
| GXLZ002 | LED48 SMD GU10 3,5W - WW | 14 | GXZK032 | OpenGLOBE 15W E27 | 74 | GXZK024 | SPIRE 7W E14 | 72 |
| GXLZ005 | LED48 SMD MR16 3,5W - CW | 18 | GXZK033 | OrbGLOBE 20W E27 | 74 | GXZK054 | SPOT 9W GU10 | 76 |
| GXLZ006 | LED48 SMD MR16 3,5W - WW | 18 | GXRPO08 | ORI EVG 2x36W | 41 | GXZK055 | SPOT 11W GU10 | 76 |
| GXLZ021 | LED60 GU10 3W - CW | 21 | GXRPO07 | ORI EVG 4x18W | 41 | GXOS090 | Starter 4-22W | 96 |
| GXLZ022 | LED60 GU10 3W - WW | 21 | GXRPO04 | ORI VVG 2x36W | 42 | GXOS091 | Starter 4-65W | 96 |
| GXLZ027 | LED60 MR16 3W - CW | 22 | GXRPO03 | ORI VVG 4x18W | 42 | GXOS080 | TAPE/10-B | 95 |
| GXLZ028 | LED60 MR16 3W - WW | 22 | GXPP019 | OZZY 2116B-A | 64 | GXOS081 | TAPE/10-MIX | 95 |
| GXLZ038 | LED60 SMD E14 4W - CW | 17 | GXPP018 | OZZY 2116B-BRM | 64 | GXOS082 | TAPE/20-B | 95 |
| GXLZ037 | LED60 SMD E14 4W - WW | 17 | GXPP020 | OZZY 2116B-C | 64 | GXOS083 | TAPE/20-MIX | 95 |
| GXLZ034 | LED60 SMD E27 4W - CW | 16 | GXPP021 | OZZY 2116B-CM | 64 | GXRVO09 | TAU EVG 4X18W | 43 |
| GXLZ033 | LED60 SMD E27 4W - WW | 16 | GXPP017 | OZZY 2116B-G | 64 | GXRVO02 | TAU VVG 4X18W | 43 |
| GXLZ032 | LED60 SMD GU10 4W - CW | 14 | GXPP016 | OZZY 2116B-W | 64 | GXZ003 | TAURUS 1E27 G | 98 |
| GXLZ031 | LED60 SMD GU10 4W - WW | 14 | GXPP022 | OZZY 2116B-YGM | 64 | GXZ001 | TAURUS 1E27 GR | 98 |
| GXLZ042 | LED60 SMD JCDR 3W - CW | 15 | GXPL014 | OZZY 2116C-C | 64 | GXZ002 | TAURUS 1E27 W | 98 |
| GXLZ043 | LED60 SMD JCDR 3W - WW | 15 | GXPL015 | OZZY 2116C-CM | 64 | GXZ006 | TAURUS 2E27 G | 98 |
| GXLZ030 | LED60 SMD MR16 4W - CW | 18 | GXPL013 | OZZY 2116C-CM | 64 | GXZ004 | TAURUS 2E27 GR | 98 |
| GXLZ029 | LED60 SMD MR16 4W - WW | 18 | GXPL012 | OZZY 2116C-W | 64 | GXZ005 | TAURUS 2E27 W | 98 |
| GXLZ049 | LED80 SMD E27 5W - CW | 16 | GXZ009 | PERSEUS 1E27 G | 99 | GXOS093 | TB - 2,5 mm PE | 89 |
| GXLZ048 | LED80 SMD E27 5W - WW | 16 | GXZ007 | PERSEUS 1E27 GR | 99 | GXOS094 | TB - 4 mm PE | 89 |
| GXLZ036 | LED9 SMD 5050 MR11 2W - WW | 19 | GXZ008 | PERSEUS 1E27 W | 99 | GXOS095 | TB - 6 mm PE | 89 |
| GXZK042 | LOTOS 4U 11W E27 | 71 | GXZ012 | PERSEUS 2E27 G | 99 | GXOS096 | TB - 10 mm PE | 89 |
| GXZK043 | LOTOS 4U 15W E27 | 71 | GXZ010 | PERSEUS 2E27 GR | 99 | GXOS097 | TB - 16 mm PE | 89 |
| GXZK044 | LOTOS 4U 20W E27 | 71 | GXZ011 | PERSEUS 2E27 W | 99 | GXER001 | TOMI 150 B | 47 |
| GXZK050 | LOTOS 5U 14W E14 | 71 | GXOS034 | Priechodka - DUST EVG, VVG | 32, 33, 34, 35 | GXER002 | TOMI 150 W | 47 |
| GXZK045 | LOTOS 5U 25W E27 | 71 | GXOS013 | Priechodka - DUST metal 2x36W | 30 | GXER006 | TOMI 1E27 B | 48 |
| GXIZ017 | MANA 2E27 | 101 | GXOS001 | Priechodka - DUST premium | 31 | GXER005 | TOMI 2E27 B | 48 |
| GXZK046 | MAXI 5U 11W E14 | 69 | GXOS030 | Predradnik - EVG 2x36W | 32 | GXER003 | TOMI 500 B | 47 |
| GXZK047 | MAXI 5U 11W E27 | 69 | GXOS030 | Predradnik - EVG 2x36W | 34 | GXER004 | TOMI 500 W | 47 |
| GXZK048 | MAXI 5U 15W E14 | 69 | GXOS030 | Predradnik - EVG 2x36W | 92 | GXLS001 | TOMI LED 60 B | 27 |
| GXZK049 | MAXI 5U 15W E27 | 69 | GXOS031 | Predradnik - EVG 2x58W | 32 | GXLS002 | TOMI LED 117 B | 27 |
| GXMHO13 | MH2 RX75 70W | 51 | GXOS031 | Predradnik - EVG 2x58W | 34 | GXTT006 | TOR 1-100 | 45 |
| GXMHO15 | MH2 RX75 70W/AS | 51 | GXOS031 | Predradnik - EVG 2x58W | 92 | GXTT005 | TOR 2-60 | 44 |
| GXMHO14 | MH2 RX75 150W | 51 | GXOS003 | Predradnik - EVG DP 2x36W | 30 | GXTT004 | TOR 2-60/P | 44 |
| GXMHO16 | MH2 RX75 150W/AS | 51 | GXOS003 | Predradnik - EVG DP 2x36W | 31 | GXTT003 | TOR 3-100/M | 44 |
| GXMHO11 | MH3 RX75 70W | 50 | GXOS032 | Predradnik - EVG DP 2x36W | 92 | GXTT001 | TOR 3-60/M | 44 |
| GXMHO12 | MH3 RX75 150W | 50 | GXOS009 | Predradnik - EVG DP 2x58W | 31 | GXTT002 | TOR 3-60/P | 44 |
| GXMHO01 | MH4 E40 250W | 49 | GXOS033 | Predradnik - EVG DP 2x58W | 92 | GXOS053 | TRAF0 ET 20 | 87 |
| GXMHO03 | MH4 E40 250W/AS | 49 | GXOS052 | Predradnik - VVG 18W | 92 | GXOS054 | TRAF0 ET 60 | 87 |
| GXMHO02 | MH4 E40 400W | 49 | GXOS032 | Predradnik - VVG 36W | 92 | GXOS055 | TRAF0 ET105 | 87 |
| GXMHO04 | MH4 E40 400W/AS | 49 | GXOS033 | Predradnik - VVG 58W | 92 | GXOS056 | TRAF0 ET150 | 87 |
| GXMHO05 | MH5 E40 250W | 49 | GXOS010 | Reflector - UGO 1x36W | 36 | GXOS057 | TRAF0 ET210 | 87 |
| GXMHO07 | MH5 E40 250W/AS | 49 | GXOS011 | Reflector - UGO 2x36W | 36 | GXOS058 | TRAF0 SLIM60 | 87 |
| GXMHO06 | MH5 E40 400W | 49 | GXTT008 | RONDE E27 | 45 | GXOS059 | TRAF0 SLIM80 | 87 |
| GXMHO08 | MH5 E40 400W/AS | 49 | GXOS060 | Rozbočka R02-1 | 93 | GXIK006 | UGO 1x18W | 36 |
| GXMHO09 | MH6 RX75 70W/AS | 50 | GXOS061 | Rozbočka R03 | 93 | GXIK001 | UGO 1x36W | 36 |
| GXMHO10 | MH6 RX75 150W/AS | 50 | GXSI001 | SENSOR 10 | 83 | GXIK002 | UGO 1x58W | 36 |
| GXZK007 | MINI 4U 9W E14 | 68 | GXSI002 | SENSOR 20 | 83 | GXIK003 | UGO 2x18W | 36 |
| GXZK010 | MINI 4U 9W E27 | 68 | GXSI003 | SENSOR 30 | 83 | GXIK004 | UGO 2x36W | 36 |
| GXZK008 | MINI 4U 11W E14 | 68 | GXSI004 | SENSOR 40 | 84 | GXIK005 | UGO 2x58W | 36 |
| GXZK011 | MINI 4U 11W E27 | 68 | GXSI005 | SENSOR 50 | 84 | GXIZ016 | VELA HF E27 | 101 |
| GXZK012 | MINI 4U 13W E27 | 68 | GKSE002 | SENSOR 60 B | 85 | GXOS062 | Zástrčka ZA | 93 |
| GXZK009 | MINI 4U 15W E14 | 68 | GKSE001 | SENSOR 60 W | 85 | GXOS064 | Zástrčka ZA IP44 | 94 |
| GXZK013 | MINI 4U 15W E27 | 68 | GKSE004 | SENSOR 70 B | 85 | GXOS063 | Zástrčka ZA | 94 |
| GXZK014 | MINI 4U 20W E27 | 68 | GKSE003 | SENSOR 70 W | 85 | GXOS065 | Zástrčka ZS IP44 | 94 |
| GXZK015 | MINI 4U 23W E27 | 68 | GKSE006 | SENSOR 80 B | 86 | | | |

LED ZDROJE A SVIETIDIA





LED MCOB E27

Úsporná žiarovka LED MCOB

- nová technológia MCOB (Multi Chips On Board)
- výrazne nižšia spotreba energie ako u bežných žiaroviek
- veľkoplošný svetelný zdroj
- vysoká účinnosť svetelného zdroja (90-100 lm/W)

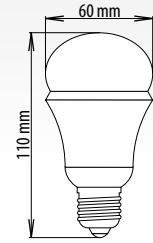

DKC

LED MCOB E27 5W - CW

GXLZ040

8592660104263

studená biela

5

6000-6500K

480

80

18,37 €

LED MCOB E27 5W - WW

GXLZ041

8592660104300

teplá biela

5

2700-3300K

440

75

18,37 €



LED24 SMD 5050 GU10

Svetelný zdroj SMD LED

- životnosť 40 000 hodín
- LED čip 5050 SMD

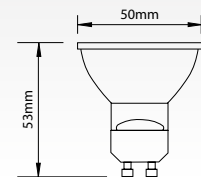

DKC

LED24 SMD 5050 GU10 4W - CW

GXLZ044

8592660104584

studená biela

4

6500-7000K

320

80

14,75 €

LED24 SMD 5050 GU10 4W - WW

GXLZ045

8592660104591

teplá biela

4

3000-3500K

320

75

14,75 €



HALOGEN 30W

LED60 SMD GU10

Svetelný zdroj SMD LED
- životnosť 40 000 hodín

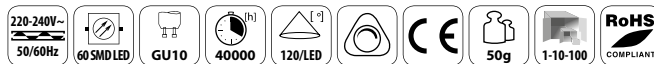
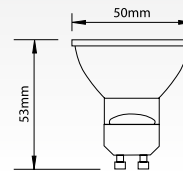

DKC

LED60 SMD GU10 4W - CW

GXLZ032

8592660104072

studená biela

4

6500-7000K

280

80

12,65 €

LED60 SMD GU10 4W - WW

GXLZ031

8592660104140

teplá biela

4

3000-3500K

280

75

12,65 €



HALOGEN 25W

LED48 SMD GU10

Svetelný zdroj SMD LED
- životnosť 40 000 hodín

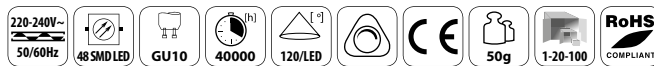
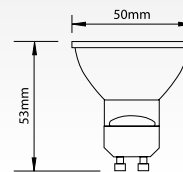

DKC

LED48 SMD GU10 3,5W - CW

GXLZ001

8592660103006

studená biela

3,5

6500-7000K

225

80

11,50 €

LED48 SMD GU10 3,5W - WW

GXLZ002

8592660103013

teplá biela

3,5

3000-3500K

225

75

11,50 €

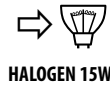

LED30 SMD GU10

Svetelný zdroj SMD LED
- životnosť 40 000 hodín

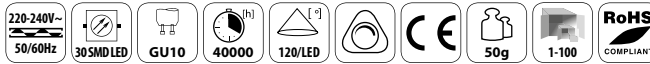
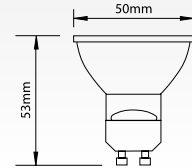

DKC

LED30 SMD GU10 2W - CW

GXLZ003

8592660103020

studená biela

2

6500-7000K

120

80

7,69 €

LED30 SMD GU10 2W - WW

GXLZ004

8592660103037

teplá biela

2

3000-3500K

120

75

7,69 €



LED60 SMD JCDR*

Svetelný zdroj SMD LED
- životnosť 40 000 hodín

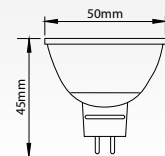

DKC

LED60 SMD JCDR 3W - CW

GXLZ042

8592660104362

studená biela

3

6500-7000K

280

80

-

LED60 SMD JCDR 3W - WW

GXLZ043

8592660104379

teplá biela

3

3000-3500K

280

75

-

* tovar dostupný len v Polsku



HALOGEN 35W

LED80 SMD E27

Svetelný zdroj SMD LED

- životnosť 40 000 hodín

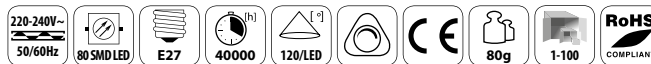
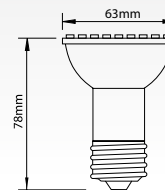

| | | | | | | | | DKC |
|------------------------------|---------|---------------|---------------|---|------------|-----|----|---------|
| LED80 SMD E27 5W - CW | GXLZ049 | 8592660104706 | studená biela | 5 | 6500-7000K | 350 | 80 | 17,62 € |
| LED80 SMD E27 5W - WW | GXLZ048 | 8592660104690 | teplá biela | 5 | 3000-3500K | 350 | 75 | 17,62 € |



HALOGEN 30W

LED60 SMD E27

Svetelný zdroj SMD LED

- životnosť 40 000 hodín

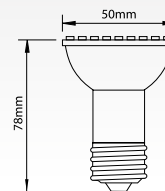

| | | | | | | | | DKC |
|------------------------------|---------|---------------|---------------|---|------------|-----|----|---------|
| LED60 SMD E27 4W - CW | GXLZ034 | 8592660104157 | studená biela | 4 | 6500-7000K | 280 | 80 | 12,65 € |
| LED60 SMD E27 4W - WW | GXLZ033 | 8592660104089 | teplá biela | 4 | 3000-3500K | 280 | 75 | 12,65 € |



HALOGEN 33W

LED24 SMD 5050 E14

Svetelný zdroj SMD LED

- životnosť 40 000 hodín
- LED čip 5050 SMD

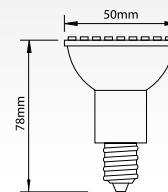

DKC

LED24 SMD 5050 E14 4W - CW

GXLZ051

8592660104720

studená biela

4

6500-7000K

320

80

14,75 €

LED24 SMD 5050 E14 4W - WW

GXLZ050

8592660104713

teplá biela

4

3000-3500K

320

75

14,75 €



HALOGEN 30W

LED60 SMD E14

Svetelný zdroj SMD LED

- životnosť 40 000 hodín

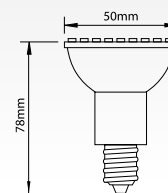

DKC

LED60 SMD E14 4W - CW

GXLZ038

8592660104225

studená biela

4

6500-7000K

280

80

13,52 €

LED60 SMD E14 4W - WW

GXLZ037

8592660104218

teplá biela

4

3000-3500K

280

75

13,52 €



HALOGEN 30W

LED60 SMD MR16

Svetelný zdroj SMD LED
- životnosť 40 000 hodín

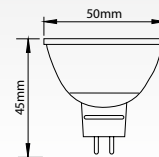

| | | | | | | | | | DKC |
|-------------------------------|---------|---------------|---------------|---|------------|-----|----|--|---------|
| LED60 SMD MR16 4W - CW | GXLZ030 | 8592660104133 | studená biela | 4 | 6500-7000K | 280 | 80 | | 12,65 € |
| LED60 SMD MR16 4W - WW | GXLZ029 | 8592660104065 | teplá biela | 4 | 3000-3500K | 280 | 75 | | 12,65 € |



HALOGEN 25W

LED48 SMD MR16

Svetelný zdroj SMD LED
životnosť: 40 000 hodín

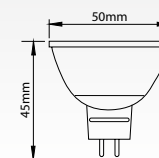

| | | | | | | | | | DKC |
|---------------------------------|---------|---------------|---------------|-----|------------|-----|----|--|---------|
| LED48 SMD MR16 3,5W - CW | GXLZ005 | 8592660103044 | studená biela | 3,5 | 6500-7000K | 225 | 80 | | 11,50 € |
| LED48 SMD MR16 3,5W - WW | GXLZ006 | 8592660103051 | teplá biela | 3,5 | 3000-3500K | 225 | 75 | | 11,50 € |



LED30 SMD MR16

Svetelný zdroj SMD LED

životnosť: 40 000 hodín

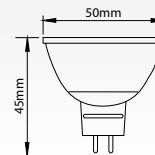

DKC

LED30 SMD MR16 2W - CW

GXLZ007

8592660103068

studená biela

2

6500-7000K

120

80

5,77 €

LED30 SMD MR16 2W - WW

GXLZ008

8592660103075

teplá biela

2

3000-3500K

120

75

5,77 €



LED9 SMD 5050 MR11

Svetelný zdroj SMD LED

- životnosť 40 000 hodín

- LED čip 5050 SMD

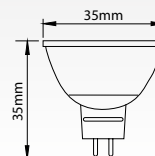

DKC

LED9 SMD 5050 MR11 2W - WW

GXLZ036

8592660104119

teplá biela

2

3000-3500K

110

75

7,30 €



LED13 SMD 5050 JC

Svetelný zdroj SMD LED

- životnosť: 40 000 hodín
- LED čip 5050 SMD

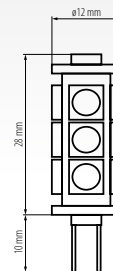
DKC
LED13 SMD 5050 JC 2W - CW

GXLZ047

8592660104676

studená biela

2

6500-7000K

160

80

9,84 €

LED13 SMD 5050 JC 2W - WW

GXLZ053

8592660104744

teplá biela

2

3000-3500K

160

75

9,84 €



LED18 SMD JC

Svetelný zdroj SMD LED

- životnosť 40 000 hodín

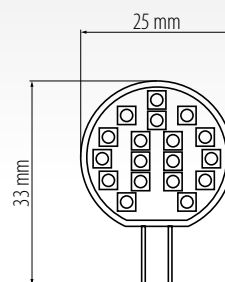
DKC
LED 18 SMD JC 1W - CW

GXLZ052

8592660104737

studená biela

1

6500-7000K

60

80

6,94 €

LED 18 SMD JC 1W - WW

GXLZ046

8592660104683

teplá biela

1

3000-3500K

60

75

6,94 €



HALOGEN 20W

LED60 GU10

Svetelný zdroj LED
- životnosť 30 000 hodin

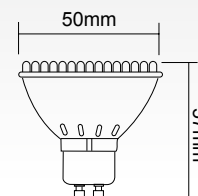

DKC

LED60 GU10 3W - CW

GXLZ021

8592660103211

studená biela

3

6000-7000K

170

70

9,05 €

LED60 GU10 3W - WW

GXLZ022

8592660103228

teplá biela

3

2700-3200K

170

60

9,05 €



HALOGEN 16W

LED48 GU10

Svetelný zdroj LED
- životnosť 30 000 hodin

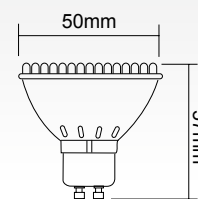

DKC

LED48 GU10 2,4W - CW

GXLZ019

8592660103198

studená biela

2,4

6000-7000K

130

70

6,58 €

LED48 GU10 2,4W - WW

GXLZ020

8592660103204

teplá biela

2,4

2700-3200K

130

60

6,58 €



HALOGEN 12W

LED30 GU10

Svetelný zdroj LED
- životnosť 30 000 hodín

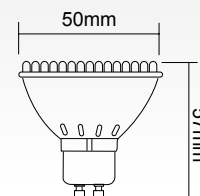

| | | | | | | | | DKC |
|-----------------------------|---------|---------------|---------------|-----|------------|----|----|--------|
| LED30 GU10 1,5W - CW | GXLZ017 | 8592660103174 | studená biela | 1,5 | 6000-7000K | 85 | 70 | 3,31 € |
| LED30 GU10 1,5W - WW | GXLZ018 | 8592660103181 | teplá biela | 1,5 | 2700-3200K | 85 | 60 | 3,31 € |



HALOGEN 20W

LED60 MR16

Svetelný zdroj LED
životnosť: 30 000 hodín

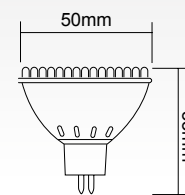

| | | | | | | | | DKC |
|---------------------------|---------|---------------|---------------|---|------------|-----|----|--------|
| LED60 MR16 3W - CW | GXLZ027 | 8592660103273 | studená biela | 3 | 6000-7000K | 170 | 70 | 8,23 € |
| LED60 MR16 3W - WW | GXLZ028 | 8592660103280 | teplá biela | 3 | 2700-3200K | 170 | 60 | 8,23 € |



HALOGEN 16W

LED48 MR16

Svetelný zdroj LED

životnosť: 30 000 hodín

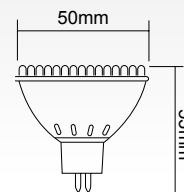

DKC

LED48 MR16 2,4W - CW

GXLZ025

8592660103259

studená biela

2,4

6000-7000K

130

70

6,20 €

LED48 MR16 2,4W - WW

GXLZ026

8592660103266

teplá biela

2,4

2700-3200K

130

60

6,20 €



HALOGEN 12W

LED30 MR16

Svetelný zdroj LED

životnosť: 30 000 hodín

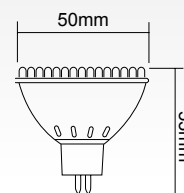

DKC

LED30 MR16 1,5W - CW

GXLZ023

8592660103235

studená biela

1,5

6000-7000K

85

70

3,31 €

LED30 MR16 1,5W - WW

GXLZ024

8592660103242

teplá biela

1,5

2700-3200K

85

60

3,31 €



HALOGEN 23W

LED POWER GU10 3x1W

Svetelný zdroj LED

životnosť: 40 000 hodín

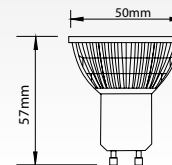

| | | | | | | | | | DKC |
|---------------------------------|---------|---------------|---------------|---|------------|-----|----|--------|------------|
| LED POWER GU10 3x1W - CW | GXLZ009 | 8592660103082 | studená biela | 3 | 6000-6500K | 200 | 80 | 6,50 € | |
| LED POWER GU10 3x1W - WW | GXLZ010 | 8592660103099 | teplá biela | 3 | 2700-3200K | 190 | 75 | 6,50 € | |



HALOGEN 15W

LED POWER GU10 1x3W

Svetelný zdroj LED

životnosť: 40 000 hodín

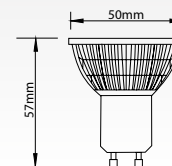

| | | | | | | | | | DKC |
|---------------------------------|---------|---------------|---------------|---|------------|-----|----|--------|------------|
| LED POWER GU10 1x3W - CW | GXLZ011 | 8592660103105 | studená biela | 3 | 6000-6500K | 135 | 80 | 4,90 € | |
| LED POWER GU10 1x3W - WW | GXLZ012 | 8592660103129 | teplá biela | 3 | 2700-3200K | 120 | 75 | 4,90 € | |



HALOGEN 23W

LED POWER MR16 3x1W

Svetelný zdroj LED

životnosť: 40 000 hodín

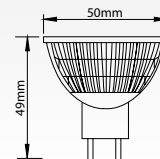

DKC

LED POWER MR16 3x1W - CW

GXLZ013

8592660103136

studená biela

3

6000-6500K

200

80

4,90 €

LED POWER MR16 3x1W - WW

GXLZ014

8592660103143

teplá biela

3

2700-3200K

190

75

4,90 €



HALOGEN 15W

LED POWER MR16 1x3W

Svetelný zdroj LED

životnosť: 40 000 hodín

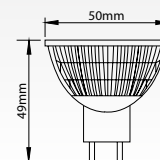

DKC

LED POWER MR16 1x3W - CW

GXLZ015

8592660103150

studená biela

3

6000-6500K

135

85

4,90 €

LED POWER MR16 1x3W - WW

GXLZ016

8592660103167

teplá biela

3

2700-3200K

120

75

4,90 €

Príslušenstvo



Popis

DKC

Objímka LH - GZ10

GX0S043

8592660103297

Keramická objímka 220-240V GZ10

0,35 €

Objímka LH - GX5,3

GX0S045

8592660103310

Keramická objímka 12V GX5,3

0,23 €



LED STRIP IP65

Lineárne moduly LED

Cena za pás s dĺžkou 5 metrov

Možnosť delenia na časti (50 mm = 3xLED)

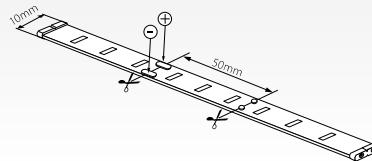

| | | | | | | DKC |
|----------------------|---------|---------------|---------------|----|------------|---------|
| LED STRIP 5m IP65 RE | GXLS011 | 8592660102887 | červená | 24 | - | 44,80 € |
| LED STRIP 5m IP65 YE | GXLS012 | 8592660102894 | žltá | 24 | - | 44,80 € |
| LED STRIP 5m IP65 OR | GXLS013 | 8592660102900 | oranžová | 24 | - | 44,80 € |
| LED STRIP 5m IP65 BL | GXLS014 | 8592660102917 | modrá | 24 | - | 44,80 € |
| LED STRIP 5m IP65 GN | GXLS015 | 8592660102924 | zelená | 24 | - | 44,80 € |
| LED STRIP 5m IP65 CW | GXLS016 | 8592660102931 | teplá biela | 24 | 5000-6000K | 44,80 € |
| LED STRIP 5m IP65 WW | GXLS017 | 8592660102948 | studená biela | 24 | 2700-3500K | 44,80 € |

LED STRIP

Lineárne moduly LED

Cena za pás s dĺžkou 5 metrov

Možnosť delenia na časti (50 mm = 3xLED)

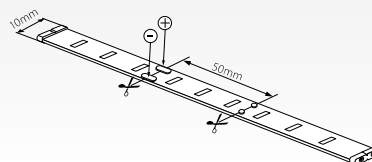

| | | | | | | DKC |
|-----------------|---------|---------------|---------------|----|------------|---------|
| LED STRIP 5m RE | GXLS004 | 8592660102818 | červená | 24 | - | 36,64 € |
| LED STRIP 5m YE | GXLS005 | 8592660102825 | žltá | 24 | - | 36,64 € |
| LED STRIP 5m OR | GXLS006 | 8592660102832 | oranžová | 24 | - | 36,64 € |
| LED STRIP 5m BL | GXLS007 | 8592660102849 | modrá | 24 | - | 36,64 € |
| LED STRIP 5m GN | GXLS008 | 8592660102856 | zelená | 24 | - | 36,64 € |
| LED STRIP 5m CW | GXLS009 | 8592660102863 | teplá biela | 24 | 5000-6000K | 36,64 € |
| LED STRIP 5m WW | GXLS010 | 8592660102870 | studená biela | 24 | 2700-3500K | 36,64 € |

Príslušenstvo

| | | | Popis | DKC |
|---------------|---------|---------------|------------------------------|---------|
| DRIVER LED3x1 | GXLD001 | 8592660103525 | Elektronický driver LED 1x3W | 9,96 € |
| DRIVER LED30 | GXLD002 | 8592660103532 | Elektronický driver LED 30W | 19,19 € |



TOMI LED

Reflektor LED so senzorom pohybu

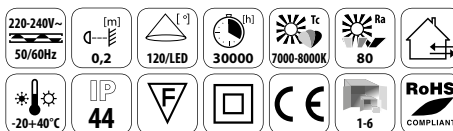
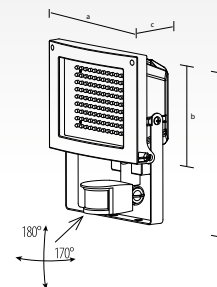

| | | | | | | | a [mm] | b [mm] | c [mm] | d [mm] | | DKC |
|-----------------------|---------|---------------|---------------|---|-----|-----|--------|--------|--------|--------|---------|-----|
| TOMI LED 60 B | GXLS001 | 8592660100708 | studená biela | 5 | 215 | 225 | 140 | 125 | 215 | 0,95kg | 20,63 € | |
| TOMI LED 117 B | GXLS002 | 8592660100715 | studená biela | 9 | 410 | 225 | 170 | 110 | 230 | 1,15kg | 36,30 € | |



HALO LED

Reflektor LED

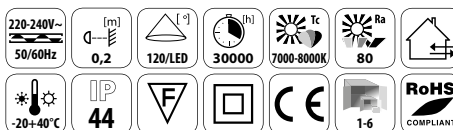
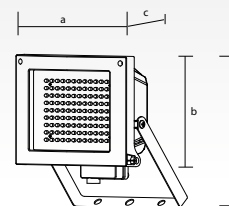

| | | | | | | | a [mm] | b [mm] | c [mm] | d [mm] | | DKC |
|-----------------------|---------|---------------|---------------|---|-----|-----|--------|--------|--------|---------|---------|-----|
| HALO LED 117 B | GXLS003 | 8592660101361 | studená biela | 9 | 410 | 225 | 170 | 110 | 230 | 0,95 kg | 31,14 € | |



HALO MCOB

Energeticky úsporný reflektor LED MCOB



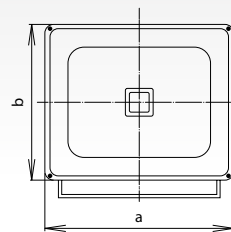



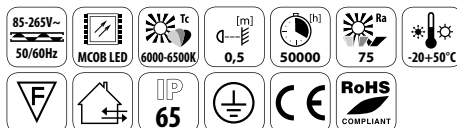

- výrazne nižšia spotreba energie
ako u bežných halogénových reflektorov



➔ HALOGEN F-class

10W ⇔ 100W
30W ⇔ 250W
50W ⇔ 400W



|  |  |  |  |  |  | a [mm] | b [mm] |  |  | DKC |
|---|---|---|---|---|---|--------|--------|---|---|----------|
| HALO MCOB 10W | GXLS025 | 8592660104232 | studená biela | 10 | 1000 | 115 | 86 | 0,55kg | 1-20 | 40,73 € |
| HALO MCOB 30W | GXLS026 | 8592660104249 | studená biela | 30 | 3000 | 225 | 185 | 2,25kg | 1-2 | 121,11 € |
| HALO MCOB 50W | GXLS027 | 8592660104256 | studená biela | 50 | 5000 | 290 | 236 | 3,15kg | 1-2 | 222,65 € |



DUST metal

Svietidlo prachotesné

teleso svietidla: hliník

difuzor: sklo

- elektronický predradník

- vhodné do priestorov s vysokým zatažením

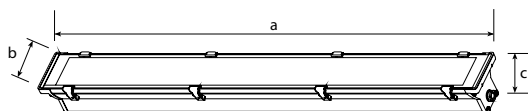
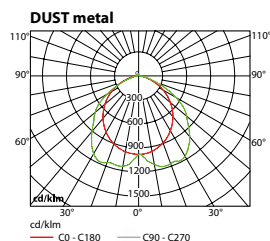
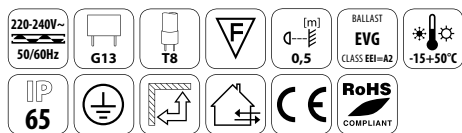

| | | | | | | | | | | |
|-------------------------|---------|---------------|------|--------|--------|--------|--------|---------|-----|------------|
| | | | | | a [mm] | b [mm] | c [mm] | | | DKC |
| DUST metal 2x36W | GXWP004 | 8592660101026 | šedá | 2 x 36 | 1285 | 150 | 95 | 5,45 kg | 1-3 | 58,40 € |

Príslušenstvo k DUST metal

| | | | DKC |
|--------------------------------------|---------|---------------|------------|
| Difuzor - DUST metal 2x36W | GXOS014 | 8592660101545 | 9,19 € |
| Predradník - EVG DP 2x36W | GXOS003 | 8592660101460 | 14,58 € |
| Klip nerez - DUST metal 2x36W | GXOS017 | 8592660101576 | 0,96 € |
| Priechodka - DUST metal 2x36W | GXOS013 | 8592660101538 | 2,15 € |
| Držiak - DUST metal 2x36W | GXOS016 | 8592660101569 | 0,35 € |

DUST premium

Svietidlo prachotesné

teleso svietidla: polykarbonát
difuzor: polykarbonát
- elektronický predradník

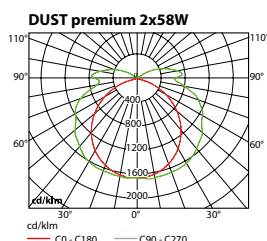
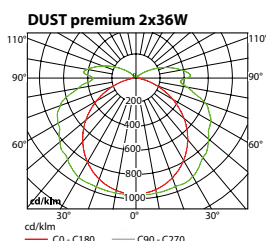
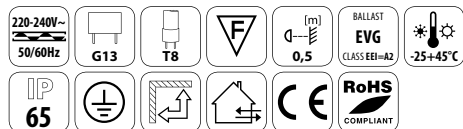

| DUST premium 2x36W | GXWP001 | 8592660100999 | šedá | 2 x 36 | 1265 | 155 | 105 | 2,65 kg | 1-3 | 33,00 € |
|--------------------|---------|---------------|------|--------|------|-----|-----|---------|-----|---------|
| DUST premium 2x58W | GXWP002 | 8592660101002 | šedá | 2 x 58 | 1565 | 155 | 105 | 3,35 kg | 1-4 | 39,60 € |

Príslušenstvo k DUST premium



| Difuzor - DUST premium 2x36W | GXOS002 | 8592660101453 | 11,50 € |
|------------------------------|---------|---------------|---------|
| Difuzor - DUST premium 2x58W | GXOS008 | 8592660101514 | 15,35 € |
| Predradník - EVG DP 2x36W | GXOS003 | 8592660101460 | 14,58 € |
| Predradník - EVG DP 2x58W | GXOS009 | 8592660101521 | 15,35 € |
| Klip PC - DUST premium | GXOS005 | 8592660101484 | 0,58 € |
| Klip nerez - DUST premium | GXOS006 | 8592660101491 | 0,81 € |
| Priechodka - DUST premium | GXOS001 | 8592660101446 | 0,19 € |
| Držiak - DUST premium | GXOS004 | 8592660101477 | 0,31 € |

DUST EVG PC

Svietidlo prachotesné

teleso svietidla: ABS
difuzor: polykarbonát
- elektronický predradník

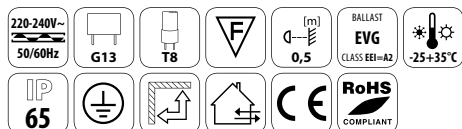
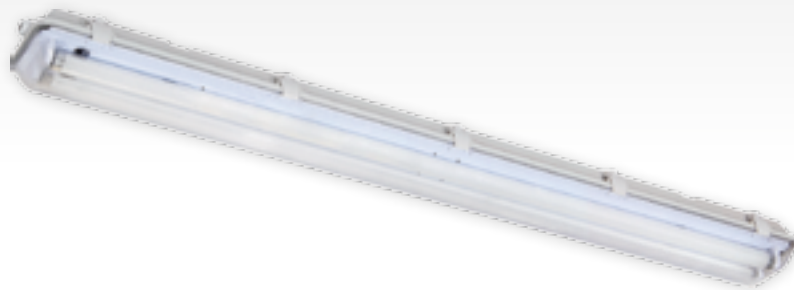

DUST EVG PC 2x36W

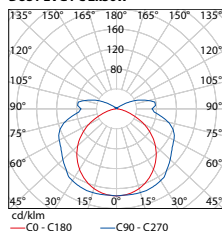

DUST EVG PC 2x58W

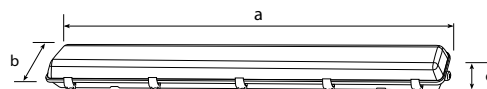
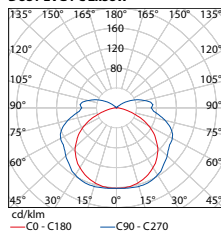

DUST EVG PC 2x36W



GXWP005



8592660102467



šedá



2x36



1265



140



95



1,90 kg



1-6

DKC

22,40 €



DUST EVG PC 2x58W



GXWP006



8592660102474



šedá



2x58



1575



140



95



2,50 kg



1-4

DKC

28,84 €

Príslušenstvo k DUST EVG PC



Difuzor - DUST PC 2x36W



GXOS021



8592660102597

DKC

6,00 €

Difuzor - DUST PC 2x58W

GXOS023

8592660102610

8,42 €

Predradník - EVG 2x36W

GXOS030

8592660102689

11,12 €

Predradník - EVG 2x58W

GXOS031

8592660102696

13,81 €

PC klip k DUST EVG,VVG

GXOS036

8592660102740

0,54 €

Klip nerez - DUST EVG,VVG

GXOS037

8592660102757

0,62 €

Priechodka - DUST EVG,VVG

GXOS034

8592660102726

0,35 €

Držiak - DUST EVG,VVG

GXOS035

8592660102733

0,35 €

DUST VVG PC

Svietidlo prachotesné

teleso svietidla: ABS

difuzor: polykarbonát

- indukčný predradník

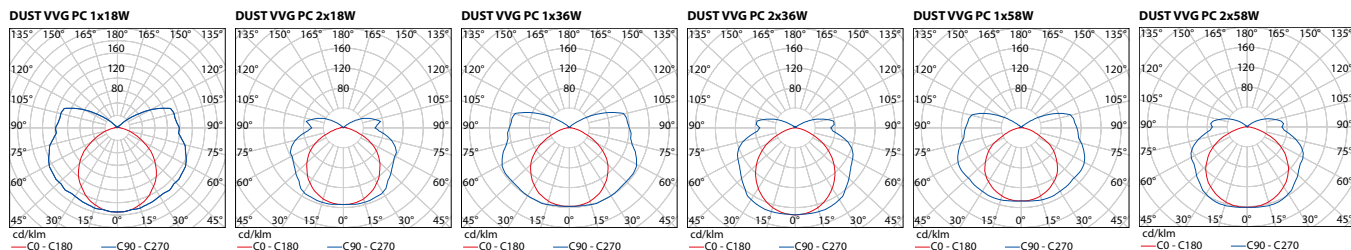
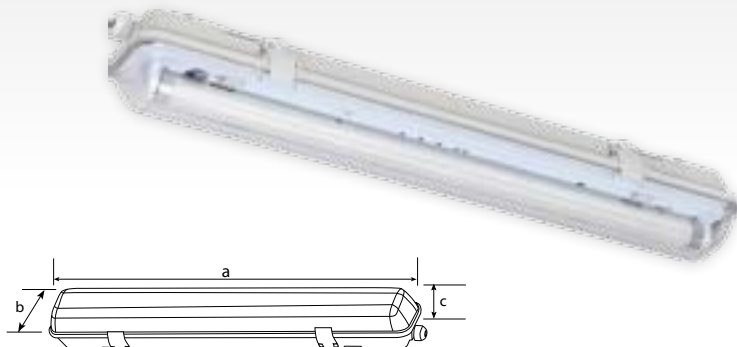
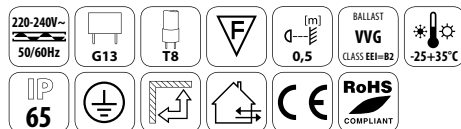

| | | | | | a [mm] | b [mm] | c [mm] | | | DKC |
|--------------------------|---------|---------------|------|------|--------|--------|--------|---------|------|---------|
| DUST VVG PC 1x18W | GXWP007 | 8592660102405 | šedá | 18 | 660 | 100 | 95 | 1,30 kg | 1-10 | 9,80 € |
| DUST VVG PC 2x18W | GXWP008 | 8592660102412 | šedá | 2x18 | 660 | 135 | 95 | 1,45 kg | 1-8 | 15,20 € |
| DUST VVG PC 1x36W | GXWP009 | 8592660102429 | šedá | 36 | 1265 | 100 | 95 | 1,75 kg | 1-6 | 13,20 € |
| DUST VVG PC 2x36W | GXWP010 | 8592660102436 | šedá | 2x36 | 1265 | 140 | 95 | 2,60 kg | 1-6 | 18,80 € |
| DUST VVG PC 1x58W | GXWP011 | 8592660102443 | šedá | 58 | 1565 | 100 | 95 | 2,45 kg | 1-6 | 20,00 € |
| DUST VVG PC 2x58W | GXWP012 | 8592660102450 | šedá | 2x58 | 1565 | 140 | 95 | 3,75 kg | 1-4 | 28,46 € |

Príslušenstvo k DUST VVG PC

| | | | DKC |
|-----------------------------------|---------|---------------|--------|
| Difuzor - DUST PC 1x18W | GXOS018 | 8592660102566 | 2,65 € |
| Difuzor - DUST PC 2x18W | GXOS019 | 8592660102573 | 3,62 € |
| Difuzor - DUST PC 1x36W | GXOS020 | 8592660102580 | 4,96 € |
| Difuzor - DUST PC 2x36W | GXOS021 | 8592660102597 | 6,00 € |
| Difuzor - DUST PC 1x58W | GXOS022 | 8592660102603 | 6,50 € |
| Difuzor - DUST PC 2x58W | GXOS023 | 8592660102610 | 8,42 € |
| Predradník - VVG 18W | GXOS052 | 8592660103365 | 4,96 € |
| Predradník - VVG 36W | GXOS032 | 8592660102702 | 5,35 € |
| Predradník - VVG 58W | GXOS033 | 8592660102719 | 7,65 € |
| PC klip k DUST EVG, VVG | GXOS036 | 8592660102740 | 0,54 € |
| Klip nerez - DUST EVG, VVG | GXOS037 | 8592660102757 | 0,62 € |
| Priechodka - DUST EVG, VVG | GXOS034 | 8592660102726 | 0,35 € |
| Držiak - DUST EVG, VVG | GXOS035 | 8592660102733 | 0,35 € |

DUST EVG PS

Svietidlo prachotesné

teleso svietidla: ABS
difuzor: polystyren
- elektronický predradník

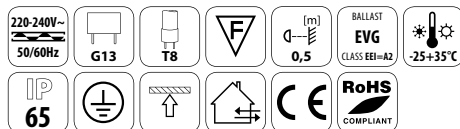
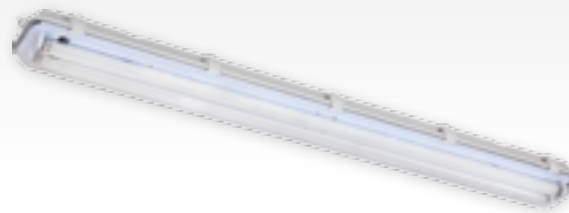

DUST EVG PS 2x36W

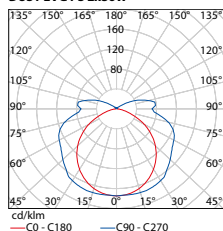

DUST EVG PS 2x58W

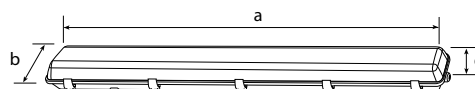
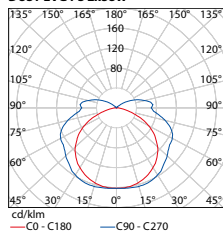

| | | | | | a [mm] | b [mm] | c [mm] | | | DKC |
|-------------------|---------|---------------|------|------|--------|--------|--------|---------|-----|---------|
| DUST EVG PS 2x36W | GXWP013 | 8592660102481 | šedá | 2x36 | 1265 | 140 | 95 | 1,90 kg | 1-6 | 20,40 € |
| DUST EVG PS 2x58W | GXWP014 | 8592660102498 | šedá | 2x58 | 1575 | 140 | 95 | 2,50 kg | 1-4 | 27,60 € |

Príslušenstvo k DUST EVG PS

| | | | DKC |
|---------------------------|---------|---------------|---------|
| Difuzor - DUST PS 2x36W | GXOS027 | 8592660102658 | 3,81 € |
| Difuzor - DUST PS 2x58W | GXOS029 | 8592660102672 | 5,35 € |
| Predradník - EVG 2x36W | GXOS030 | 8592660102689 | 11,12 € |
| Predradník - EVG 2x58W | GXOS031 | 8592660102696 | 13,81 € |
| PC klip k DUST EVG,VVG | GXOS036 | 8592660102740 | 0,54 € |
| Klip nerez - DUST EVG,VVG | GXOS037 | 8592660102757 | 0,62 € |
| Priechodka - DUST EVG,VVG | GXOS034 | 8592660102726 | 0,35 € |
| Držiak - DUST EVG,VVG | GXOS035 | 8592660102733 | 0,35 € |

DUST VVG PS

Svietidlo prachotesné

teleso svietidla: ABS

difuzor: polystyren

- indukčný predradník

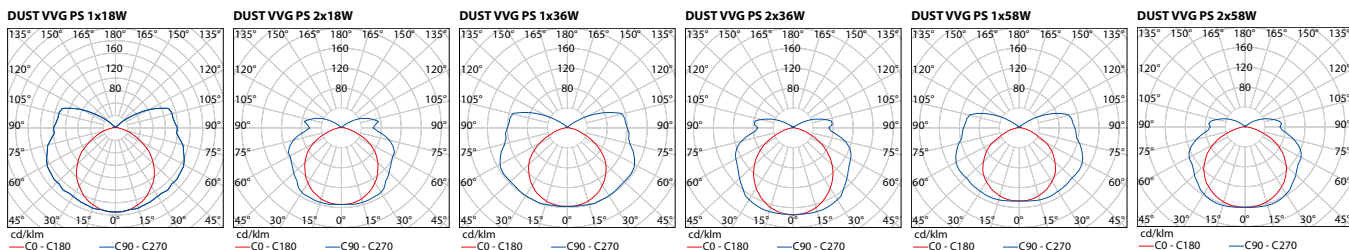
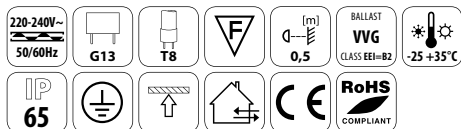

| | | | | | a [mm] | b [mm] | c [mm] | | | DKC |
|--------------------------|---------|---------------|------|------|--------|--------|--------|---------|------|---------|
| DUST VVG PS 1x18W | GXWP015 | 8592660102504 | šedá | 18 | 660 | 100 | 95 | 1,30 kg | 1-10 | 9,24 € |
| DUST VVG PS 2x18W | GXWP016 | 8592660102511 | šedá | 2x18 | 660 | 135 | 95 | 1,45 kg | 1-8 | 14,60 € |
| DUST VVG PS 1x36W | GXWP017 | 8592660102528 | šedá | 36 | 1265 | 100 | 95 | 1,75 kg | 1-6 | 12,60 € |
| DUST VVG PS 2x36W | GXWP018 | 8592660102535 | šedá | 2x36 | 1265 | 140 | 95 | 2,60 kg | 1-6 | 16,80 € |
| DUST VVG PS 1x58W | GXWP019 | 8592660102542 | šedá | 58 | 1565 | 100 | 95 | 2,45 kg | 1-6 | 18,00 € |
| DUST VVG PS 2x58W | GXWP020 | 8592660102559 | šedá | 2x58 | 1565 | 140 | 95 | 3,75 kg | 1-4 | 27,20 € |

Príslušenstvo k DUST VVG PC

| | | | DKC |
|-----------------------------------|---------|---------------|--------|
| Difuzor - DUST PS 1x18W | GXOS024 | 8592660102627 | 1,89 € |
| Difuzor - DUST PS 2x18W | GXOS025 | 8592660102634 | 2,27 € |
| Difuzor - DUST PS 1x36W | GXOS026 | 8592660102641 | 3,12 € |
| Difuzor - DUST PS 2x36W | GXOS027 | 8592660102658 | 3,81 € |
| Difuzor - DUST PS 1x58W | GXOS028 | 8592660102665 | 3,81 € |
| Difuzor - DUST PS 2x58W | GXOS029 | 8592660102672 | 5,35 € |
| Predradník - VVG 18W | GXOS052 | 8592660103365 | 4,96 € |
| Predradník - VVG 36W | GXOS032 | 8592660102702 | 5,35 € |
| Predradník - VVG 58W | GXOS033 | 8592660102719 | 7,65 € |
| PC klip k DUST EVG, VVG | GXOS036 | 8592660102740 | 0,54 € |
| Klip nerez - DUST EVG, VVG | GXOS037 | 8592660102757 | 0,62 € |
| Priechodka - DUST EVG, VVG | GXOS034 | 8592660102726 | 0,35 € |
| Držiak - DUST EVG, VVG | GXOS035 | 8592660102733 | 0,35 € |

UGO

Žiarivkové svietidlo

- možnosť doplnenia o reflektor.
- indukčný predradník

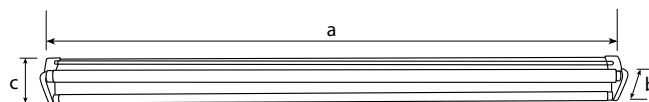
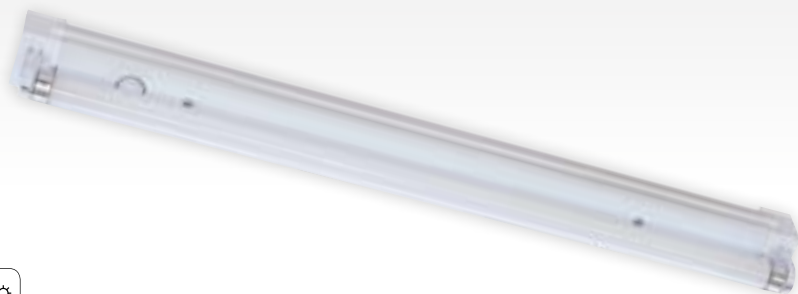
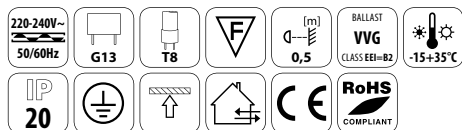

| | | | | | a [mm] | b [mm] | c [mm] | | | DKC |
|------------------|---------|---------------|-------|------|--------|--------|--------|---------|------|---------|
| UGO 1x18W | GXIK006 | 8592660104058 | biela | 18 | 620 | 55 | 80 | 0,85 kg | 1-10 | 9,84 € |
| UGO 2x18W | GXIK003 | 8592660101392 | biela | 2x18 | 620 | 100 | 80 | 0,90 kg | 1-10 | 10,35 € |
| UGO 1x36W | GXIK001 | 8592660101378 | biela | 36 | 1230 | 55 | 80 | 1,10 kg | 1-10 | 9,58 € |
| UGO 2x36W | GXIK004 | 8592660101408 | biela | 2x36 | 1230 | 100 | 80 | 1,80 kg | 1-10 | 16,89 € |
| UGO 1x58W | GXIK002 | 8592660101385 | biela | 58 | 1535 | 55 | 80 | 1,70 kg | 1-10 | 14,96 € |
| UGO 2x58W | GXIK005 | 8592660101415 | biela | 2x58 | 1530 | 100 | 80 | 2,60 kg | 1-10 | 23,81 € |

Reflektor UGO

Samostatný reflektor pre svietidlá UGO. Pri požiadavke svietidla UGO s reflektorom je potrebné objednať svietidlo a reflektor.



| | | | DKC |
|------------------------------|---------|---------------|--------|
| Reflector - UGO 1x36W | GXOS010 | 8592660102795 | 3,04 € |
| Reflector - UGO 2x36W | GXOS011 | 8592660102801 | 3,81 € |

MIRA

Žiarivkové svetidlo
- indukčný predradník

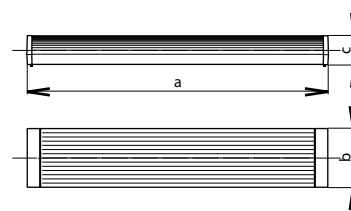
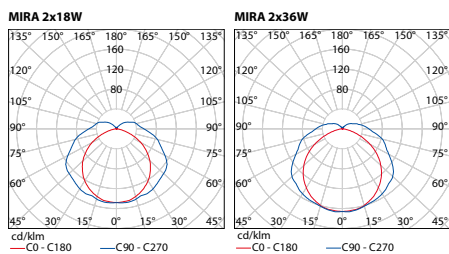
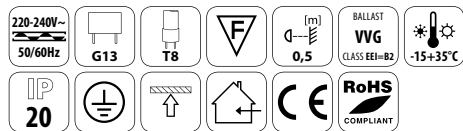

| | | | | | | | | | | | DKC |
|-------------------|--|--|---------------|-------------------|------|--------|--------|--------|---------|-----|------------|
| | | | EAN | | [W] | a [mm] | b [mm] | c [mm] | | | |
| MIRA 2x18W | | | 8592660104393 | biela/transparent | 2x18 | 640 | 152 | 64 | 1,15 kg | 1-8 | 17,62 € |
| MIRA 2x36W | | | 8592660104386 | biela/transparent | 2x36 | 1245 | 152 | 64 | 2,20 kg | 1-4 | 28,71 € |

GEMINI EVG

Svietidlo žiarivkové prisadené

teleso svietidla: oceľový plech
reflektor: elektrochemicky leštený hliník
predradník: elektronický

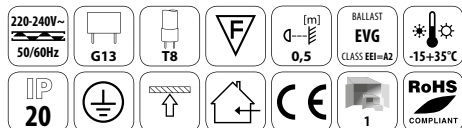



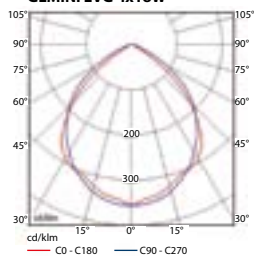

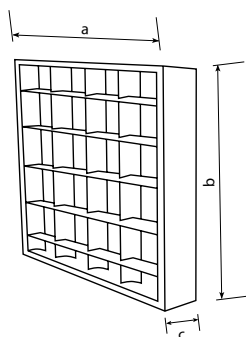
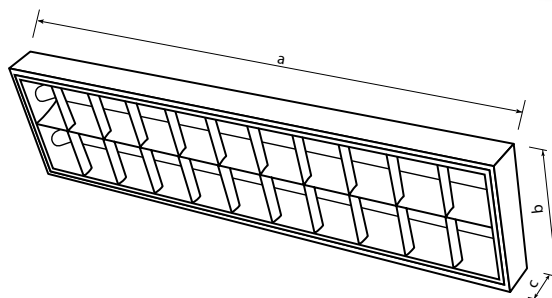
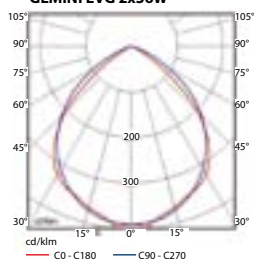

GEMINI EVG 4x18W



GEMINI EVG 2x36W



|  |  |  |  |  | a [mm] | b [mm] | c [mm] |  | DKC |
|---|---|---|---|---|--------|--------|--------|---|---------|
| GEMINI EVG 4x18W | GXRP001 | 8592660100791 | biela | 4x18 | 610 | 610 | 80 | 2,95 kg | 34,58 € |
| GEMINI EVG 2x36W | GXRP002 | 8592660100807 | biela | 2x36 | 1225 | 280 | 80 | 3,10 kg | 32,27 € |

GEMINI VVG

Svietidlo žiarivkové prisadené

teleso svietidla: ocelový plech
 reflektor: elektrochemicky leštený hliník
 predradník: indukčný

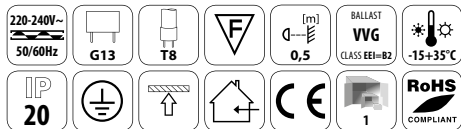

GEMINI VVG 4x18W

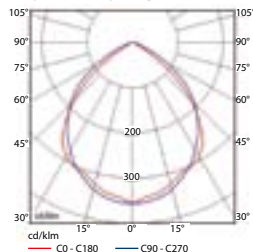

GEMINI VVG 2x36W

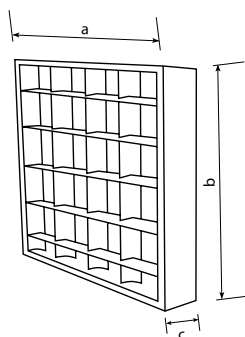
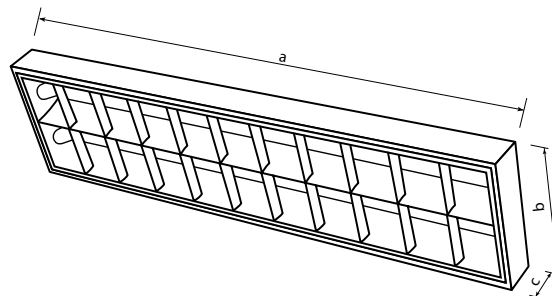
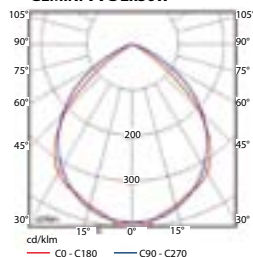

a [mm]

b [mm]

c [mm]



DKC

GEMINI VVG 4x18W

GXRP005

8592660104270

biela

4x18

610

610

80

3,85 kg

32,82 €

GEMINI VVG 2x36W

GXRP006

8592660104287

biela

2x36

1225

280

80

4,00 kg

30,35 €

ARIES EVG

Svietidlo žiarivkové vstavané

teleso svietidla: ocelový plech
reflektor: elektrochemicky leštený hliník
predradník: elektronický

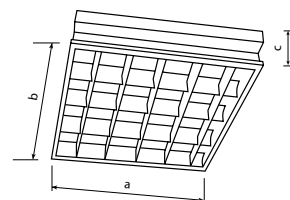
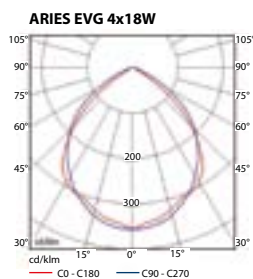
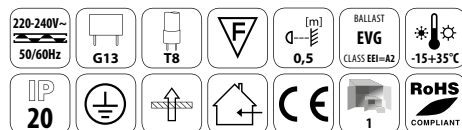

| | | | | | | | | | |
|-----------------|---------|---------------|-------|------|--------|--------|--------|---------|---------|
| | | | | | a [mm] | b [mm] | c [mm] | | DKC |
| ARIES EVG 4X18W | GXRV001 | 8592660100784 | biela | 4x18 | 595 | 595 | 80 | 3,10 kg | 30,73 € |

ARIES VVG

Svietidlo žiarivkové vstavané

teleso svietidla: ocelový plech
reflektor: elektrochemicky leštený hliník
predradník: indukčný

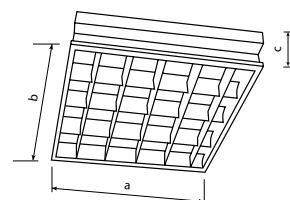
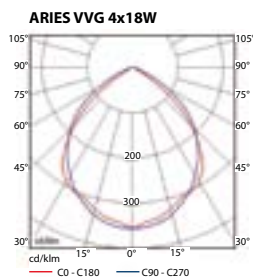
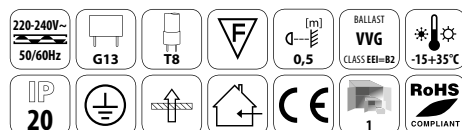

| | | | | | | | | | |
|-----------------|---------|---------------|-------|------|--------|--------|--------|---------|---------|
| | | | | | a [mm] | b [mm] | c [mm] | | DKC |
| ARIES VVG 4X18W | GXRV003 | 8592660104294 | biela | 4x18 | 595 | 595 | 80 | 3,90 kg | 29,00 € |

Príslušenstvo k ARIES

| | | | |
|--------------------------|---------|---------------|--------|
| | | | DKC |
| Montážna konzola k ARIES | GX0S007 | 8592660101507 | 0,35 € |

ORI EVG

Svietidlo žiarivkové prisadené
 teleso svietidla: ocelový plech
 reflektor: poniklovaný plech
 predradník: elektronický

| | | | | |
|--------------------------------|---------|----------|-------------------|--------------|
| 220-240V~ 50/60Hz | G13 | T8 | F | d [m] 0,5 |
| BALLAST EVG CLASS EEI=A2 | 15+35°C | IP 20 | RoHS COMPLIANT | |
| RoHS COMPLIANT | CE | 2 | | |

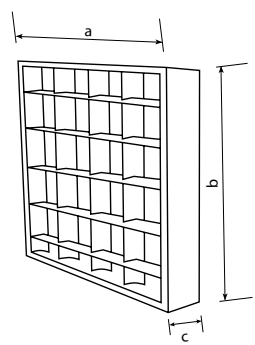
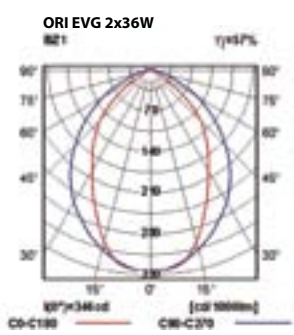
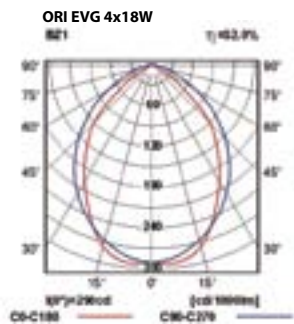
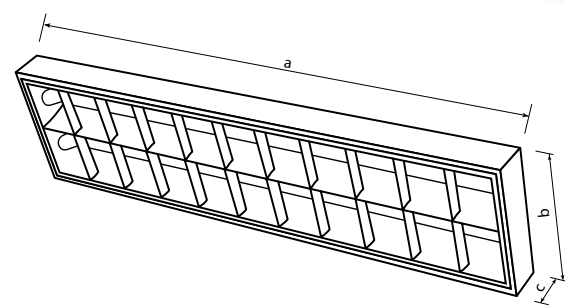

| | | | | | a [mm] | b [mm] | c [mm] | | DKC |
|----------------------|---------|---------------|-------|------|--------|--------|--------|---------|---------|
| ORI EVG 4x18W | GXRP007 | 8592660104799 | biela | 4x18 | 610 | 600 | 80 | 4,85 kg | 29,80 € |
| ORI EVG 2x36W | GXRP008 | 8592660104782 | biela | 2x36 | 1220 | 300 | 80 | 5,05 kg | 29,80 € |

ORI VVG

Svietidlo žiarivkové prisadené

teleso svietidla: ocelový plech
 reflektor: poniklovaný plech
 predradník: indukčný

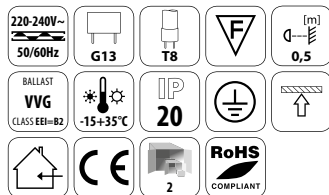

ORI VVG 4x18W

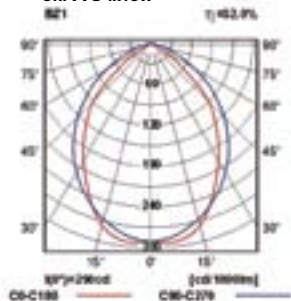

ORI VVG 2x36W

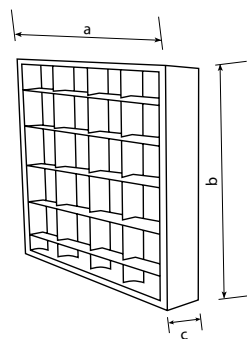
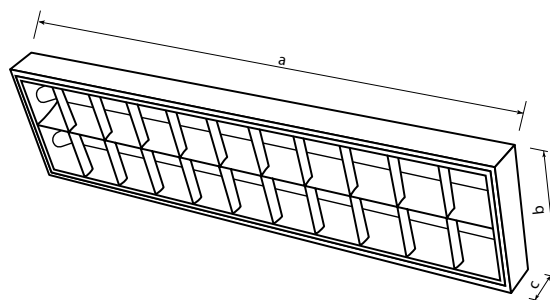
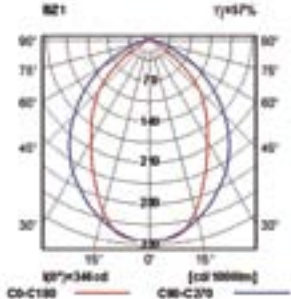

a [mm]

b [mm]

c [mm]



DKC

ORI VVG 4x18W

GXRP003

8592660102771

biela

4x18

610

600

80

4,00 kg

24,80 €

ORI VVG 2x36W

GXRP004

8592660102788

biela

2x36

1220

300

80

4,25 kg

24,80 €

TAU EVG

Svietidlo žiarivkové vstavané

teleso svietidla: ocelový plech
 reflektor: poniklovaný plech
 predradník: elektronický

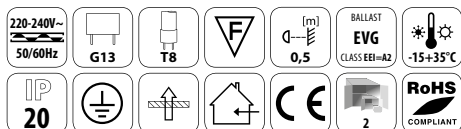

TAU EVG 4x18W

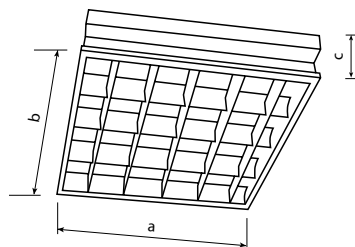
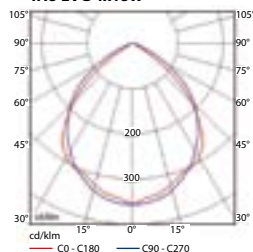

TAU EVG 4X18W



GXRV009



8592660104775



biela



4x18



600



600



80



3,00 kg

DKC

28,28 €

TAU VVG

Svietidlo žiarivkové vstavané

teleso svietidla: ocelový plech
 reflektor: poniklovaný plech
 predradník: indukčný

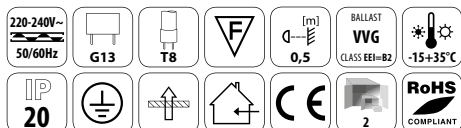

TAU VVG 4x18W

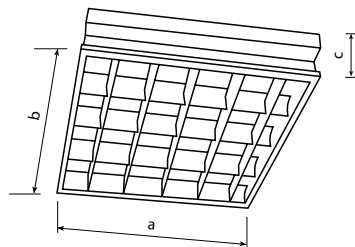
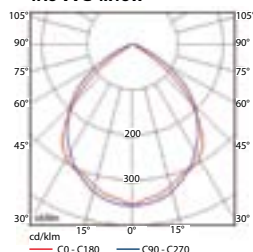

TAU VVG 4X18W



GXRV002



8592660102764



biela



4x18



600



600



80



3,80 kg

DKC

23,60 €

TOR 3

Svietidlo prisadené
teleso svietidla: plast
difuzor: sklo

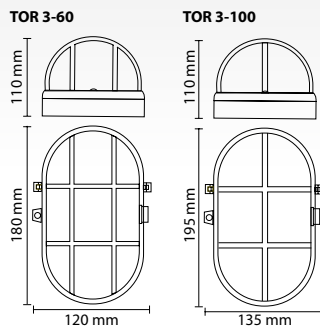

| | | |
|---------------------------|---------|------------|
| Doporučený svetelný zdroj | | DKC |
| BUDHA 4U 15W E27 | GXZK020 | 4,42 € |

| | | | | | | | DKC |
|--------------------|---------|---------------|-------|-----|-------|---------|------------|
| TOR 3-60/M | GXTT001 | 8592660103372 | biela | 60 | Kov | 0,47 kg | 2,76 € |
| TOR 3-60/P | GXTT002 | 8592660103389 | biela | 60 | Plast | 0,47 kg | 2,76 € |
| TOR 3-100/M | GXTT003 | 8592660103396 | biela | 100 | Kov | 0,54 kg | 3,96 € |

TOR 2

Svietidlo prisadené
teleso svietidla: plast
difuzor: sklo

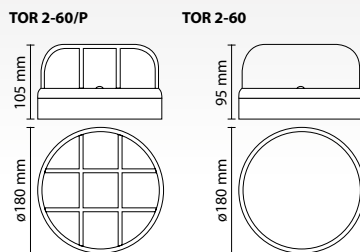

| | | |
|---------------------------|---------|------------|
| Doporučený svetelný zdroj | | DKC |
| MINI 4U 23W E27 | GXZK015 | 3,81 € |

| | | | | | | | DKC |
|-------------------|---------|---------------|-------|----|-------|---------|------------|
| TOR 2-60/P | GXTT004 | 8592660103402 | biela | 60 | Plast | 0,71 kg | 109 € |
| TOR 2-60 | GXTT005 | 8592660103419 | biela | 60 | - | 0,70 kg | 109 € |

TOR 1

Svietidlo prisadené
teleso svietidla: plast
difuzor: sklo

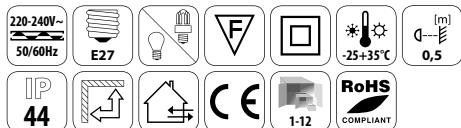
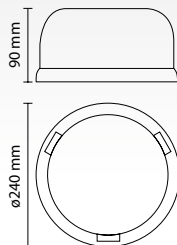

| | | |
|---------------------------|---------|------------|
| Doporučený svetelný zdroj | | DKC |
| MINI 4U 23W E27 | GXZK015 | 3,81 € |



TOR 1-100



GXTT006



8592660103426



biela



100



0,90 kg

DKC

5,96 €

RONDE E27

Svietidlo prisadené
teleso svietidla: plast
difuzor: sklo

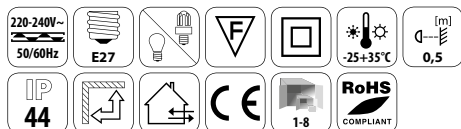
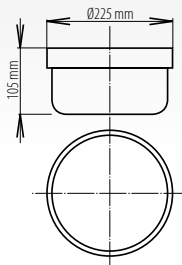

| | | |
|---------------------------|---------|------------|
| Doporučený svetelný zdroj | | DKC |
| MINI 4U 23W E27 | GXZK015 | 3,81 € |



RONDE E27



GXTT008



8592660104416



biela



100



1,10 kg

DKC

5,71 €

HALO 150

Halogénový reflektor

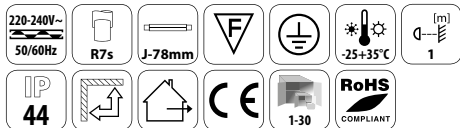
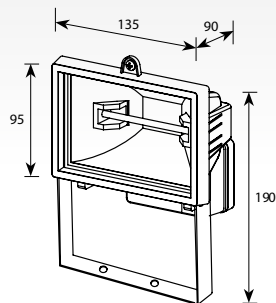

| | | |
|---------------------------|---------|------------|
| Doporučený svetelný zdroj | | DKC |
| J78 150W | GXZH003 | 0,65 € |

| | | | | | | |
|-------------------|---------|---------------|--------|-----|---------|------------|
| | | | | | | DKC |
| HALO 150 B | GXER008 | 8592660100944 | čierna | 150 | 0,33 kg | 3,81 € |
| HALO 150 W | GXER009 | 8592660100968 | biela | 150 | 0,33 kg | 3,81 € |

HALO 500

Halogénový reflektor

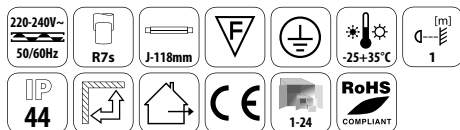
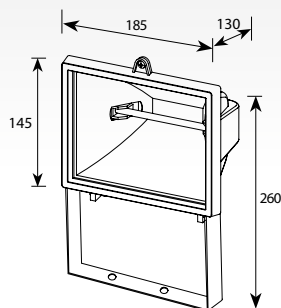

| | | |
|---------------------------|---------|------------|
| Doporučený svetelný zdroj | | DKC |
| J78 500W | GXZH008 | 0,65 € |

| | | | | | | |
|-------------------|---------|---------------|--------|-----|---------|------------|
| | | | | | | DKC |
| HALO 500 B | GXER010 | 8592660100975 | čierna | 500 | 0,63 kg | 4,96 € |
| HALO 500 W | GXER011 | 8592660100982 | biela | 500 | 0,63 kg | 4,96 € |

TOMI 150

Halogénový reflektor so senzorm pohybu

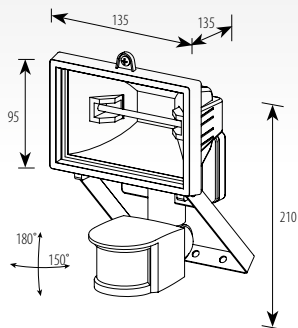

| | | |
|---------------------------|---------|------------|
| Doporučený svetelný zdroj | | DKC |
| J78 150W | GXZH003 | 0,65 € |



DKC

TOMI 150 B

GXER001

8592660100722

čierna

150

0,52 kg

13,42 €

TOMI 150 W

GXER002

8592660100739

biela

150

0,52 kg

13,42 €

TOMI 500

Halogénový reflektor so senzorm pohybu

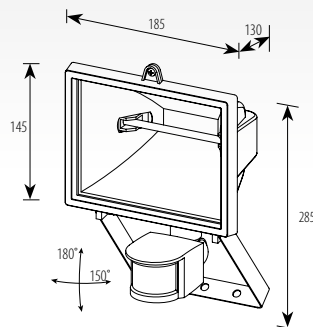

| | | |
|---------------------------|---------|------------|
| Doporučený svetelný zdroj | | DKC |
| J118 500W | GXZH008 | 0,65 € |



DKC

TOMI 500 B

GXER003

8592660100746

čierna

500

0,82 kg

15,35 €

TOMI 500 W

GXER004

8592660100753

biela

500

0,82 kg

15,35 €

HALO 2E27

Zářivkový reflektor

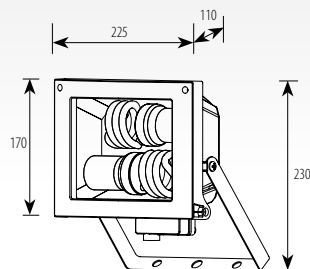

| | | |
|---------------------------|---------|------------|
| Doporučený svetelný zdroj | | DKC |
| SPIRE 20W E27 | GXZK030 | 4,19 € |

| | | | | | | |
|-------------|---------|---------------|--------|------|---------|------------|
| | | | | | | DKC |
| HALO 2E27 B | GXER007 | 8592660100951 | čierna | 2x20 | 1,30 kg | 18,81 € |

TOMI E27

Zářivkový reflektor
so senzorom pohybu

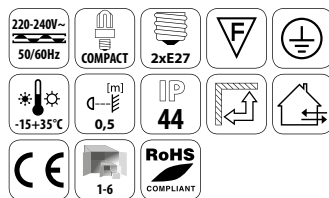
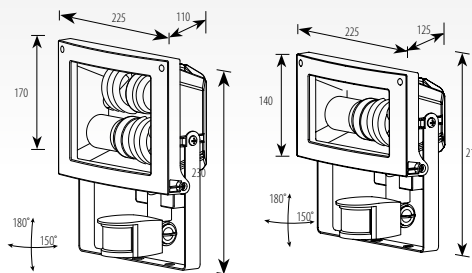

| | | |
|---------------------------|---------|------------|
| Doporučený svetelný zdroj | | DKC |
| SPIRE 20W E27 | GXZK030 | 4,19 € |

| | | | | | | |
|--------------------|---------|---------------|--------|------|---------|------------|
| | | | | | | DKC |
| TOMI 1E27 B | GXER006 | 8592660100777 | čierna | 1x20 | 0,95 kg | 23,04 € |
| TOMI 2E27 B | GXER005 | 8592660100760 | čierna | 2x20 | 1,13 kg | 24,96 € |

MH4 E40

Metalhalogenidový reflektor

teleso svietidla: hliník
reflektor: leštený hliník
difuzor: tvrdené sklo

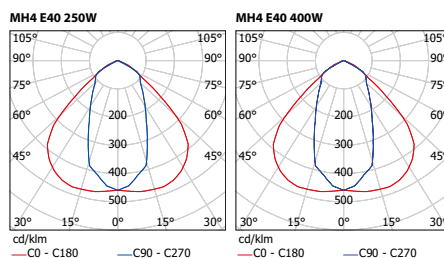
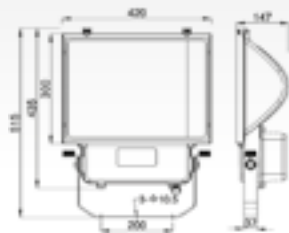

| | | | | | | | DKC | |
|--|------------------------|---------|---------------|--------|-----|-------------|------------|---------|
| | MH4 E40 250W | GXMH001 | 8592660103556 | čierna | 250 | symetrický | 6,50 kg | 58,23 € |
| | MH4 E40 400W | GXMH002 | 8592660103617 | čierna | 400 | symetrický | 7,40 kg | 61,15 € |
| | MH4 E40 250W/AS | GXMH003 | 8592660103624 | čierna | 250 | asymetrický | 6,50 kg | 51,75 € |
| | MH4 E40 400W/AS | GXMH004 | 8592660103631 | čierna | 400 | asymetrický | 7,40 kg | 58,23 € |

MH5 E40

Metalhalogenidový reflektor

teleso svietidla: hliník
reflektor: leštený hliník
difuzor: tvrdené sklo

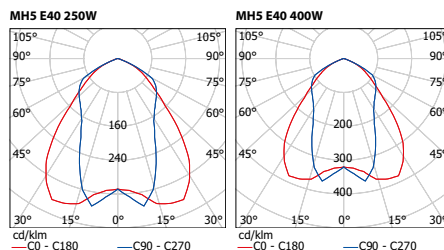
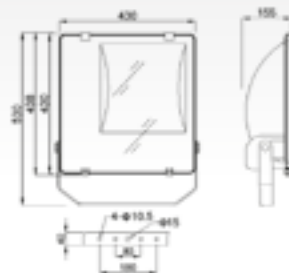

| | | | | | | | DKC | |
|--|------------------------|---------|---------------|--------|-----|-------------|------------|---------|
| | MH5 E40 250W | GXMH005 | 8592660103563 | čierna | 250 | symetrický | 8,10 kg | 60,67 € |
| | MH5 E40 400W | GXMH006 | 8592660103648 | čierna | 400 | symetrický | 8,90 kg | 67,03 € |
| | MH5 E40 250W/AS | GXMH007 | 8592660103655 | čierna | 250 | asymetrický | 8,10 kg | 60,51 € |
| | MH5 E40 400W/AS | GXMH008 | 8592660103662 | čierna | 400 | asymetrický | 8,90 kg | 66,87 € |

MH6 RX7S

Metalhalogenidový reflektor

teleso svietidla: hliník
reflektor: leštený hliník
difuzor: tvrdené sklo

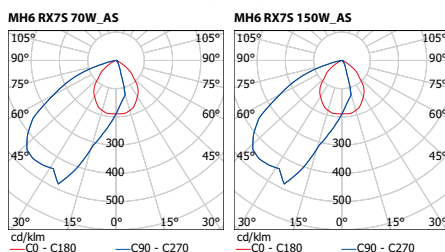
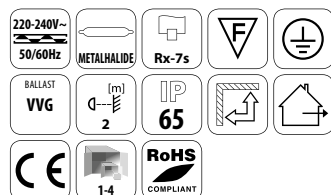
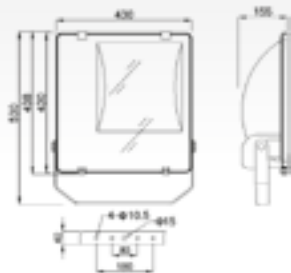

| Symbol | Code | EAN | Color | Power [W] | Beam Spread | Weight | Price |
|--------|---------|---------------|--------|-----------|-------------|---------|---------|
| | GXMH009 | 8592660103570 | čierna | 70 | asymetrický | 3,00 kg | 36,63 € |
| | GXMH010 | 8592660103587 | čierna | 150 | asymetrický | 4,50 kg | 44,80 € |

MH3 RX7S

Metalhalogenidový reflektor

teleso svietidla: hliník
reflektor: hliník
difuzor: tvrdené sklo

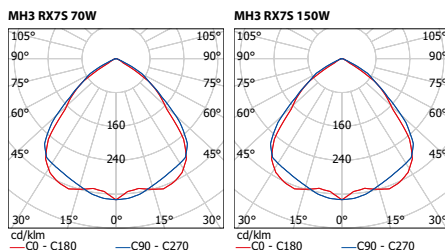
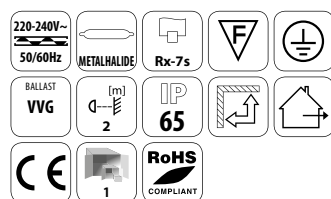
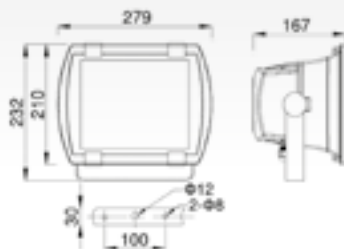

| Symbol | Code | EAN | Color | Power [W] | Beam Spread | Weight | Price |
|--------|---------|---------------|--------|-----------|-------------|---------|---------|
| | GXMH011 | 8592660103594 | čierna | 70 | | 3,50 kg | 38,67 € |
| | GXMH012 | 8592660103679 | čierna | 150 | | 4,40 kg | 44,80 € |

MH2 RX7S

Metalhalogenidový reflektor

teleso svietidla: hliník
 reflektor: hliník
 difuzor: tvrdené sklo

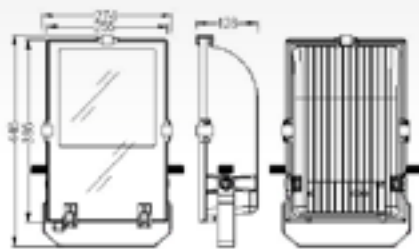

MH2 RX7S 70W

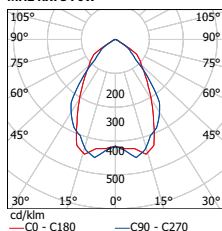

MH2 RX7S 150W

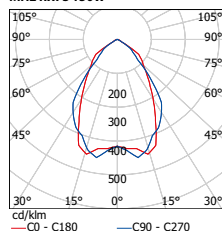

MH2 RX7S 70W_AS

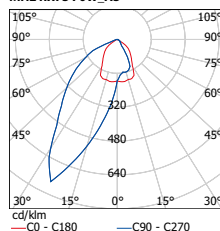

MH2 RX7S 150W_AS

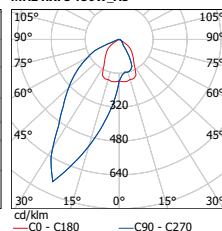

DKC

MH2 RX7S 70W

GXMH013

8592660103600

čierna

70

symetrický

4,90 kg

47,64 €

MH2 RX7S 150W

GXMH014

8592660103686

čierna

150

symetrický

5,70 kg

52,93 €

MH2 RX7S 70W/AS

GXMH015

8592660103693

čierna

70

asymetrický

4,90 kg

47,64 €

MH2 RX7S 150W/AS

GXMH016

8592660103709

čierna

150

asymetrický

5,70 kg

52,93 €

PODNIKOVÉ BODOVÉ SVĚTLIDLA





SLASH 2113

Podhľadové svietidlo na MR11

Pevné
Kovový výlisok

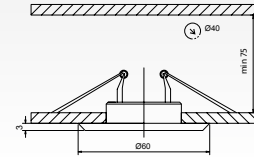
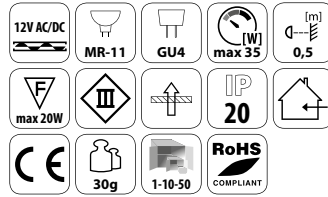

| Doporučený svetelný zdroj | | DKC |
|---------------------------|---------|--------|
| MR11 35W 30 | GXZH012 | 0,54 € |
| LED9 SMD MR11 2W-WW | GXLZ036 | 7,30 € |



CODE



DKC

SLASH 2113-C

2113

GXPP001

8592660101620

chróm

1,27 €

SLASH 2113-CM

2113

GXPP002

8592660101965

matný chróm

1,27 €



AXL 2114

Podhľadové svietidlo na MR16

Pevné
Kovový výlisok

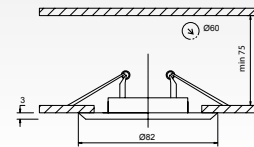
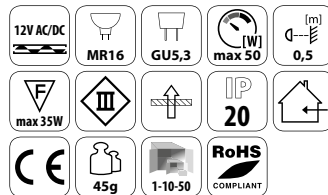

| Doporučený svetelný zdroj | | DKC |
|---------------------------|---------|---------|
| MR16 50W 60 | GXZH017 | 0,54 € |
| LED60 SMD MR16 4W-WW | GXLZ029 | 12,65 € |



CODE



DKC

AXL 2114-W

2114

GXPP003

8592660101972

biela

1,50 €

AXL 2114-G

2114

GXPP004

8592660101989

zlatá

1,50 €

AXL 2114-BRM

2114

GXPP006

8592660102009

matná mosadz

1,50 €

AXL 2114-A

2114

GXPP007

8592660102016

antik

1,50 €

AXL 2114-C

2114

GXPP008

8592660102023

chróm

1,50 €

AXL 2114-CM

2114

GXPP009

8592660102030

matný chróm

1,50 €

AXL 2114-GM

2114

GXPP010

8592660102047

čierny chróm

1,50 €

AXL 2114-YGM

2114

GXPP052

8592660104522

saténovo zlatá

1,50 €



SLASH 2119

Podhládové svietidlo na MR11

Výklopné
Kovový výlisok

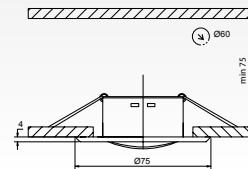

| Doporučený svetelný zdroj | | DKC |
|---------------------------|---------|--------|
| MR11 35W 30 | GXZH012 | 0,54 € |
| LED9 SMD MR11 2W-WW | GXLZ036 | 7,30 € |

| | CODE | | EAN | | DKC |
|---------------|------|---------|---------------|-------------|--------|
| SLASH 2119-C | 2119 | GXPP025 | 8592660102177 | chróm | 1,69 € |
| SLASH 2119-CM | 2119 | GXPP026 | 8592660102184 | matný chróm | 1,69 € |



AXL 2115

Podhládové svietidlo na MR16

Výklopné
Kovový výlisok

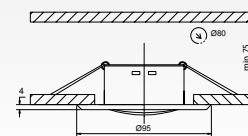

| Doporučený svetelný zdroj | | DKC |
|---------------------------|---------|---------|
| MR16 50W 60 | GXZH017 | 0,54 € |
| LED60 SMD MR16 4W-WW | GXLZ029 | 12,65 € |

| | CODE | | EAN | | DKC |
|--------------|------|---------|---------------|----------------|--------|
| AXL 2115-W | 2115 | GXPP030 | 8592660102207 | biela | 2,23 € |
| AXL 2115-G | 2115 | GXPP031 | 8592660102214 | zlatá | 2,23 € |
| AXL 2115-BRM | 2115 | GXPP033 | 8592660102221 | matná mosadz | 2,23 € |
| AXL 2115-A | 2115 | GXPP034 | 8592660102238 | antik | 2,23 € |
| AXL 2115-C | 2115 | GXPP035 | 8592660102245 | chróm | 2,23 € |
| AXL 2115-CM | 2115 | GXPP036 | 8592660102252 | matný chróm | 2,23 € |
| AXL 2115-GM | 2115 | GXPP037 | 8592660102269 | čierny chróm | 2,23 € |
| AXL 2115-YGM | 2115 | GXPP053 | 8592660104539 | saténovo zlatá | 2,23 € |



SLASH 2118

Podhľadové svietidlo na MR11

Rybie oko
Kovový výlisok

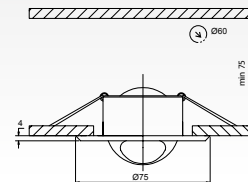

| Doporučený svetelný zdroj | | DKC |
|---------------------------|---------|--------|
| MR11 35W 30 | GXZH012 | 0,54 € |
| LED9 SMD MR11 2W-WW | GXLZ036 | 7,30 € |



SLASH 2118-C

CODE

2118



GXPP028



8592660102191



chróm

DKC

2,27 €



AXL 2117

Podhľadové svietidlo na MR16

Rybie oko
Kovový výlisok

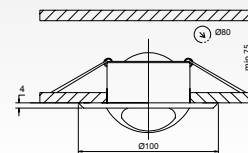

| Doporučený svetelný zdroj | | DKC |
|---------------------------|---------|---------|
| MR16 50W 60 | GXZH017 | 0,54 € |
| LED60 SMD MR16 4W-WW | GXLZ029 | 12,65 € |



AXL 2117-G

CODE

2117



GXPP039



8592660102276



zlatá

DKC

3,27 €

AXL 2117-BRM

2117

GXPP040

8592660102283

matná mosadz

3,27 €

AXL 2117-A

2117

GXPP041

8592660102290

antik

3,27 €

AXL 2117-C

2117

GXPP042

8592660102306

chróm

3,27 €

AXL 2117-CM

2117

GXPP043

8592660102313

matný chróm

3,27 €

AXL 2117-GM

2117

GXPP044

8592660102320

čierny chróm

3,27 €

AXL 2117-YGM

2117

GXPP054

8592660104546

saténovo zlatá

3,27 €



DUFF 204

Podhladové svietidlo na GU 10

Pevné
Kovový výlisok

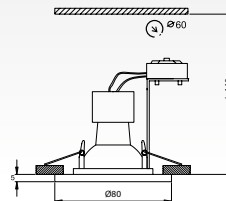

| Doporučený svetelný zdroj | | DKC |
|-----------------------------|---------|---------|
| JDR 50W 60 | GXZH020 | 1,50 € |
| LED24 SMD 5050 GU10 4W - WW | GXLZ045 | 14,75 € |



CODE



DKC

DUFF 204-C

204

GXPP023

8592660102153

chróm

3,42 €

DUFF 204-CM

204

GXPP024

8592660102160

matný chróm

3,42 €

DUFF 205

Podhladové svietidlo na GU 10

Výklopné
Kovový výlisok

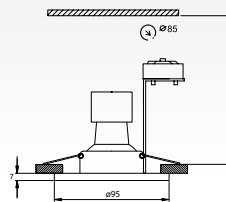
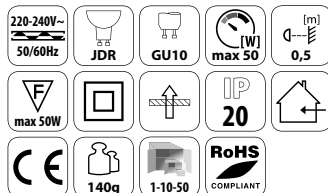

| Doporučený svetelný zdroj | | DKC |
|-----------------------------|---------|---------|
| JDR 50W 60 | GXZH020 | 1,50 € |
| LED24 SMD 5050 GU10 4W - WW | GXLZ045 | 17,75 € |



CODE



DKC

DUFF 205-C

205

GXPP050

8592660102382

chróm

3,81 €

DUFF 205-CM

205

GXPP051

8592660102399

matný chróm

3,81 €



AXL 3114

Podhládové svietidlo na MR16

Pevné
Kovový výlisok

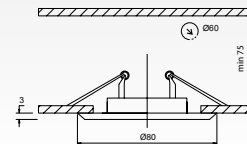

| Doporučený svetelný zdroj | | DKC |
|---------------------------|---------|---------|
| MR16 50W 60 | GXZH017 | 0,54 € |
| LED60 SMD MR16 4W-WW | GXLZ029 | 12,65 € |



CODE



DKC

| | | | | | |
|---------------|------|---------|---------------|----------------------------|--------|
| AXL 3114-SN/G | 3114 | GXPP011 | 8592660102054 | saténový nikel/ zlatá | 2,12 € |
| AXL 3114-SN/N | 3114 | GXPP012 | 8592660102061 | saténový nikel/nikel | 2,12 € |
| AXL 3114-PS/G | 3114 | GXPP013 | 8592660102078 | perleťová strieborná/zlatá | 2,12 € |
| AXL 3114-PG/N | 3114 | GXPP014 | 8592660102085 | perleťová zlatá/nikel | 2,12 € |



AXL 3115

Podhládové svietidlo na MR16

Výklopné
Kovový výlisok

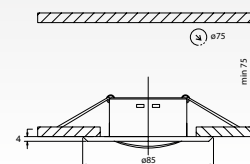

| Doporučený svetelný zdroj | | DKC |
|---------------------------|---------|---------|
| MR16 50W 60 | GXZH017 | 0,54 € |
| LED60 SMD MR16 4W-WW | GXLZ029 | 12,65 € |



CODE



DKC

| | | | | | |
|---------------|------|---------|---------------|----------------------------|--------|
| AXL 3115-SN/G | 3115 | GXPP045 | 8592660102337 | saténový nikel/zlatá | 2,27 € |
| AXL 3115-SN/N | 3115 | GXPP046 | 8592660102344 | saténový nikel/nikel | 2,27 € |
| AXL 3115-PS/G | 3115 | GXPP047 | 8592660102351 | perleťová strieborná/zlatá | 2,27 € |
| AXL 3115-PG/N | 3115 | GXPP048 | 8592660102368 | perleťová zlatá/nikel | 2,27 € |
| AXL 3115-GM/N | 3115 | GXPP049 | 8592660102375 | čierny chróm/nikel | 2,27 € |



AXL 5514

Podhládové svetidlo na MR16

Pevné

Odliatok z hliníkovej zliatiny

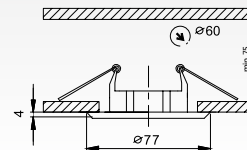

| Doporučený svetelný zdroj | | DKC |
|-----------------------------|---------|---------|
| MR16 50W 60 | GXZH017 | 0,54 € |
| LED60 SMD MR16 4W-WW | GXLZ029 | 12,65 € |

| | CODE | | EAN | | DKC |
|--------------------|------|---------|---------------|-------------|--------|
| AXL 5514-W | 5514 | GXPL001 | 8592660101637 | biela | 1,89 € |
| AXL 5514-A | 5514 | GXPL003 | 8592660101644 | antik | 1,89 € |
| AXL 5514-C | 5514 | GXPL004 | 8592660101651 | chróm | 1,89 € |
| AXL 5514-CM | 5514 | GXPL005 | 8592660101668 | matný chróm | 1,89 € |



AXL 5515

Podhládové svetidlo na MR16

Výklopné

Odliatok z hliníkovej zliatiny

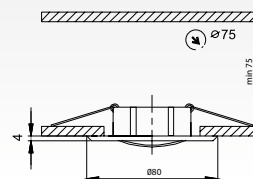

| Doporučený svetelný zdroj | | DKC |
|-----------------------------|---------|---------|
| MR16 50W 60 | GXZH017 | 0,54 € |
| LED60 SMD MR16 4W-WW | GXLZ029 | 12,65 € |

| | CODE | | EAN | | DKC |
|--------------------|------|---------|---------------|-------------|--------|
| AXL 5515-W | 5515 | GXPL024 | 8592660101828 | biela | 2,77 € |
| AXL 5515-A | 5515 | GXPL026 | 8592660101835 | antik | 2,77 € |
| AXL 5515-C | 5515 | GXPL028 | 8592660101842 | chróm | 2,77 € |
| AXL 5515-CM | 5515 | GXPL029 | 8592660101859 | matný chróm | 2,77 € |



AXL 5514

Podhľadové svietidlo na MR16

Pevné
Odliatok z hliníkovej zliatiny

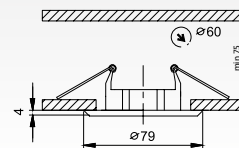

| Doporučený svetelný zdroj | | DKC |
|---------------------------|---------|---------|
| MR16 50W 60 | GXZH017 | 0,54 € |
| LED60 SMD MR16 4W-WW | GXLZ029 | 12,65 € |

| | CODE | | EAN | | DKC |
|----------------|------|---------|---------------|------------------------------|--------|
| AXL 5514-PCM/N | 5514 | GXPL016 | 8592660101743 | perleťové matný chróm/ nikel | 2,86 € |
| AXL 5514-PG/N | 5514 | GXPL017 | 8592660101750 | perleťová zlatá/nikel | 2,86 € |
| AXL 5514-SN/G | 5514 | GXPL018 | 8592660101767 | saténový nikel/zlatá | 2,86 € |
| AXL 5514-SN/N | 5514 | GXPL019 | 8592660101774 | saténový nikel/nikel | 2,86 € |
| AXL 5514-SG/N | 5514 | GXPL020 | 8592660101781 | saténové zlato/nikel | 2,86 € |



AXL 5515

Podhľadové svietidlo na MR16

Výklopné
Odliatok z hliníkovej zliatiny

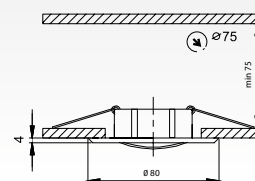

| Doporučený svetelný zdroj | | DKC |
|---------------------------|---------|---------|
| MR16 50W 60 | GXZH017 | 0,54 € |
| LED60 SMD MR16 4W-WW | GXLZ029 | 12,65 € |

| | CODE | | EAN | | DKC |
|----------------|------|---------|---------------|------------------------------|--------|
| AXL 5515-PCM/N | 5515 | GXPL041 | 8592660101910 | perleťové matný chróm/ nikel | 3,81 € |
| AXL 5515-PG/N | 5515 | GXPL042 | 8592660101927 | perleťová zlatá/nikel | 3,81 € |
| AXL 5515-SN/G | 5515 | GXPL043 | 8592660101934 | saténový nikel/zlatá | 3,81 € |
| AXL 5515-SN/N | 5515 | GXPL044 | 8592660101941 | saténový nikel/nikel | 3,81 € |
| AXL 5515-SG/N | 5515 | GXPL045 | 8592660101958 | saténové zlato/nikel | 3,81 € |



SLASH 5519

Podhládové svietidlo na MR11

Výklopné

Odliaatok z hliníkovej zliatiny

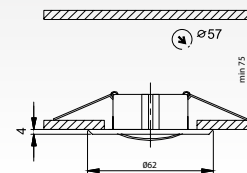

| Doporučený svetelný zdroj | | DKC |
|----------------------------|---------|--------|
| MR11 35W 30 | GXZH012 | 0,54 € |
| LED9 SMD MR11 2W-WW | GXLZ036 | 7,30 € |

| | CODE | | | | DKC |
|-------------------------|------|---------|---------------|-----------------------------|--------|
| SLASH 5519-CM | 5519 | GXPLO23 | 8592660101811 | matný chróm | 2,65 € |
| SLASH 5519-PCM/N | 5519 | GXPLO36 | 8592660101897 | perleťové matný chróm/nikel | 3,04 € |
| SLASH 5519-SN/N | 5519 | GXPLO40 | 8592660101903 | saténový nikel/nikel | 3,04 € |



AXL DS14

Podhládové svietidlo na MR16

Pevné

Odliaatok z hliníkovej zliatiny

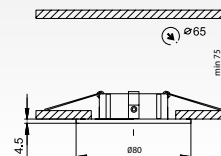

| Doporučený svetelný zdroj | | DKC |
|-----------------------------|---------|---------|
| MR16 50W 60 | GXZH017 | 0,54 € |
| LED60 SMD MR16 4W-WW | GXLZ029 | 12,65 € |

| | CODE | | | | DKC |
|----------------------|------|---------|---------------|----------------------------|--------|
| AXL DS14-PS/N | DS14 | GXPLO21 | 8592660101798 | perleťová strieborná/nikel | 3,42 € |
| AXL DS14-SN/G | DS14 | GXPLO22 | 8592660101804 | saténový nikel/zlatá | 3,42 € |



IZZY DS10

Podhľadové svietidlo na MR16

Pevný štvorec

Odliatok z hliníkovej zliatiny

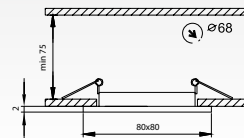

| Doporučený svetelný zdroj | | DKC |
|---------------------------|---------|---------|
| MR16 50W 60 | GXZH017 | 0,54 € |
| LED60 SMD MR16 4W-WW | GXLZ029 | 12,65 € |



CODE



EAN



DKC

IZZY DS10-Q-AB

DS10

GXPL009

8592660101675

broušená mosadz

2,65 €

IZZY DS10-Q-C

DS10

GXPL010

8592660101682

chróm

2,65 €

IZZY DS10-Q-SN

DS10

GXPL011

8592660101699

saténový nikel

2,65 €

IZZY DS10-Q-YGM

DS10

GXPL046

8592660104560

saténovo zlatá

2,65 €



IZZY DT10

Podhľadové svietidlo na MR16

Výklopný štvorec

Odliatok z hliníkovej zliatiny

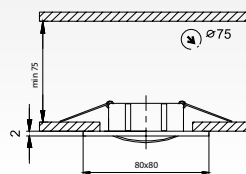

| Doporučený svetelný zdroj | | DKC |
|---------------------------|---------|---------|
| MR16 50W 60 | GXZH017 | 0,54 € |
| LED60 SMD MR16 4W-WW | GXLZ029 | 12,65 € |



CODE



EAN



DKC

IZZY DT10-Q-AB

DT10

GXPL033

8592660101866

broušená mosadz

3,81 €

IZZY DT10-Q-C

DT10

GXPL034

8592660101873

chróm

3,81 €

IZZY DT10-Q-CM

DT10

GXPL035

8592660101880

matný chróm

3,81 €

IZZY DT10-Q-YGM

DT10

GXPL047

8592660104577

saténovo zlatá

3,81 €



AXL DS050

Podhládové svetidlo na MR16

Pevné

Odliatok z hliníkovej zliatiny

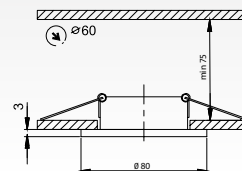

| Doporučený svetelný zdroj | | DKC |
|-----------------------------|---------|---------|
| MR16 50W 60 | GXZH017 | 0,54 € |
| LED60 SMD MR16 4W-WW | GXLZ029 | 12,65 € |



AXL DS050-AL

CODE

DS050



GXPA001



8592660101583



hliník

DKC

4,19 €



AXL DT050

Podhládové svetidlo na MR16

Výklopné

Odliatok z hliníkovej zliatiny

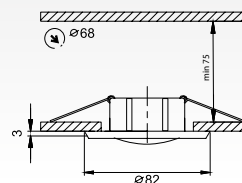

| Doporučený svetelný zdroj | | DKC |
|-----------------------------|---------|---------|
| MR16 50W 60 | GXZH017 | 0,54 € |
| LED60 SMD MR16 4W-WW | GXLZ029 | 12,65 € |



AXL DT050-AL

CODE

DT050



GXPA003



8592660101606



hliník

DKC

5,35 €



IZZY DSL50

Podhľadové svetidlo na MR16

Pevný štvorec

Odliahtok z hliníkovej zliatiny

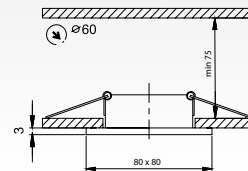

| Doporučený svetelný zdroj | | DKC |
|---------------------------|---------|---------|
| MR16 50W 60 | GXZH017 | 0,54 € |
| LED60 SMD MR16 4W-WW | GXLZ029 | 12,65 € |



IZZY DSL50-AL

CODE

DSL50



GXPA002



8592660101590



hliník

DKC

4,19 €



IZZY DTL50

Podhľadové svetidlo na MR16

Výklonný štvorec

Odliahtok z hliníkovej zliatiny

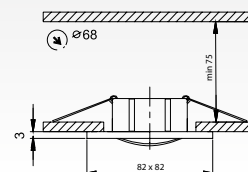

| Doporučený svetelný zdroj | | DKC |
|---------------------------|---------|---------|
| MR16 50W 60 | GXZH017 | 0,54 € |
| LED60 SMD MR16 4W-WW | GXLZ029 | 12,65 € |



IZZY DTL50 PA16V-AL

CODE

DTL50



GXPA004



8592660101613



hliník

DKC

5,35 €



OZZY 2116C

Podhládové svietidlo na JC
Hviezdne nebo
Odliatok z hliníkovej zliatiny

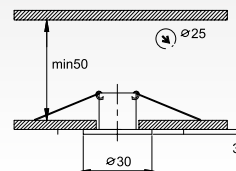
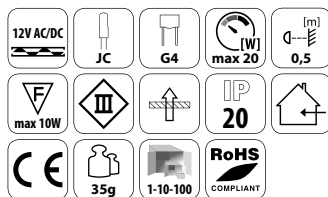

| Doporučený svetelný zdroj | | DKC |
|---------------------------|---------|--------|
| JC 20W G4 | GXZH029 | 0,42 € |
| LED13 SMD 5050 JC 2W - CW | GXLZ047 | 9,84 € |

| | CODE | | EAN | | DKC |
|---------------|-------|---------|---------------|-------------|--------|
| OZZY 2116C-W | 2116C | GXPL012 | 8592660101705 | biela | 1,58 € |
| OZZY 2116C-G | 2116C | GXPL013 | 8592660101712 | zlatá | 1,58 € |
| OZZY 2116C-C | 2116C | GXPL014 | 8592660101729 | chróm | 1,58 € |
| OZZY 2116C-CM | 2116C | GXPL015 | 8592660101736 | matný chróm | 1,58 € |



OZZY 2116B

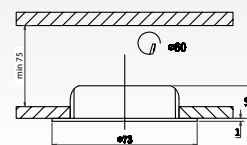
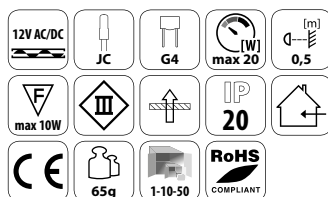

Nábytkové svietidlo JC
Nábytkové
Kovový výlisok/sklo



| Doporučený svetelný zdroj | | DKC |
|---------------------------|---------|--------|
| JC 20W G4 | GXZH029 | 0,42 € |
| LED18 SMD JC 1W-CW | GXLZ046 | 6,94 € |

| | CODE | | EAN | | DKC |
|----------------|-------|---------|---------------|----------------|--------|
| OZZY 2116B-W | 2116B | GXPP016 | 8592660102092 | biela | 2,08 € |
| OZZY 2116B-G | 2116B | GXPP017 | 8592660102108 | zlatá | 2,65 € |
| OZZY 2116B-BRM | 2116B | GXPP018 | 8592660102115 | matná mosadz | 2,65 € |
| OZZY 2116B-A | 2116B | GXPP019 | 8592660102122 | antik | 2,65 € |
| OZZY 2116B-C | 2116B | GXPP020 | 8592660102139 | chróm | 2,65 € |
| OZZY 2116B-CM | 2116B | GXPP021 | 8592660102146 | matný chróm | 2,65 € |
| OZZY 2116B-YGM | 2116B | GXPP055 | 8592660104553 | saténovo zlatá | 2,65 € |

Príslušenstvo

|  |  |  | Popis | DKC |
|---|---|---|------------------------------------|---------|
| Objímka LH-GZ10 | GXOS043 | 8592660103297 | Keramická objímka 220-240V GZ10 | 0,35 € |
| Objímka LH-GX5,3 | GXOS045 | 8592660103310 | Keramická objímka 12V GX5,3 | 0,23 € |
| TRAFO ET20 | GXOS053 | 8592660103457 | Elektronický transformátor 10-20W | 5,76 € |
| TRAFO ET60 | GXOS054 | 8592660103518 | Elektronický transformátor 20-60W | 6,50 € |
| TRAFO ET105 | GXOS055 | 8592660103501 | Elektronický transformátor 35-110W | 7,27 € |
| TRAFO ET150 | GXOS056 | 8592660103495 | Elektronický transformátor 50-150W | 12,65 € |
| TRAFO ET210 | GXOS057 | 8592660103488 | Elektronický transformátor 50-210W | 14,96 € |
| TRAFO SLIM60 | GXOS058 | 8592660103471 | Elektronický transformátor 20-60W | 10,35 € |
| TRAFO SLIM80 | GXOS059 | 8592660203461 | Elektronický transformátor 20-80W | 11,12 € |
| DRIVER LED3x1 | GXLD001 | 8592660103525 | Elektronický driver LED 1x3W | 9,96 € |
| DRIVER LED30 | GXLD002 | 8592660103532 | Elektronický driver LED 30W | 19,19 € |





CLASSIC E14

Kompaktná žiarivka

Životnosť: 10.000h

Trieda energetickej účinnosti (Ei): A

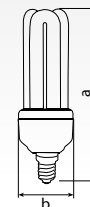

a [mm]

b [mm]



DKC

| CLASSIC 9W E14 | GXZK002 | 8592660100029 | 9 | 432 | 113 | 40 | 45 g | 2,86 € |
|-----------------|---------|---------------|----|-----|-----|----|------|--------|
| CLASSIC 11W E14 | GXZK004 | 8592660100050 | 11 | 587 | 124 | 40 | 50 g | 2,86 € |
| CLASSIC 15W E14 | GXZK006 | 8592660100043 | 15 | 741 | 133 | 40 | 60 g | 2,86 € |



CLASSIC E27

Kompaktná žiarivka

Životnosť: 10.000h

Trieda energetickej účinnosti (Ei): A

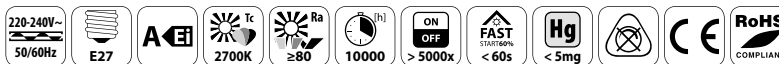
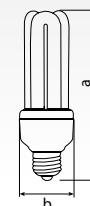

a [mm]

b [mm]



DKC

| CLASSIC 9W E27 | GXZK001 | 8592660100012 | 9 | 432 | 113 | 40 | 45 g | 1-10-50 | 2,86 € |
|-----------------|---------|---------------|----|------|-----|----|-------|---------|--------|
| CLASSIC 11W E27 | GXZK003 | 8592660100067 | 11 | 587 | 124 | 40 | 50 g | 1-10-50 | 2,86 € |
| CLASSIC 15W E27 | GXZK005 | 8592660100081 | 15 | 741 | 133 | 40 | 60 g | 1-10-50 | 2,86 € |
| CLASSIC 20W E27 | GXZK051 | 8592660100685 | 20 | 1180 | 168 | 48 | 90 g | 1-25-50 | 2,86 € |
| CLASSIC 23W E27 | GXZK052 | 8592660100678 | 23 | 1380 | 176 | 48 | 110 g | 1-25-50 | 2,86 € |



MINI E14

Kompaktná žiarivka

Životnosť: 8.000h

Trieda energetickej účinnosti (Ei): A

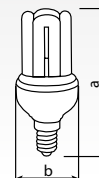

| | | | | | a [mm] | b [mm] | | DKC |
|------------------------|---------|---------------|----|-----|--------|--------|------|--------|
| MINI 4U 9W E14 | GXZK007 | 8592660100234 | 9 | 425 | 102 | 48 | 45 g | 3,04 € |
| MINI 4U 11W E14 | GXZK008 | 8592660100241 | 11 | 545 | 106 | 48 | 50 g | 3,04 € |
| MINI 4U 15W E14 | GXZK009 | 8592660100258 | 15 | 800 | 116 | 48 | 60 g | 3,04 € |



MINI E27

Kompaktná žiarivka

Životnosť: 8.000h

Trieda energetickej účinnosti (Ei): A

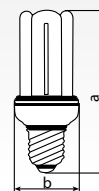

| | | | | | a [mm] | b [mm] | | DKC |
|------------------------|---------|---------------|----|------|--------|--------|-------|--------|
| MINI 4U 9W E27 | GXZK010 | 8592660100265 | 9 | 425 | 102 | 48 | 45 g | 3,81 € |
| MINI 4U 11W E27 | GXZK011 | 8592660100272 | 11 | 545 | 106 | 48 | 50 g | 3,81 € |
| MINI 4U 13W E27 | GXZK012 | 8592660100289 | 13 | 665 | 102 | 48 | 55 g | 3,81 € |
| MINI 4U 15W E27 | GXZK013 | 8592660100296 | 15 | 800 | 116 | 48 | 60 g | 3,81 € |
| MINI 4U 20W E27 | GXZK014 | 8592660100302 | 20 | 1200 | 137 | 48 | 95 g | 3,81 € |
| MINI 4U 23W E27 | GXZK015 | 8592660100319 | 23 | 1380 | 150 | 48 | 100 g | 3,81 € |



MAXI E14

Kompaktná žiarivka

Životnosť: 8.000h

Trieda energetickej účinnosti (Ei): A

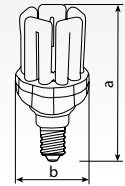

DKC

MAXI 5U 11W E14

GXZK046

8592660100487

11

545

95

44

65 g

4,58 €

MAXI 5U 15W E14

GXZK048

8592660100463

15

800

100

44

75 g

4,96 €



MAXI E27

Kompaktná žiarivka

Životnosť: 8.000h

Trieda energetickej účinnosti (Ei): A

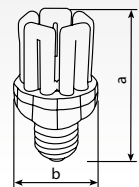

DKC

MAXI 5U 11W E27

GXZK047

8592660100470

11

545

95

44

65 g

4,58 €

MAXI 5U 15W E27

GXZK049

8592660100456

15

800

100

44

75 g

4,96 €



BUDHA E14

Kompaktná žiarivka

Životnosť: 10.000h

Trieda energetickej účinnosti (Ei): A

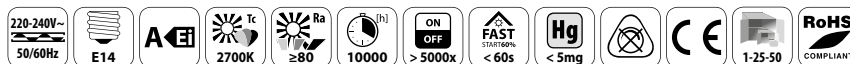
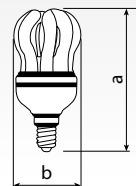

| | | | | | a [mm] | b [mm] | | DKC |
|-------------------------|---------|---------------|----|-----|--------|--------|------|--------|
| BUDHA 4U 9W E14 | GXZK016 | 8592660100326 | 9 | 450 | 101 | 47 | 45 g | 4,42 € |
| BUDHA 4U 11W E14 | GXZK018 | 8592660100340 | 11 | 550 | 105 | 49 | 50 g | 4,42 € |



BUDHA E27

Kompaktná žiarivka

Životnosť: 10.000h

Trieda energetickej účinnosti (Ei): A

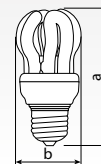

| | | | | | a [mm] | b [mm] | | DKC |
|-------------------------|---------|---------------|----|------|--------|--------|-------|--------|
| BUDHA 4U 9W E27 | GXZK017 | 8592660100333 | 9 | 450 | 101 | 47 | 45 g | 4,42 € |
| BUDHA 4U 11W E27 | GXZK019 | 8592660100357 | 11 | 550 | 105 | 49 | 50 g | 4,42 € |
| BUDHA 4U 15W E27 | GXZK020 | 8592660100364 | 15 | 800 | 113 | 57 | 60 g | 4,42 € |
| BUDHA 4U 18W E27 | GXZK021 | 8592660100371 | 18 | 1010 | 119 | 57 | 80 g | 4,42 € |
| BUDHA 4U 20W E27 | GXZK022 | 8592660100388 | 20 | 1152 | 128 | 62 | 85 g | 4,42 € |
| BUDHA 5U 24W E27 | GXZK023 | 8592660100395 | 24 | 1445 | 128 | 66 | 105 g | 4,42 € |



LOTOS E14

Kompaktná žiarivka

Životnosť: 10.000h

Trieda energetickej účinnosti (Ei): A

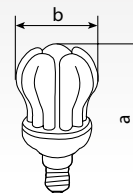

LOTOS 5U 14W E14



GXZK050



8592660100449



14



730

a [mm]

102

b [mm]

57



85 g

DKC

4,42 €



LOTOS E27

Kompaktná žiarivka

Životnosť: 10.000h

Trieda energetickej účinnosti (Ei): A

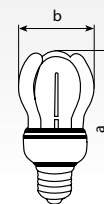

LOTOS 4U 11W E27



GXZK042



8592660100524



11



560

a [mm]

106

b [mm]

49



55 g

DKC

4,96 €

LOTOS 4U 15W E27

GXZK043

8592660100517

15

810

113

55

65 g

4,96 €

LOTOS 4U 20W E27

GXZK044

8592660100500

20

1155

128

64

80 g

5,35 €

LOTOS 5U 25W E27

GXZK045

8592660100494

25

1430

128

72

95 g

5,73 €









SPIRE E14

Kompaktná žiarivka

Životnosť: 8.000h

Trieda energetickej účinnosti (Ei): A



|  |  |  |  |  | a [mm] | b [mm] |  | DKC |
|---|---|---|---|---|--------|--------|---|--------|
| SPIRE 7W E14 | GXZK024 | 8592660100401 | 7 | 350 | 95 | 32 | 25 g | 3,81 € |
| SPIRE 9W E14 | GXZK025 | 8592660100418 | 9 | 440 | 97 | 32 | 35 g | 3,81 € |
| SPIRE 11W E14 | GXZK028 | 8592660100654 | 11 | 550 | 90 | 40 | 35 g | 3,81 € |









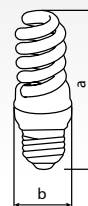

SPIRE E27

Kompaktná žiarivka

Životnosť: 8.000h

Trieda energetickej účinnosti (Ei): A



|  |  |  |  |  |  | a [mm] | b [mm] |  | DKC |
|---|---|---|---|---|---|--------|--------|---|--------|
| SPIRE 9W E27 | GXZK026 | 8592660100425 | 9 | 2700K | 440 | 97 | 32 | 30 g | 3,81 € |
| SPIRE 11W E27 | GXZK027 | 8592660100432 | 11 | 2700K | 550 | 90 | 40 | 35 g | 3,81 € |
| SPIRE 15W E27 | GXZK029 | 8592660100647 | 15 | 2700K | 800 | 98 | 45 | 50 g | 4,19 € |
| SPIRE 20W E27 | GXZK030 | 8592660100630 | 20 | 2700K | 1152 | 115 | 52 | 70 g | 4,19 € |
| SPIRE 25W E27 - CW | GXZK066 | 8592660104751 | 25 | 6400K | 1595 | 130 | 65 | 90 g | 4,19 € |
| SPIRE 25W E27 - WW | GXZK065 | 8592660104768 | 25 | 2700K | 1595 | 130 | 65 | 90 g | 4,19 € |



GLOBE E14

Kompaktná žiarivka

Životnosť: 10.000h

Trieda energetickej účinnosti (Ei): A

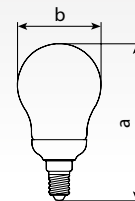

GLOBE 11W E14



GXZK034



8592660100593



11



535



112



55



55 g

DKC

3,42 €



GLOBE E27

Kompaktná žiarivka

Životnosť: 10.000h

Trieda energetickej účinnosti (Ei): A

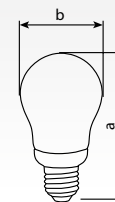

GLOBE 11W E27



GXZK035



8592660100586



11



535



112



55



55 g

DKC

3,42 €

GLOBE 15W E27

GXZK036

8592660100579

15

800

129

60

75 g

5,50 €

GLOBE 20W E27

GXZK037

8592660100562

20

1155

149

65

130 g

5,50 €



OpenGLOBE E27

Kompaktná žiarivka

Životnosť: 10.000h

Trieda energetickej účinnosti (Ei): A

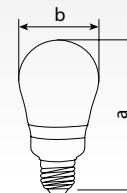

OpenGLOBE 15W E27



GXZK032



8592660100616



15



800



112



60



75 g



6,89 €



OrbGLOBE E27

Kompaktná žiarivka

Životnosť: 10.000h

Trieda energetickej účinnosti (Ei): A

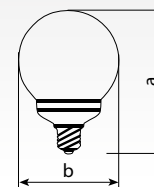

OrbGLOBE 20W E27



GXZK033



8592660100609



20



900



171



120



155 g



5,35 €



CANDLE E14

Kompaktná žiarivka

Životnosť: 10.000h

Trieda energetickej účinnosti (Ei): A

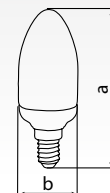

DKC

CANDLE 7W E14

GXZK038

8592660100555

7

320

101

38

50 g

4,19 €

CANDLE 9W E14

GXZK039

8592660100548

9

420

111

38

55 g

4,19 €



EddyCANDLE E14

Kompaktná žiarivka

Životnosť: 10.000h

Trieda energetickej účinnosti (Ei): A

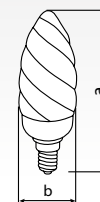

DKC

EddyCANDLE 7W E14

GXZK041

8592660100692

7

300

103

40

50 g

4,96 €



SPOT GU10

Kompaktná žiarivka

Životnosť: 10.000h

Trieda energetickej účinnosti (Ei): A

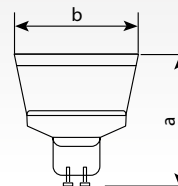

| | | | | | a [mm] | b [mm] | | DKC |
|----------------------|---------|---------------|----|-----|--------|--------|------|--------|
| SPOT 9W GU10 | GXZK054 | 8592660100920 | 9 | 200 | 76 | 50 | 50 g | 7,27 € |
| SPOT 11W GU10 | GXZK055 | 8592660100937 | 11 | 220 | 76 | 50 | 55 g | 7,65 € |



MR11

Halogenová žiarovka

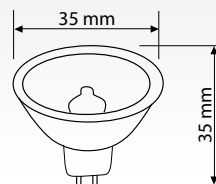

MR11 20W 30



GXZH011



8592660101132



20



30



400

DKC

0,54 €

MR11 35W 30

GXZH012

8592660101200

35

30

630

0,54 €



MR16

Halogenová žiarovka

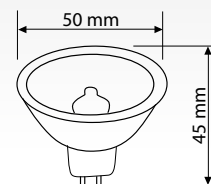

MR16 20W 36



GXZH013



8592660101149



20



36



400

DKC

0,54 €

MR16 20W 60

GXZH014

8592660101217

20

60

230

0,54 €

MR16 35W 36

GXZH015

8592660101224

35

36

800

0,54 €

MR16 35W 60

GXZH016

8592660101231

35

60

680

0,54 €

MR16 50W 60

GXZH017

8592660101248

50

60

870



0,54 €

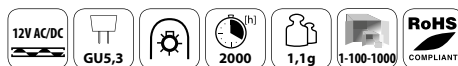
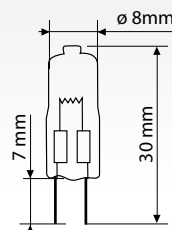

JC G4

Halogenová žiarovka



|  |  |  |  |  | DKC |
|---|---|---|--|---|--------|
| JC 5W G4 | GXZH027 | 8592660101187 | 5 | 45 | 0,42 € |
| JC 10W G4 | GXZH028 | 8592660101316 | 10 | 120 | 0,42 € |
| JC 20W G4 | GXZH029 | 8592660101323 | 20 | 250 | 0,42 € |
| JC 35W G4 | GXZH030 | 8592660101330 | 35 | 450 | 0,42 € |



JC GY6,35

Halogenová žiarovka

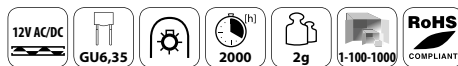
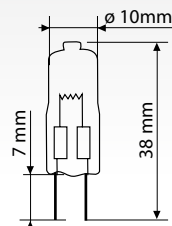

|  |  |  |  |  | DKC |
|---|---|---|--|---|--------|
| JC 20W GY6,35 | GXZH031 | 8592660101194 | 20 | 250 | 0,54 € |
| JC 35W GY6,35 | GXZH032 | 8592660101347 | 35 | 450 | 0,54 € |
| JC 50W GY6,35 | GXZH033 | 8592660101354 | 50 | 650 | 0,54 € |



G9

Halogenová žiarovka

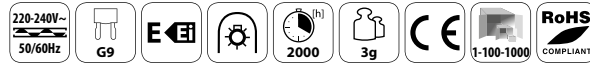
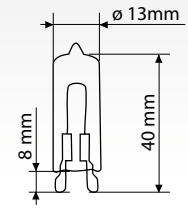

G9 25W

G9 40W



GXZH024

GXZH025



8592660101170

8592660101293



25

40



220

420

DKC

0,96 €

0,96 €

J78, 118, 189, 254

Špeciálna projektorová Halogenová žiarovka

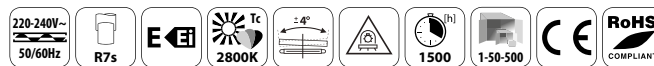
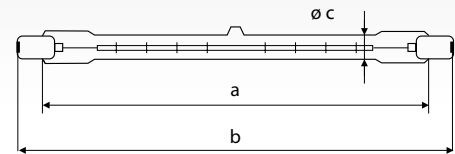

J78 60W

J78 100W

J78 150W

J118 100W

J118 150W

J118 200W

J118 300W

J118 500W

J189 1000W

J254 1500W



GXZH001

GXZH002

GXZH003

GXZH004

GXZH005

GXZH006

GXZH007

GXZH008

GXZH009

GXZH010



8592660101064

8592660101071

8592660101088

8592660101040

8592660101095

8592660101101

8592660101118

8592660101125

8592660101057

8592660101033



60

100

150

100

150

200

300

500

1000

1500



800

1200

2000

1200

2000

2800

4500

8000

20000

30000



74

74

74

114

114

114

114

114

185

250



78

78

78

118

118

118

118

118

189

254



8

8

8

8

8

8

8

8

9

10



6g

6g

6g

8g

8g

8g

8g

8g

15g

20g

DKC

0,65 €

0,65 €

0,65 €

0,65 €

0,65 €

0,65 €

0,65 €

0,65 €

1,42 €

1,46 €



JDR

Halogenová žiarovka

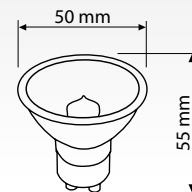

| | | | | | | DKC |
|-------------------|---------|---------------|----|----|-----|--------|
| JDR 25W 60 | GXZH018 | 8592660101156 | 25 | 60 | 180 | 1,50 € |
| JDR 35W 60 | GXZH019 | 8592660101255 | 35 | 60 | 300 | 1,50 € |
| JDR 50W 60 | GXZH020 | 8592660101262 | 50 | 60 | 430 | 1,50 € |



JCDR*

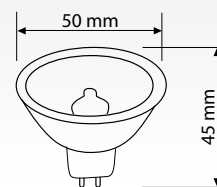

Halogenová žiarovka



| | | | | | | DKC |
|--------------------|---------|---------------|----|----|-----|-----|
| JCDR 25W 38 | GXZH021 | 8592660101163 | 25 | 38 | 180 | - |
| JCDR 35W 38 | GXZH022 | 8592660101279 | 35 | 38 | 300 | - |
| JCDR 50W 38 | GXZH023 | 8592660101286 | 50 | 38 | 430 | - |

* tovar dostupný len v Polsku

Príslušenstvo

|  |  |  | popis | DKC |
|---|---|---|------------------------------------|---------|
| Objímka LH-GZ10 | GXOS043 | 8592660103297 | Keramická objímka 220-240V GZ10 | 0,35 € |
| Objímka LH-GX5,3 | GXOS045 | 8592660103310 | Keramická objímka 12V GX5,3 | 0,23 € |
| Objímka LH-R7S | GXOS044 | 8592660103303 | Keramická objímka 220-240V R7S | 0,23 € |
| Objímka LH-E27 | GXOS046 | 8592660103327 | Keramická objímka E27 | 0,23 € |
| Objímka LH-E27F | GXOS047 | 8592660103334 | Keramická objímka E27 | 0,23 € |
| Objímka LH-E27D | GXOS048 | 8592660103341 | Keramická objímka E27 | 0,23 € |
| Objímka LH-E14 | GXOS049 | 8592660103358 | Keramická objímka E14 | 0,23 € |
| TRAFO ET20 | GXOS053 | 8592660103457 | Elektronický transformátor 10-20W | 5,76 € |
| TRAFO ET60 | GXOS054 | 8592660103518 | Elektronický transformátor 20-60W | 6,50 € |
| TRAFO ET105 | GXOS055 | 8592660103501 | Elektronický transformátor 35-105W | 7,27 € |
| TRAFO ET150 | GXOS056 | 8592660103495 | Elektronický transformátor 50-150W | 12,65 € |
| TRAFO ET210 | GXOS057 | 8592660103488 | Elektronický transformátor 50-210W | 14,96 € |
| TRAFO SLIM60 | GXOS058 | 8592660103471 | Elektronický transformátor 20-60W | 10,35 € |
| TRAFO SLIM80 | GXOS059 | 8592660103464 | Elektronický transformátor 20-80W | 11,12 € |
| DRIVER LED3x1 | GXLD001 | 8592660103525 | Elektronický driver LED 3x1W | 9,96 € |
| DRIVER LED30 | GXLD002 | 8592660103532 | Elektronický driver LED 30W | 19,19 € |





SENSOR 10/20

Pohybový senzor

Maximálne 1200W

Rozsah senzora 360°

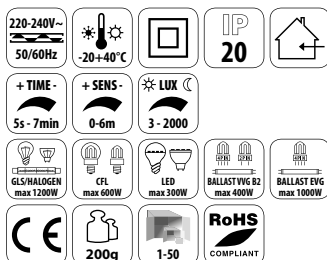
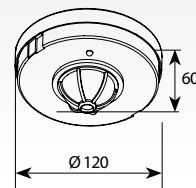

DKC

SENSOR 10

GXSI001

8592660100876

biela

360

160

max 6m

7,65 €

SENSOR 20

GXSI002

8592660100883

biela

360

180

max 12m

9,96 €



SENSOR 30

Pohybový senzor

Maximálne 1200W

Rozsah senzora 360°

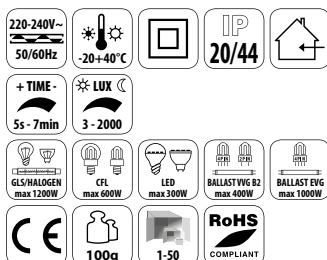
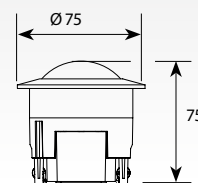

DKC

SENSOR 30

GXSI003

8592660100890

biela

360

160

max 6m

10,35 €



SENSOR 40

Pohybový senzor

Maximálne 600W

Rozsah senzora 140°

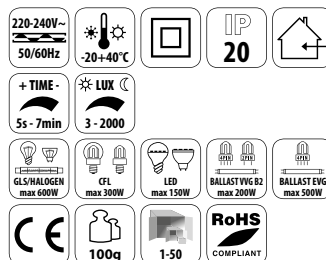
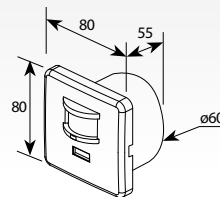

SENSOR 40



GXSI004



8592660100906



biela



140



max 9m

DKC

10,35 €



SENSOR 50

Pohybový senzor

Maximálne 60W

Rozsah senzora 360°

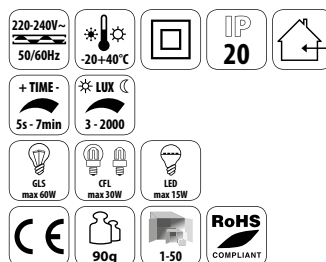
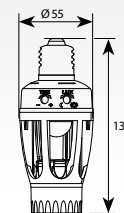

SENSOR 50



GXSI005



8592660100913



biela



360



140



max 6m

DKC

13,04 €



SENSOR 60

Pohybový senzor
Maximálne 1200W
Rozsah senzora 180°

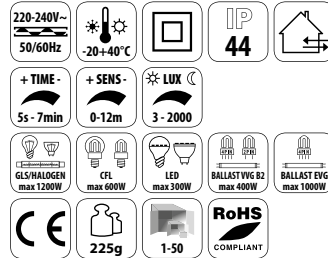
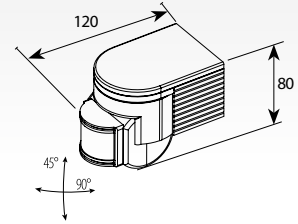

SENSOR 60 W

SENSOR 60 B



GXSE001

GXSE002



8592660100814

8592660100821



biela

čierna



180

180



max 12m

max 12m

DKC

10,35 €

10,35 €



SENSOR 70

Pohybový senzor
Maximálne 1200W
Rozsah senzora 180°

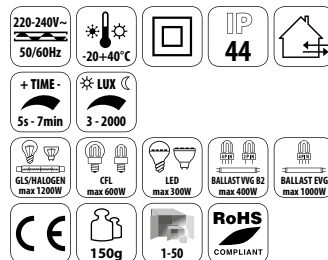
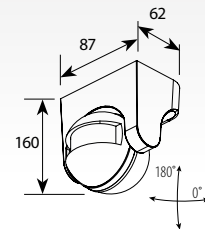

SENSOR 70 W

SENSOR 70 B



GXSE003

GXSE004



8592660100838

8592660100845



biela

čierna



180

180



max 12m

max 12m

DKC

11,50 €

11,50 €



SENSOR 80

Pohybový senzor

Maximálne 1200W

Rozsah senzora 180°

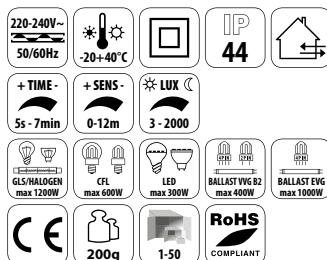
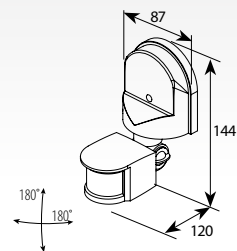

|  |  |  |  |  |  | DKC |
|--|---|---|---|---|---|------------|
| SENSOR 80 W | GXSE005 | 8592660100852 | biela | 180 | max 12m | 10,35 € |
| SENSOR 80 B | GXSE006 | 8592660100869 | čierna | 180 | max 12m | 10,35 € |



TRAF0

Elektronický transformátor

- odolné proti skratu
- s tepelnou ochranou

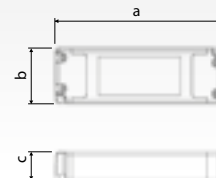

| | | | | | | a [mm] | b [mm] | c [mm] | | | DKC |
|-------------|---------|---------------|-------|-----|--------|--------|--------|--------|------|-------|---------|
| TRAFO ET20 | GX0S053 | 8592660103457 | biela | 20 | 10-20 | 65 | 35 | 20 | 50g | 1-200 | 5,76 € |
| TRAFO ET60 | GX0S054 | 8592660103518 | biela | 60 | 20-60 | 110 | 36 | 21 | 80g | 1-104 | 6,50 € |
| TRAFO ET105 | GX0S055 | 8592660103501 | biela | 105 | 35-105 | 130 | 43 | 21 | 115g | 1-80 | 7,27 € |
| TRAFO ET150 | GX0S056 | 8592660103495 | biela | 150 | 50-150 | 160 | 46 | 33 | 200g | 1-45 | 12,65 € |
| TRAFO ET210 | GX0S057 | 8592660103488 | biela | 210 | 50-210 | 160 | 46 | 33 | 220g | 1-45 | 14,96 € |



TRAF0 SLIM

Elektronický transformátor

- odolné proti skratu
- s tepelnou ochranou

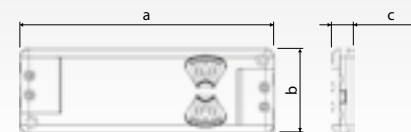

| | | | | | | a [mm] | b [mm] | c [mm] | | | DKC |
|--------------|---------|---------------|-------|----|-------|--------|--------|--------|-----|-------|---------|
| TRAFO SLIM60 | GX0S058 | 8592660103471 | biela | 60 | 20-60 | 126 | 43 | 10,5 | 80g | 1-168 | 10,35 € |
| TRAFO SLIM80 | GX0S059 | 8592660103464 | biela | 80 | 20-80 | 135 | 46 | 12,5 | 90g | 1-110 | 11,12 € |



DRIVER LED3x1

Elektronický DRIVER LED

- odolné proti skratu
- s tepelnou ochranou



DRIVER LED3x1



GXLD001



8592660103525



biela



3



0-3

DKC

9,96 €



DRIVER LED30

Elektronický DRIVER LED

- odolné proti skratu
- s tepelnou ochranou

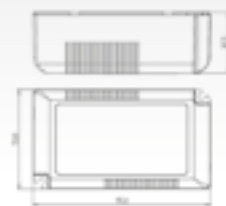

DRIVER LED30



GXLD002



8592660103532



biela



30



0-30

DKC

19,19 €



WG

Bezšroubová svorkovnica
Svorkovnice je možné spájať
Predaj len na celé balenie

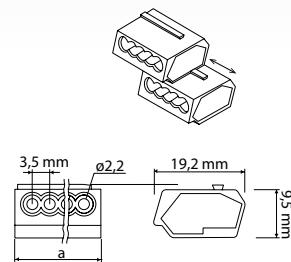
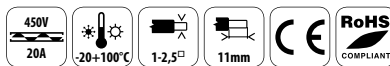

a [mm]



DKC/ks

DKC

| Bezšroubová svorkovnica WG-2 | GXOS038 | 8592660104430 | 2P | 10,0 | 100-1000 | 0,06 € | 6,00 € |
|------------------------------|---------|---------------|----|------|----------|--------|--------|
| Bezšroubová svorkovnice WG-3 | GXOS039 | 8592660104447 | 3P | 13,5 | 100-1000 | 0,07 € | 7,00 € |
| Bezšroubová svorkovnice WG-4 | GXOS040 | 8592660104454 | 4P | 17,0 | 100-1000 | 0,08 € | 8,00 € |
| Bezšroubová svorkovnice WG-5 | GXOS041 | 8592660104461 | 5P | 20,5 | 50-500 | 0,10 € | 5,00 € |
| Bezšroubová svorkovnice WG-8 | GXOS042 | 8592660104478 | 8P | 31,0 | 50-500 | 0,18 € | 9,00 € |



TB*

Šrobová svorkovnica
Predaj len na celé balenie

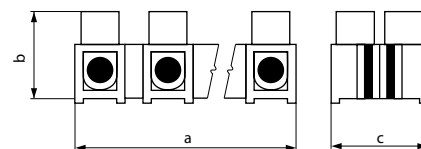

a [mm]

b [mm]

c [mm]

DKC

| TB - 2,5 mm PE | GXOS093 | 8592660104164 | 10P | 1÷2,5 [□] | bílá | 10-1000 | 76,4 | 13,0 | 17,0 | - |
|----------------|---------|---------------|-----|--------------------|------|---------|-------|------|------|---|
| TB - 4 mm PE | GXOS094 | 8592660104171 | 10P | 1,5÷4 [□] | bílá | 10-1000 | 94,8 | 15,5 | 18,8 | - |
| TB - 6 mm PE | GXOS095 | 8592660104188 | 10P | 2,5÷6 [□] | bílá | 10-500 | 106,6 | 16,7 | 20,7 | - |
| TB - 10 mm PE | GXOS096 | 8592660104195 | 10P | 4÷10 [□] | bílá | 10-500 | 115,1 | 18,7 | 22,6 | - |
| TB - 16 mm PE | GXOS097 | 8592660104201 | 10P | 6÷16 [□] | bílá | 10-300 | 136,7 | 19,8 | 24,1 | - |

* tovar dostupný len v Polsku



OBJÍMKA LH-GZ10

Keramická objímka

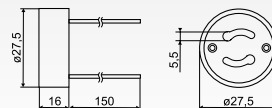

Objímka LH-GZ10



GXOS043



8592660103297

DKC

0,35 €



OBJÍMKA LH-R7S

Keramická objímka

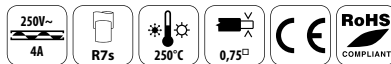
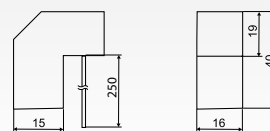

Objímka LH-R7S



GXOS044



8592660103303

DKC

0,23 €



OBJÍMKA LH-GX5,3

Keramická objímka

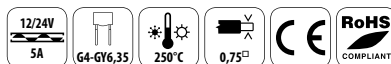
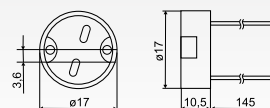

Objímka LH-GX5,3



GXOS045



8592660103310

DKC

6 €



OBJÍMKA LH-E27

Keramiká objímka

LH-E27

LH-E27F

LH-E27D

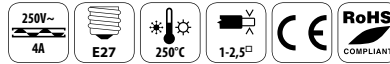
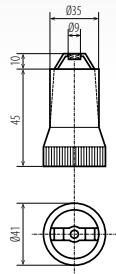
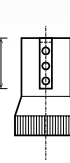
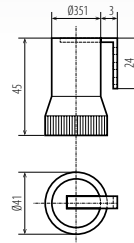
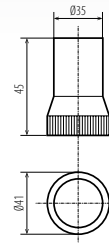

OBJÍMKA LH-E27



GX0S046



8592660103327

DKC

0,23 €

OBJÍMKA LH-E27F

GX0S047

8592660103334

0,23 €

Objímka LH-E27D

GX0S048

8592660103341

0,23 €



OBJÍMKA LH-E14

Keramiká objímka

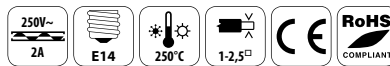
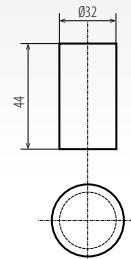

Objímka LH-E14



GX0S049



8592660103358

DKC

0,23 €



Predradník EVG

Elektronický predradník triedy A2

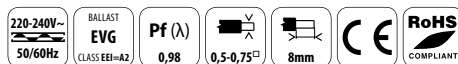
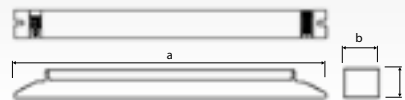

| | | EAN | a [mm] | b [mm] | c [mm] | | | | | U-out | | DKC |
|-----------------------------------|---------|---------------|--------|--------|--------|------|---------|---------|--|-------|------|---------|
| | | | | | | [W] | Ta [°C] | Tc [°C] | | | | |
| Predradník - EVG 2x36W | GXOS030 | 8592660102689 | 275 | 28 | 26 | 2x36 | -25 +50 | 75 | | <450V | 260g | 11,12 € |
| Predradník - EVG 2x58W | GXOS031 | 8592660102696 | 336 | 33 | 29 | 2x58 | -25 +50 | 75 | | <450V | 300g | 13,81 € |
| Predradník - EVG DP 2x36W* | GXOS003 | 8592660101460 | 278 | 30 | 30 | 2x36 | -15 +50 | 70 | | <250V | 240g | 14,58 € |
| Predradník - EVG DP 2x58W* | GXOS009 | 8592660101521 | 315 | 30 | 30 | 2x58 | -15 +50 | 70 | | <250V | 300g | 15,35 € |

*teplý start

Predradník VVG

Indukčný predradník triedy B2

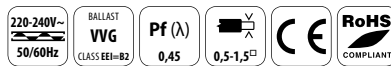

| | | EAN | a [mm] | b [mm] | c [mm] | | | | | | DKC |
|-----------------------------|---------|---------------|--------|--------|--------|-----|---------|---------|---------|------|--------|
| | | | | | | [W] | Ta [°C] | Tc [°C] | Tw [°C] | | |
| Predradník - VVG 18W | GXOS052 | 8592660103365 | 155 | 42 | 28 | 18 | -5 +40 | 120 | 130 | 500g | 4,96 € |
| Predradník - VVG 36W | GXOS032 | 8592660102702 | 155 | 42 | 28 | 36 | -5 +40 | 120 | 130 | 500g | 5,35 € |
| Predradník - VVG 58W | GXOS033 | 8592660102719 | 195 | 42 | 28 | 58 | -5 +40 | 120 | 130 | 820g | 7,65 € |



ROZBOČKA RO2-1

Rozbočka



DKC

Rozbočka RO2-1

GXOS060

8592660103716

0,96 €



ROZBOČKA RO3

Rozbočka



DKC

Rozbočka RO3

GXOS061

8592660103723

1,08 €



ZÁSTRČKA ZA

Zástrčka



DKC

Zástrčka ZA

GXOS062

8592660103730

0,88 €



ZÁSTRČKA ZS

Zástrčka ZS

- Vybavená ochranným kontaktom
- Snadno Rozebíratelná



DKC

Zástrčka ZS

GX0S063

8592660103747

0,89 €



ZÁSTRČKA ZA IP44

Zástrčka ZA IP44



DKC

Zástrčka ZA IP44

GX0S064

8592660103877

2,31 €



ZÁSTRČKA ZS IP44

Zástrčka ZS IP44



DKC

Zástrčka ZS IP44

GX0S065

8592660103884

1,62 €



TAPE

Izolačná páska čierna
predaj: balení (10 ks)

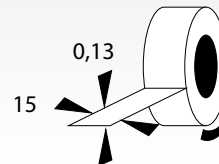

DKC/ks

DKC

TAPE/10-B

GX0S080

8592660104485

10

10-300

0,21 Kč

2,10 €

TAPE/20-B

GX0S082

8592660104492

20

10-200

0,40 Kč

4,00 €



TAPE MIX

Izolačná páska
3x čierna
2x modrá
1x žltá, červená, zelená, biela, žluto-zelená
predaj: balení (10 ks)

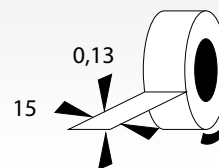

DKC

TAPE/10-MIX

GX0S081

8592660103907

10

10-300

2,12 €

TAPE/20-MIX

GX0S083

8592660103921

20

10-200

4,23 €



STARTER 4-22W

Starter

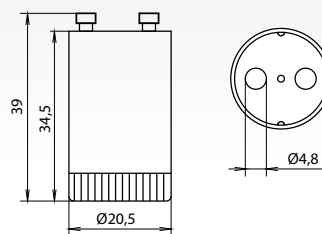

DKC/ks

DKC

Starter 4-22W

GX0S090

8592660104423

4-22

0,23 €

5,75 €



STARTER 4-65W

Starter

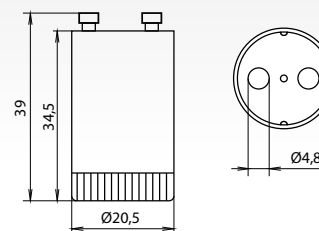

DKC/ks

DKC

Starter 4-65W

GX0S091

8592660104508

4-65

0,23 €

5,75 €





TAURUS 1E27

Svietidlo žiarivkové prisadené.

Vhodné pre vonkajšie použitie.

Vhodné pro použití do koupelny.

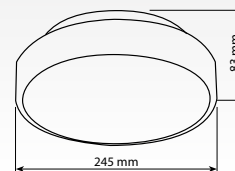
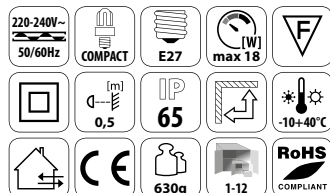

Doporučený svetelný zdroj



DKC

SPIRE 15W E27

GXZK029

4,19 €



TAURUS 1E27 GR



GXIZ001



8592660100036



šedá

DKC

23,96 €

TAURUS 1E27 W

GXIZ002

8592660100104

biela

23,96 €

TAURUS 1E27 G

GXIZ003

8592660100111

zlatá

23,96 €

TAURUS 2E27

Svietidlo žiarivkové prisadené.

Vhodné pre vonkajšie použitie.

Vhodné pro použití do koupelny.

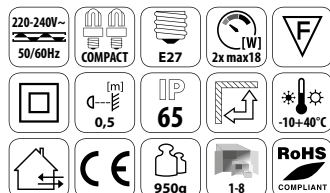
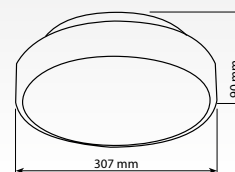

Doporučený svetelný zdroj



DKC

SPIRE 15W E27

GXZK029

4,19 €



TAURUS 2E27 GR



GXIZ004



8592660100128



šedá

DKC

29,96 €

TAURUS 2E27 W

GXIZ005

8592660100135

biela

27,56 €

TAURUS 2E27 G

GXIZ006

8592660100227

zlatá

29,96 €

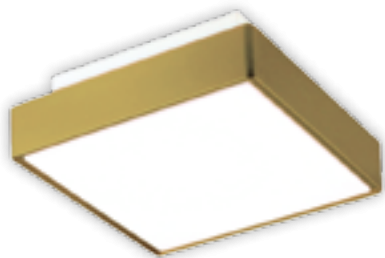

PERSEUS 1E27

Svietidlo žiarivkové prisadené.

Vhodné pre vonkajšie použitie.

Vhodné pro použitie do kúpeľní.

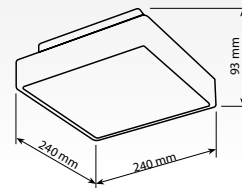
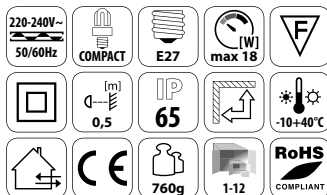

| | | |
|---------------------------|---------|------------|
| Doporučený svetelný zdroj | | DKC |
| SPIRE 15W E27 | GXZK029 | 4,19 € |



PERSEUS 1E27 GR



GXIZ007



8592660100142



šedá

DKC

27,40 €

PERSEUS 1E27 W

GXIZ008

8592660100159

biela

25,80 €

PERSEUS 1E27 G

GXIZ009

8592660100166

zlatá

27,40 €



PERSEUS 2E27

Svietidlo žiarivkové prisadené.

Vhodné pre vonkajšie použitie.

Vhodné pro použitie do kúpeľní.

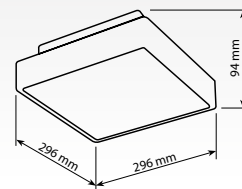
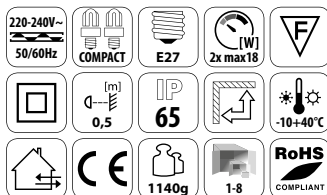

| | | |
|---------------------------|---------|------------|
| Doporučený svetelný zdroj | | DKC |
| SPIRE 15W E27 | GXZK029 | 4,19 € |



PERSEUS 2E27 GR



GXIZ010



8592660100173



šedá

DKC

33,12 €

PERSEUS 2E27 W

GXIZ011

8592660100180

biela

30,76 €

PERSEUS 2E27 G

GXIZ012

8592660100197

zlatá

33,12 €



CETUS 2E27

Svietidlo žiarivkové prisadené.

Vhodné pre vonkajšie použitie.

Vhodné pro použití do koupelny.

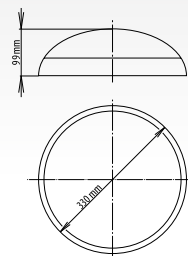
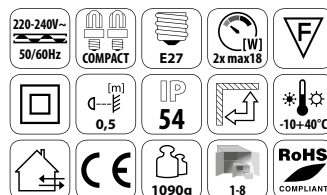

| | | |
|---------------------------|---------|------------|
| Doporučený svetelný zdroj | | DKC |
| SPIRE 15W E27 | GXZK029 | 4,19 € |



CETUS 2E27 GR

CETUS 2E27 W



GXIZ013

GXIZ014



8592660100203

8592660100210



šedá

biela

DKC

26,31 €

24,76 €

ARA E27

Svietidlo žiarivkové prisadené.

Vhodné pre vonkajšie použitie.

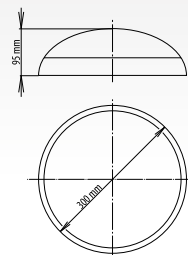

| | | |
|---------------------------|---------|------------|
| Doporučený svetelný zdroj | | DKC |
| SPIRE 15W E27 | GXZK029 | 4,19 € |



ARA E27



GXIZ015



8592660104409



biela



75



1090g

DKC

14,75 €



VELA HF E27

Svietidlo s mikrovlnným senzorom.

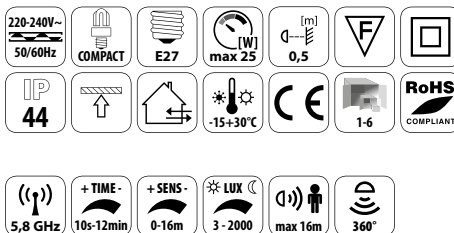
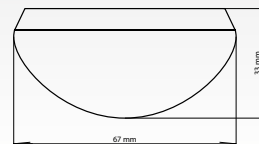

VELA HF E27



GXIZ016



8592660104652



biela

DKC

41,03 €



MANA 2E27

Svietidlo so senzorom.



MANA 2E27



GXIZ017



8592660104669



biela



360



120

DKC

20,50 €



KABINET

Nábytkové žiarivkové svietidlo

- Možnosť priebežného prepojenia svietidiel pomocou prepojovacej šnúry GXIP005
- Všetky svietidlá obsahujú vypínač
- Svietidlo vrátane žiarivky
- Matný prizmatický difúzor

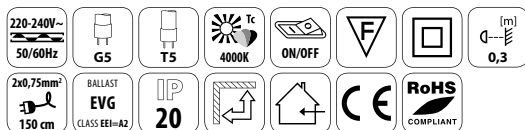
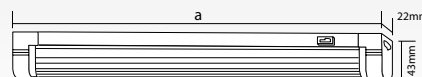

| | | | | | | | | | DKC |
|--------------------|---------|---------------|-------|-----|------|------|------|---------|------------|
| KABINET 8W | GXIP001 | 8592660103761 | biela | 8W | 342 | 255g | 1-30 | 7,27 € | |
| KABINET 13W | GXIP002 | 8592660103778 | biela | 13W | 570 | 350g | 1-30 | 8,42 € | |
| KABINET 21W | GXIP003 | 8592660103785 | biela | 21W | 922 | 485g | 1-20 | 11,73 € | |
| KABINET 28W | GXIP004 | 8592660103792 | biela | 28W | 1203 | 635g | 1-20 | 16,12 € | |

KABINET prepojovací kábel

Prepojovací kábel k nábytkovému žiarivkovému svietidlu

- Prepojovací kábel slúži k priebežnému prepojeniu svietidiel KABINET

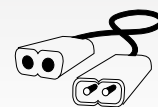



| KABINET 8W | max 18 |
|--------------------|--------|
| KABINET 13W | max 11 |
| KABINET 21W | max 7 |
| KABINET 28W | max 5 |

| | | | DKC |
|-----------------------------------|---------|---------------|------------|
| KABINET prepojovací kábely | GXIP005 | 8592660103808 | 0,73 € |

LEGENDA

OZNAČENIE OCHRANY PRED VZPLANUTÍM



| SYMBOL | Vysvetlení |
|---|--|
|  | Určené k montáži na nehorľavé povrchy (kameň, betón). |
|  | Určené k montáži na normálne horľavé povrchy. Teplota vzplanutia materiálov vyšších ako 200°C. |

TEPLoty CHROMATIČNOSTI



Teplota chromatičnosti T_c [K] sa rovná teplote čierneho žiariča, ktorého žiarenie má takú chromatičnosť ako uvažované zariadenie. Inými slovami sa jedná o objektívnu mieru farby daného svetelného zdroja.

|  |  |
|---|---|
| <2700K | žlto-biela |
| 2700K-3500K | teplá-biela |
| 3500K-5000K | (neutrálna) |
| 5000K-8000K | (studená biela) |
| 8000K-10000K | azúrová (jasné nebo v zime napoludnie) |
| 20000K | azúrová (jasné nebo v lete napoludnie) |
| 28000-30000K | výboj blesku |





OCHRANA PRED ÚRAZOM ELEKTRICKÝM PRÚDOM

| Trieda bezpečnosti | SYMBOL | Vysvetlenie |
|--------------------|---|---|
| 0 | - | Ochrana pred úrazom elektrickým prúdom je založená na základnej izolácii. Ochrana pre úrazom elektrickým prúdom je zaistená okolím a tiež polohou zariadenia. |
| I |  | U zariadení triedy ochrany I je ochrana pred úrazom elektrickým prúdom zaistená pripojením neživých častí k ochrannému vodiču. |
| II |  | Zariadenie triedy ochrany II nemajú prostriedky pre pripojenie ochranného vodiča, sú vybavené prídavnou alebo zosilnenou izoláciou. |
| III |  | Ochrana pred úrazom elektrickým prúdom zariadenia triedy III je založená na napájaní bezpečným malým napätím. |

VYSVETLENIE STUPŇA OCHRANY PRED VNIKNUTÍM PEVNÝCH PREDMETOV

| IP | SYMBOL | Vysvetlenie |
|------|---|---|
| IP0X | - | Nechránené |
| IP1X | - | Zariadenie je chránené pred vniknutím pevných cudzích telies o priemere 50mm a väčších a pred dotykoch chrbátom ruky. |
| IP2X | - | Zariadenie je chránené pred vniknutím pevných cudzích telies o priemere 12,5mm a väčších a pred dotykoch prstom. |
| IP3X | - | Zariadenie je chránené pred vniknutím pevných cudzích telies o priemere 2,5mm a väčších a pred dotykoch nástrojom. |
| IP4X | - | Zariadenie je chránené pred vniknutím pevných cudzích telies o priemere 1mm a väčších a pred dotykoch drôtom. |
| IP5X |  | Čiastočne prachotesné. Zariadenie je chránené pred prachom a pred dotykoch drôtom. |
| IP6X |  | Úplne prachotesné. Zariadenie je prachotesné a je chránené pred dotykoch drôtom. |

VYSVETLENIE STUPŇA OCHRANY PRED VNIKNUTÍM VODY

| IP | SYMBOL | Vysvetlenie |
|------|---|---|
| IPX0 | - | Nechránené. |
| IPX1 | - | Zvisle kvapkajúce. |
| IPX2 | - | Kvapajúce v sklone 15°. |
| IPX3 |  | Vonkajšie prostredie. Kropenie, dážď. |
| IPX4 |  | Tesne zavreté proti striekajúcej vode. Striekajúce. |
| IPX5 |  | Tesne zavreté proti prúdiacej vode. Tryskajúce. |
| IPX6 |  | Do mokra. Intenzívne tryskajúce. |
| IPX7 |  | Nepriepustné, ponorné. Dočasné ponorenie. |
| IPX8 | - | Trvalé ponorenie. |

LEGENDA



DRUH ZDROJA SVETLA:

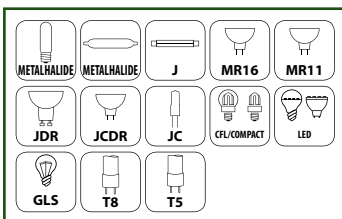

TYP PÄTICE:

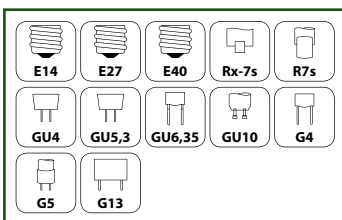

TYP ZAĽAŽENIA SENZORU:



| | | |
|--|--|---|
| názov výrobku | k zabudovaniu do stropu | vybavený vypínačom |
| kód | k montáži na normálne horľavom povrchu | nastavenie času |
| čiarový kód EAN13 | stupeň krytia (IP) | regulácia citlivosti |
| zdroj energie | min. vzdialenosť od osvetľovacieho predmetu | nastaviteľný prah - režim noc / deň |
| príkon | nevyžaduje použitie v uzavretých svietidlách / s ochranným sklom | maximálna vzdialenosť detekcie pohybu |
| I. trieda ochrany pred úrazom el. prúdom | vyžaduje použitie v uzavretých svietidlách / s ochranným sklom | horizontálny uhol detekcie |
| II. trieda ochrany pred úrazom el. prúdom | trieda energetickej účinnosti (Ei) | vertikálny uhol detekcie |
| III. trieda ochrany pred úrazom el. prúdom | energetická trieda predradníka | mikrovlnný senzor |
| teplota chromatičnosti (Tc) | životnosť (h) | účinník (cos φ) |
| index reprodukcie farieb (Ra) | rozsah teploty okolia | elektrická odolnosť izolácie |
| farba | nevhodné pre použitie so stmievačom | typ reflektora - symetrický / asymetrický |
| technológia MCOB LED | vhodné pre použitie so stmievačom | zodpovedajúci výkon |
| technológia LED SMD 5050 | odolnosť proti rýchlemu sledu zapnutia/vypnutia | dĺžka |
| technológia LED SMD 3528 | čas k dosiahnutiu plného svetelného výkonu | hmotnosť |
| technológia LED / POWER LED | vyžarovací uhol | balení |
| k vonkajšiemu alebo vnútornému použitiu | tolerancia pracovnej pozície | množstvo ortuti |
| k vnútornému použitiu | priemer káblu | zhoda so smernicou EU o škodlivých látkach pre životné prostredie a zdravie |
| k vonkajšiemu použitiu | dĺžka odizolovania | zhoda s európskymi normami (CE) |
| k prisadeniu na stenu / strop | dĺžka prívodu | |
| k prisadeniu ku stropu | prívod s vidlicou | |

Čeny uvedené v katalógu sú bez DPH a bez recyklačných poplatkov. Spoločnosť GREENLUX, s.r.o. si vyhradzuje právo na zmeny. Aktuálny sortiment a ceny produktov sú uvedené na www.greenlux.sk. Všetkým sa ospravedľujeme za prípadné tlačové chyby.